

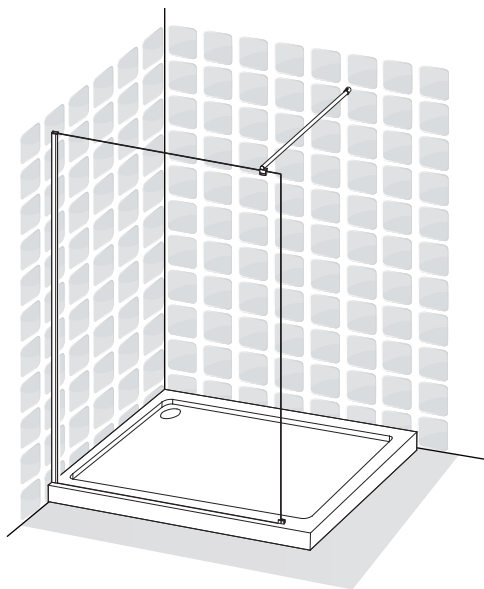

# EASY

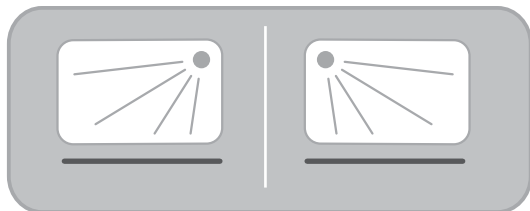

- FR Notice de Montage - Utilisation - Entretien
- ES Instrucciones de Montaje, Utilización y Mantenimiento
- PT Instruções de Montagem, Utilização e Manutenção
- IT Istruzioni per il Montaggio, l'Uso e la Manutenzione
- EL Εγχειρίδιο συναρμολόγησης, χρήσης και συντήρησης
- PL Instrukcja Montażu, Użytkowania i Konserwacji
- RU Руководство По Сборке и Эксплуатации
- UK Керівництво По Збірці і Експлуатації
- RO Manual asamblare, utilizare și întreținere
- EN Assembly - Use - Maintenance Manual



**A****FR** Préparation**ES** Preparación**PT** Preparação**IT** Preparazione**EL** Προετοιμασία**PL** Przygotowanie**RU** Подготовка**UK** Підготовка**RO** Pregătire**EN** Preparation

**FR** Vérifiez que les chevilles murales fournies sont appropriées à votre mur (celles fournies dans l'emballage sont conçues pour le béton). Sinon, utilisez des vis et des chevilles murales adaptées au type de matériau de votre mur. Pour obtenir des conseils concernant les vis et les chevilles appropriées à votre mur, demandez à un vendeur spécialisé.

**ES** Compruebe que todos los tacos suministrados puedan ser utilizados con su pared (los incluidos en la caja son para hormigón). En caso contrario, utilice tornillos y tacos de pared apropiados para el material de su pared. Para información acerca de las fijaciones y tornillos apropiados para su pared, consulte con un asistente de ventas especializado.

**PT** Certifique-se de que as buchas fornecidas são adequadas à sua parede (as fornecidas na embalagem são para betão). Caso contrário, use parafusos e buchas adequados ao tipo de material da sua parede. Para se aconselhar acerca dos parafusos e buchas adequados à sua parede, fale com um assistente de vendas especializado.

**IT** Verificare che i tasselli da parete forniti siano compatibili con la propria parete (quelli forniti con l'articolo sono per cemento). Altrimenti, utilizzare viti e tasselli adatti per la superficie della propria parete. Per ottenere consigli e suggerimenti sulle viti e i tasselli più adatti alla propria parete, consultare un rivenditore specializzato.

**EL** Βεβαιωθείτε ότι οι παρεχόμενες στερεώσεις τοίχου είναι κατάλληλες για τον τοίχο σας (οι παρεχόμενες στη συσκευή προορίζονται για μπετό). Αλλιώς χρησιμοποιήστε βίδες και στερεώσεις τοίχου κατάλληλες για τον τύπο υλικού του τοίχου σας. Για να λάβετε συμβουλές σχετικά με τις κατάλληλες βίδες και τα εξαρτήματα για τον τοίχο σας, ρωτήστε έναν ειδικό πωλητή.

**PL** Prosimy sprawdzić, czy dostarczone kolki do ścian nadają się do użycia w posiadanej ścianie (kolki dostarczone w zestawie są przeznaczone do betonu). Jeśli tak nie jest, należy użyć śrub i kolków odpowiednich do materiału, z którego wykonana jest ściana. Aby uzyskać poradę w sprawie śrub i elementów montażowych odpowiednich do danego typu ściany, należy zwrócić się z pytaniem do wyspecjalizowanego sprzedawcy.

**RU** Убедитесь, что прилагаемые дюбеля подходят для ваших стен (входящие в комплект дюбеля предназначены для бетона). В противном случае используйте шурупы и дюбеля, соответствующие материалу стены. Для получения рекомендаций по выбору шурупов и крепежных деталей, подходящих для вашей стены, обратитесь к специалисту-консультанту.

**UK** Перевірте, що анкери підходять для вашої стіни (ті, що постачаються в упаковці – для бетону). В іншому випадку використовуйте гвинти й стінові анкери, що відповідають матеріалу вашої стіни. Для отримання консультацій щодо гвинтів й фітінгів для вашої стіни зверніться до відповідного продавця-консультанта.

**RO** Verificați ca toate ancorele de perete furnizate să fie adecvate pentru peretele dumneavoastră (cele furnizate în pachet sunt pentru beton). În caz contrar, folosiți șuruburi și ancore de perete adecvate pentru tipul de material din care este peretele dumneavoastră. Pentru a obține recomandări privind șuruburile și armăturile adecvate pentru peretele dumneavoastră, întrebați un vânzător specializat.

**EN** Check that wall anchors provided are suitable for your wall (those provided in the package are for concrete). Otherwise, use screws and wall anchors suited to the type of material of your wall. To obtain advice on the screws and fittings suited to your wall, ask a specialized sales assistant.

EAN CODE :

3276000339090

3276000334194

3276000334200

3276000334217

3276000334262

3276000334279

3276000334286

3276000334293

3276000334347

3276000334354



Attention danger / Atención: Peligro / Atenção perigo / Attenzione pericolo / Προσοχή κίνδυνος / Uwaga niebezpieczeństwo / Внимание! Опасно! / Увага! Небезпечно! / Atenție, pericol / Caution danger



Correct / Correcto / Corretto / Corretto / Σωστό / Dobrze / Правильный / Правильно / Corect / Correct



Incorrect / Incorrecto / Incorretto / Errato / Λάθος / Źle / Неправильный / Неправильно / Incorrec / Incorrect



Sans solvant / Sin disolvente / Sem solventes / Senza solventi / Χωρίς διαλυτικά / Bez rozpuszczalnika / Без растворителя / Без розчинника / Fără solvent / Solvent-free

**Notes / Observaciones / Notas / Note /  
 Σημειώσεις / Notatki / Примечания /  
 Примітки / Note / Notes**

---



---



---



---



---



---

# A

FR Préparation

ES Preparación

PT Preparação

IT Preparazione

EL Προετοιμασία

PL Przygotowanie

RU Подготовка

UK Підготування

RO Pregătire

EN Preparation

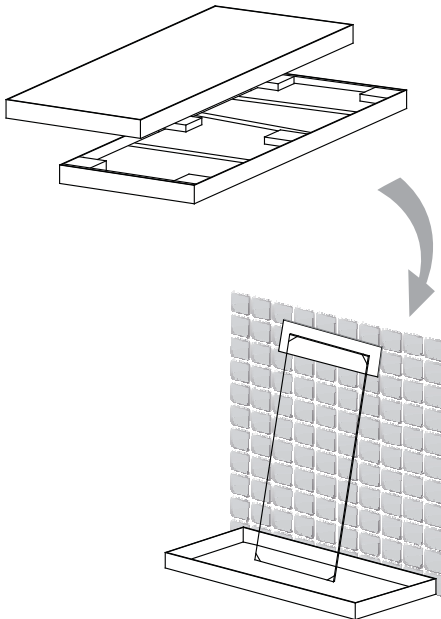
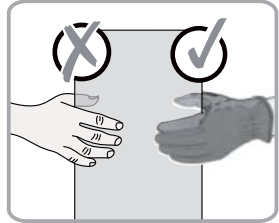
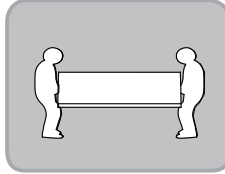
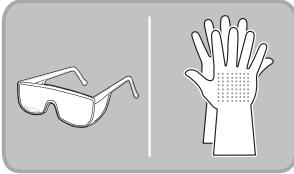
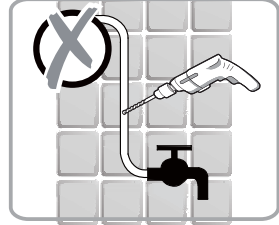
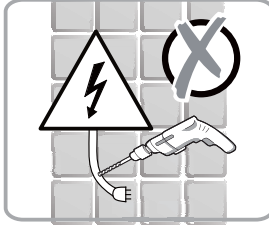
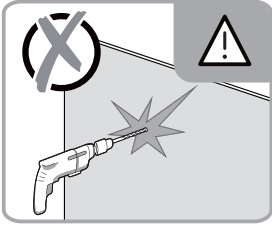

FR Préparation

ES Preparación

PT Preparação

IT Preparazione

EL Προετοιμασία

PL Przygotowanie

RU Подготовка

UK Підготування

RO Pregătire

EN Preparation

A

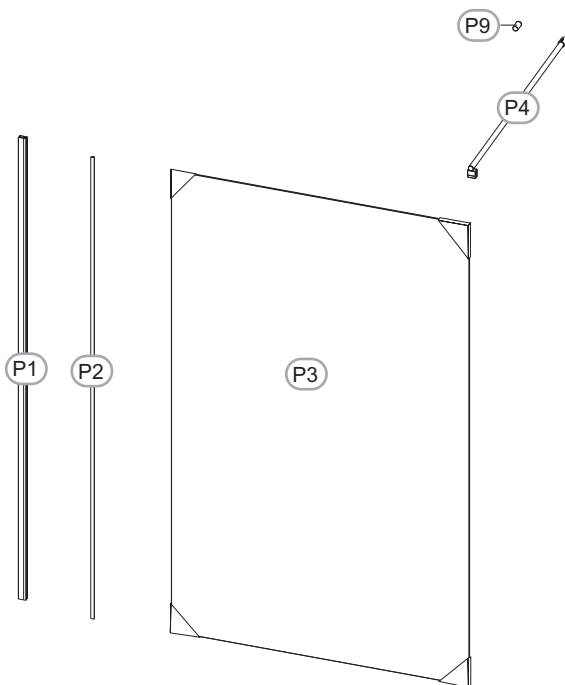
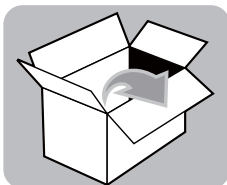

# A

FR Préparation

ES Preparación

PT Preparação

IT Preparazione

EL Προετοιμασία

PL Przygotowanie

RU Подготовка

UK Підготування

RO Pregătire

EN Preparation

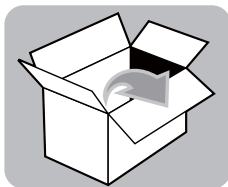

H1



x6

H2



ST4x35mm

x6

H3



x1

H4



x1

H5

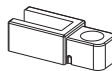

x1

H6



x1

H7



3mm

x1

N



x1

H8



x1

H13



x4

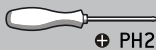
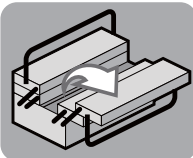

PH2

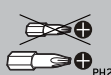

PH2



6mm

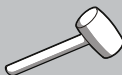

2h

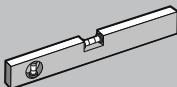
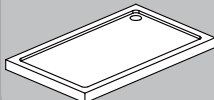

- FR Préparation
- ES Preparación
- PT Preparação
- IT Preparazione
- EL Προετοιμασία
- PL Przygotowanie
- RU Подготовка
- UK Підготування
- RO Pregătire
- EN Preparation

A

EASY	X(mm)
700x1950mm	670~685
800x1950mm	770~785
900x1950mm	870~885
1000x1950mm	970~985
1200x1950mm	1170~1185

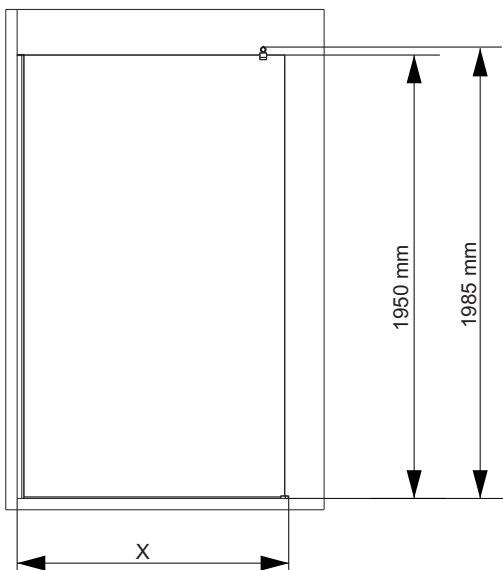
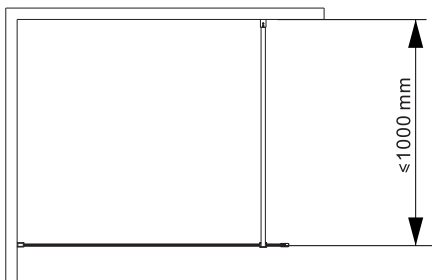

B

FR Montage

ES Montaje

PT Montagem

IT Montaggio

EL Συναρμολόγηση

PL Montaż

RU Сборка

UK Збірка

RO Montaj

EN Assembly

1

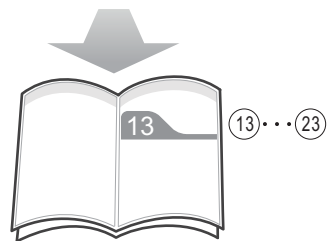
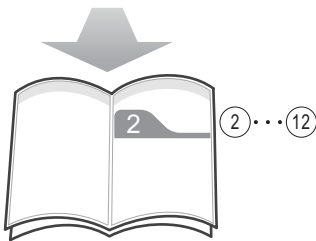
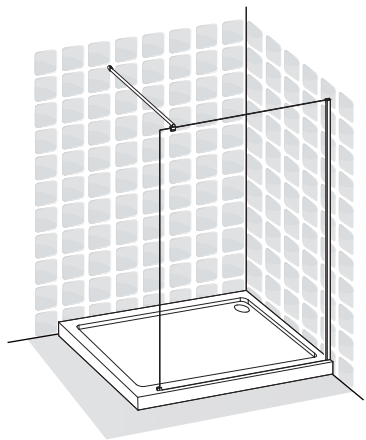
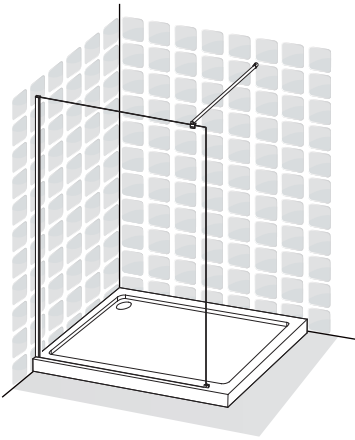



FR Montage

ES Montaje

PT Montagem

IT Montaggio

EL Συναρμολόγηση

PL Montaż

RU Сборка

UK Збірка

RO Montaj

EN Assembly

B

2

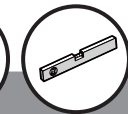
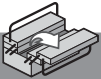
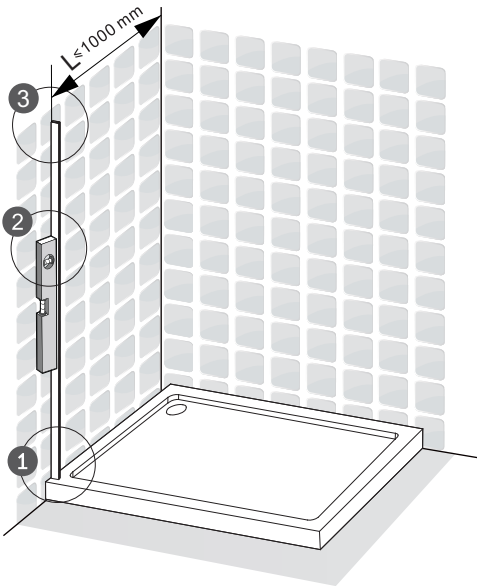
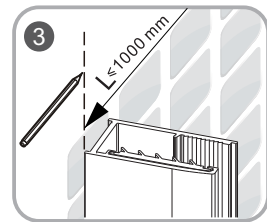
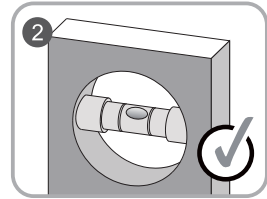
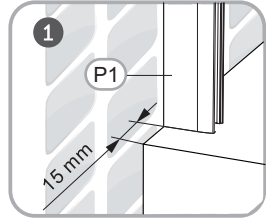
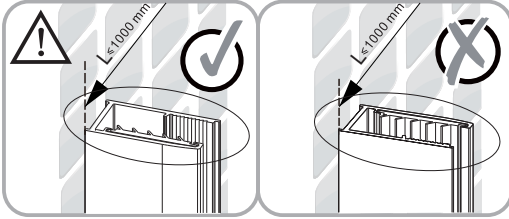

**B**

FR Montage

ES Montaje

PT Montagem

IT Montaggio

EL Συναρμολόγηση

PL Montaż

RU Сборка

UK Збірка

RO Montaj

EN Assembly

3

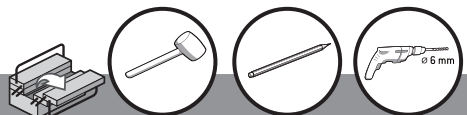
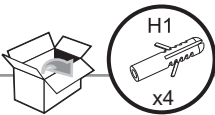
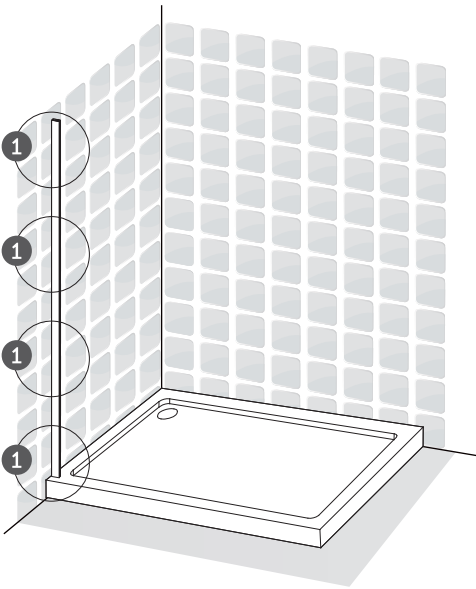
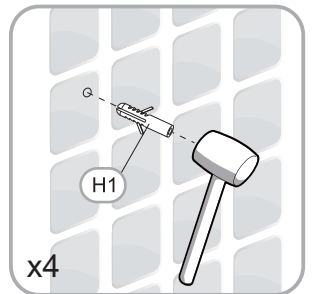
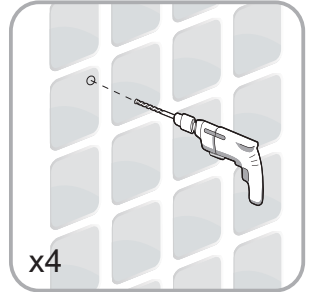
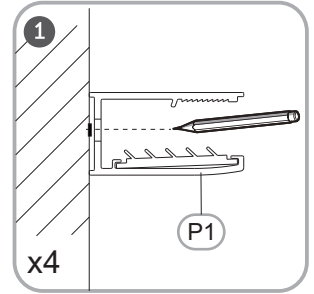
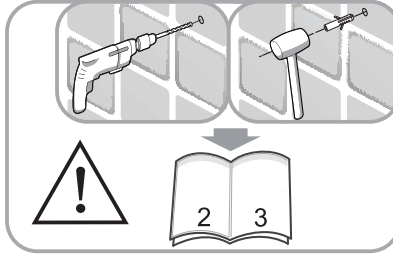

FR Montage

ES Montaje

PT Montagem

IT Montaggio

EL Συναρμολόγηση

PL Montaż

RU Сборка

UK Збірка

RO Montaj

EN Assembly

B

4

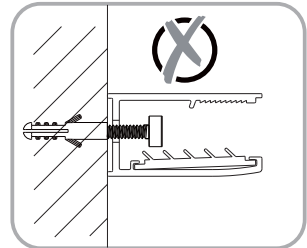
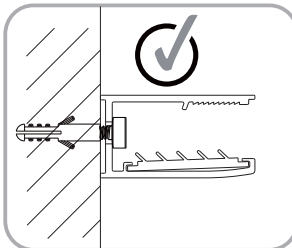
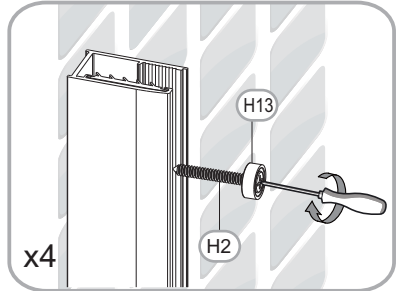
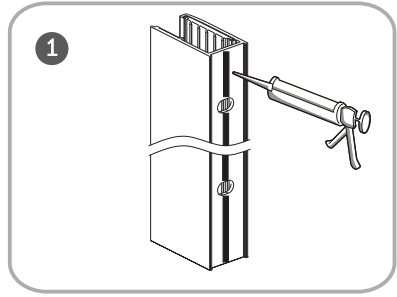
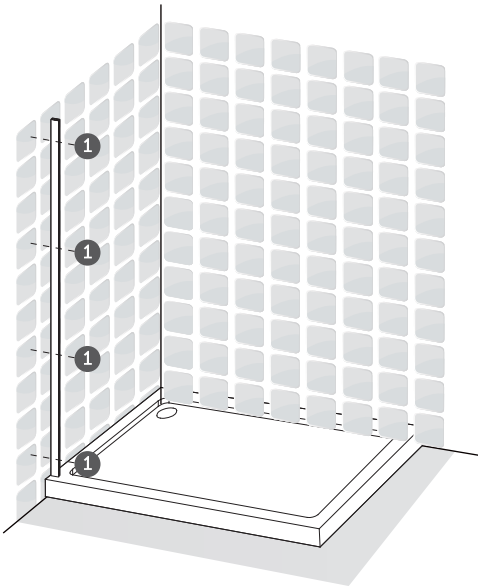

**B**

FR Montage

ES Montaje

PT Montagem

IT Montaggio

EL Συναρμολόγηση

PL Montaż

RU Сборка

UK Збірка

RO Montaj

EN Assembly

5

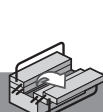
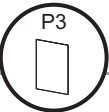
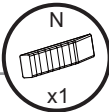
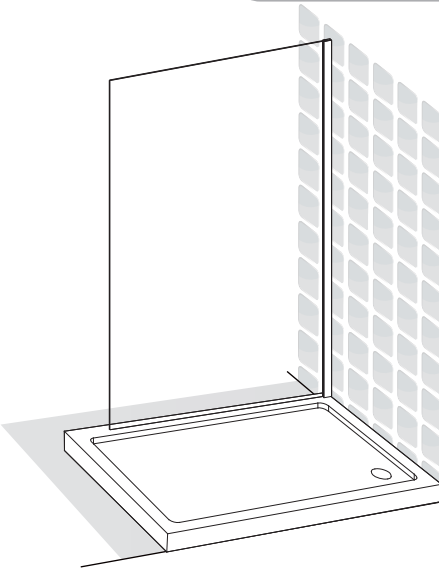
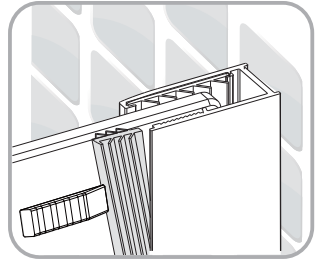
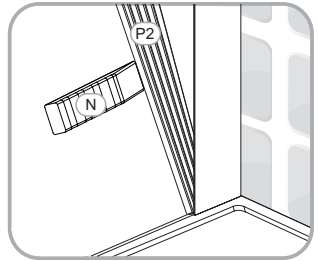
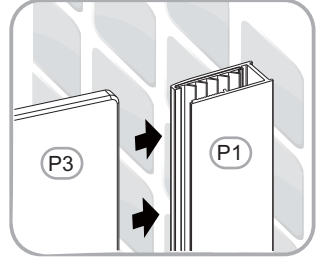
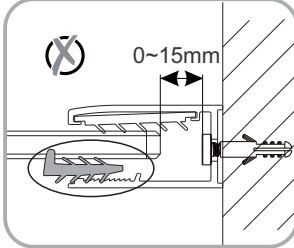
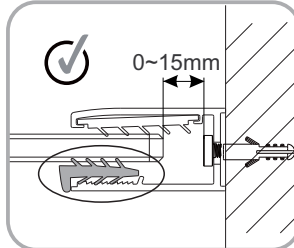
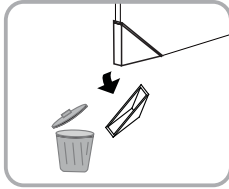
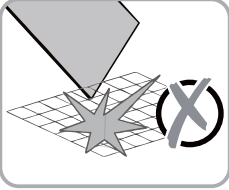

FR Montage

ES Montaje

PT Montagem

IT Montaggio

EL Συναρμολόγηση

PL Montaż

RU Сборка

UK Збірка

RO Montaj

EN Assembly

B

6

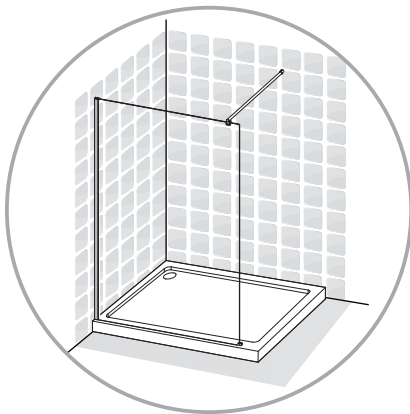

PH2

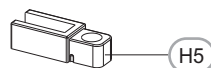
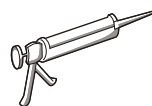
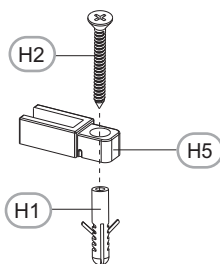

H5

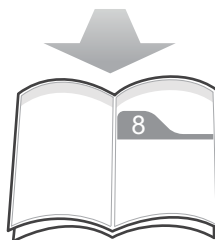
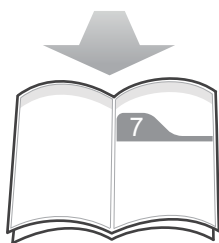

**FR** "Avertissement ! Vérifiez auprès du fabricant du receveur de douche que celui-ci peut être percé. Si ce n'est pas le cas, utilisez du silicone."

**ES** "¡Advertencia! Consulte con el fabricante del plato de la ducha si puede ser perforado. Utilice silicona en caso contrario."

**PT** "Aviso! Pergunte ao fabricante da base de chuveiro se esta pode ser perfurada. Se não for o caso, use silicone."

**IT** "Verificare con il produttore della colonna per la doccia se quest'ultima può essere forata. In caso contrario, utilizzare del silicone."

**EL** "Προειδοποίηση! Ρωτήστε τον κατασκευαστή ντουζιέρας εάν μπορεί να βιδωθεί. Εάν δεν γίνεται, χρησιμοποιήστε σιλικόνη."

**PL** "Ostrzeżenie! Prosimy sprawdzić u producenta brodzika, czy można w nim wierceć otwory. Jeśli nie, należy użyć silikonu."

**RU** "Предупреждение! Узнайте у производителя душевого поддона, допускается ли его сверление. В противном случае используйте силиконовый герметик."

**UK** "Увага! Зверніться до виробника душевого піддона щодо питання сверлення піддона. Якщо це неможливо, використовуйте силікон."

**RO** "Avertizare! Consultați-vă cu producătorul căditei de duș pentru a afla dacă aceasta poate fi găurită. Dacă nu poate fi găurită, utilizați silicon."

**EN** "Warning! Check with shower tray's maker if it can be drilled. If not, use silicon."

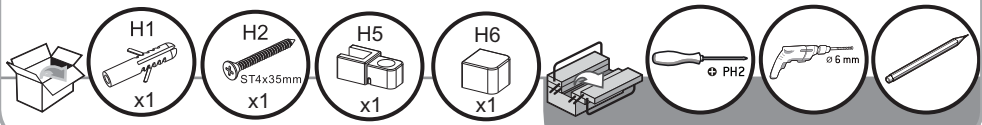
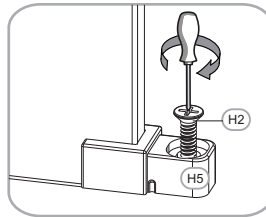
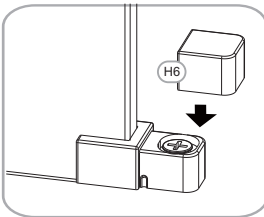
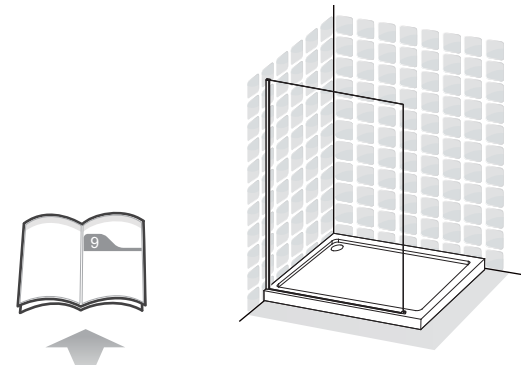
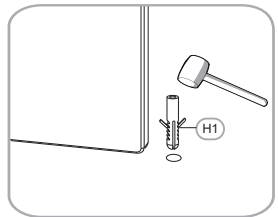
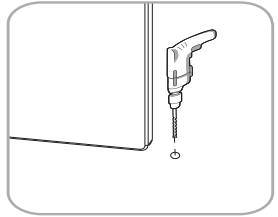
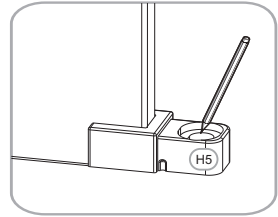
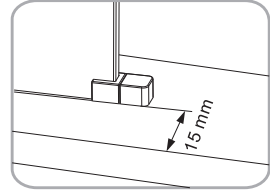

FR Montage

ES Montaje

PT Montagem

IT Montaggio

EL Συναρμολόγηση

PL Montaż

RU Сборка

UK Збірка

RO Montaj

EN Assembly

B

8

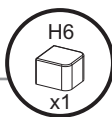
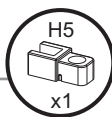
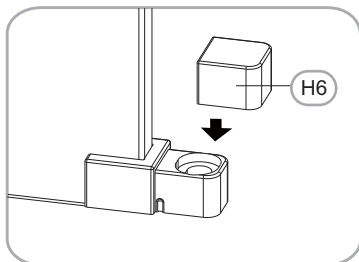
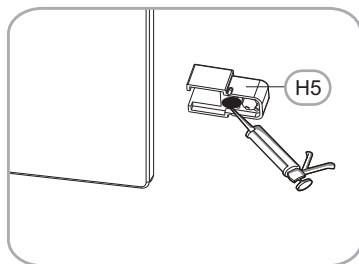
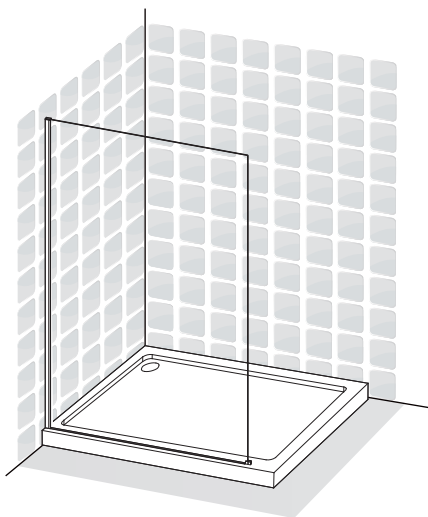
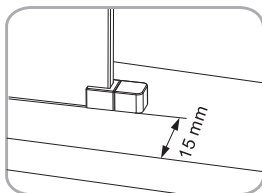

**B**

FR Montage

ES Montaje

PT Montagem

IT Montaggio

EL Συναρμολόγηση

PL Montaż

RU Сборка

UK Збірка

RO Montaj

EN Assembly

9

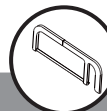
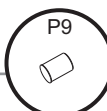
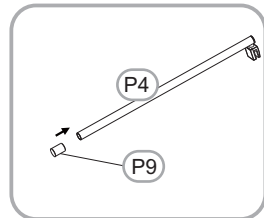
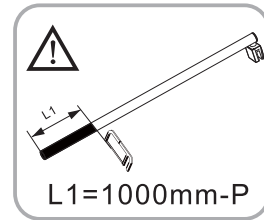
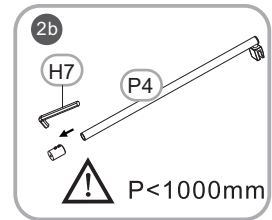
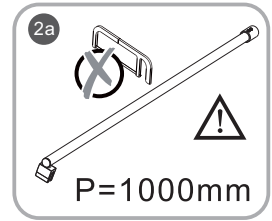
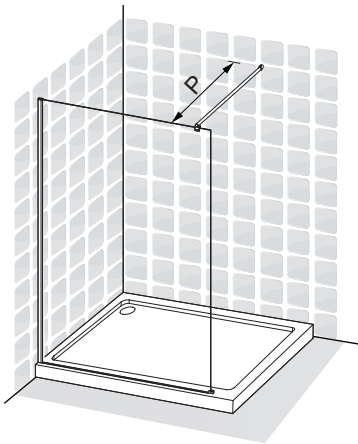
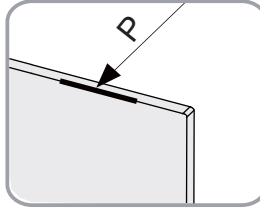
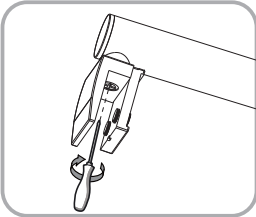
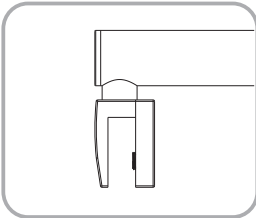
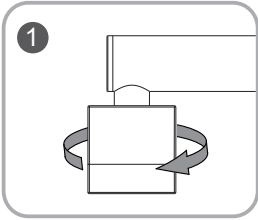



FR Montage

ES Montaje

PT Montagem

IT Montaggio

EL Συναρμολόγηση

PL Montaż

RU Сборка

UK Збірка

RO Montaj

EN Assembly

B

10

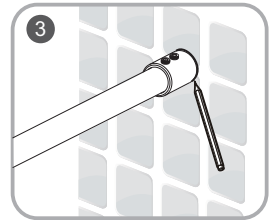
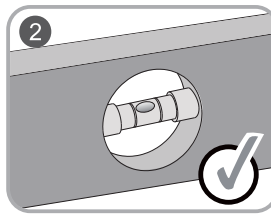
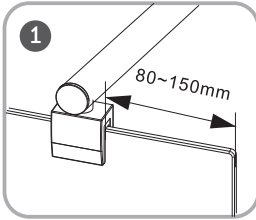

⚠ S=S1

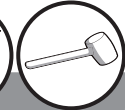
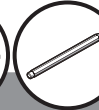
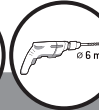
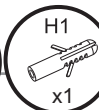
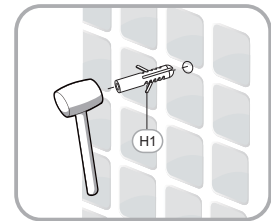
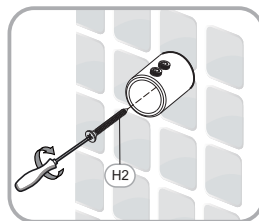
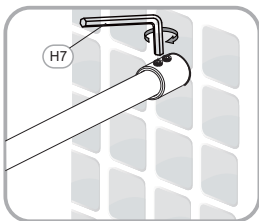
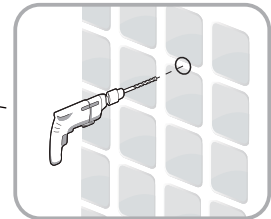
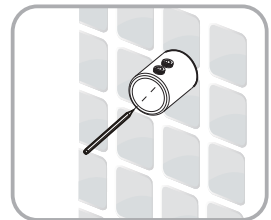
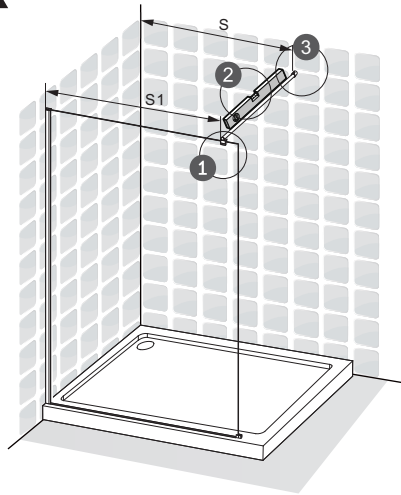
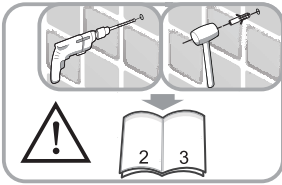

**B**

FR Montage

ES Montaje

PT Montagem

IT Montaggio

EL Συναρμολόγηση

PL Montaż

RU Сборка

UK Збірка

RO Montaj

EN Assembly

11

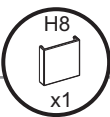
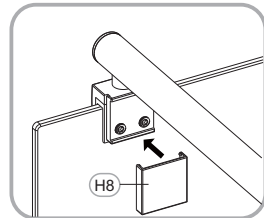
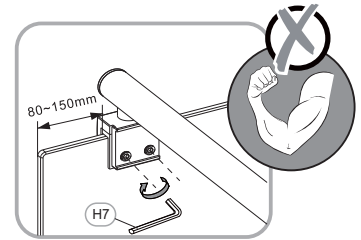
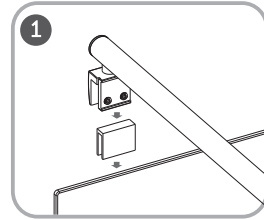
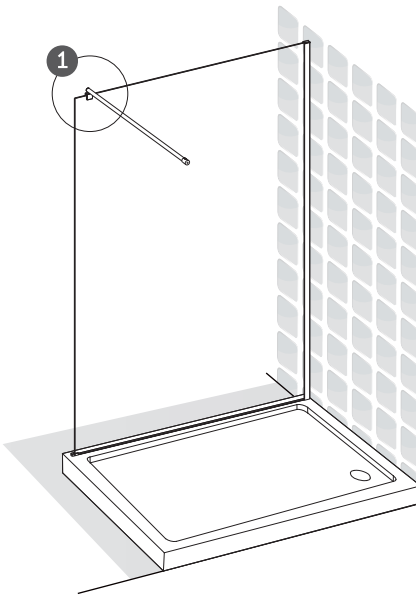

FR Montage

ES Montaje

PT Montagem

IT Montaggio

EL Συναρμολόγηση

PL Montaż

RU Сборка

UK Збірка

RO Montaj

EN Assembly

B

12

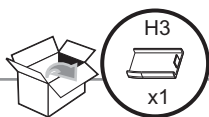
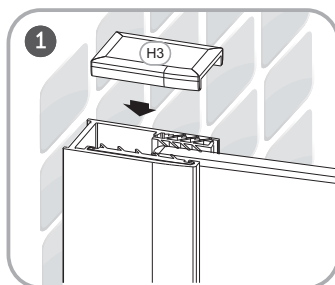
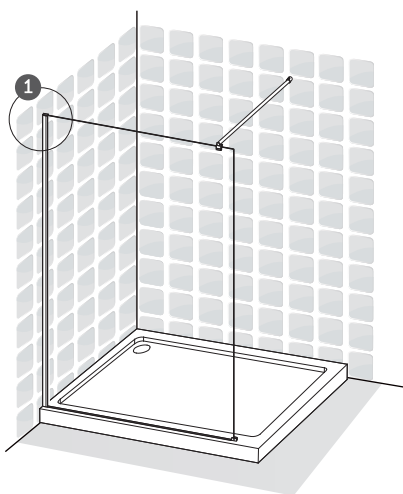

**B**

FR Montage

ES Montaje

PT Montagem

IT Montaggio

EL Συναρμολόγηση

PL Montaż

RU Сборка

UK Збірка

RO Montaj

EN Assembly

13

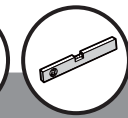
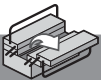
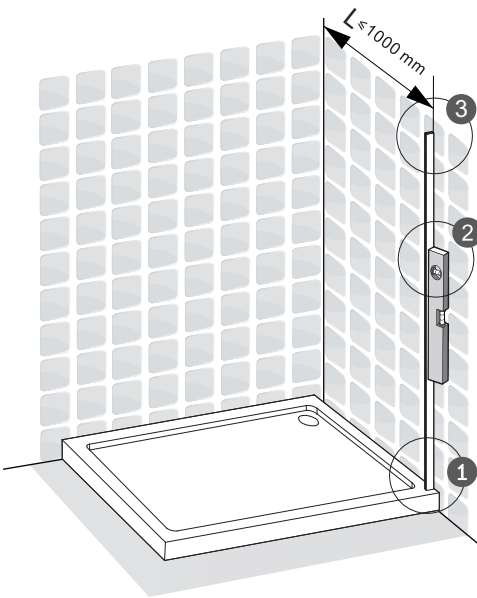
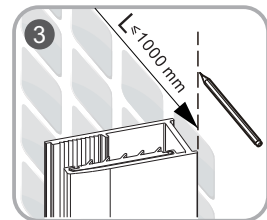
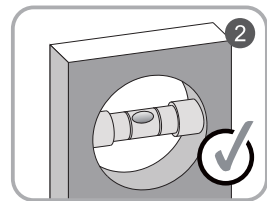
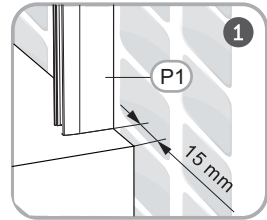
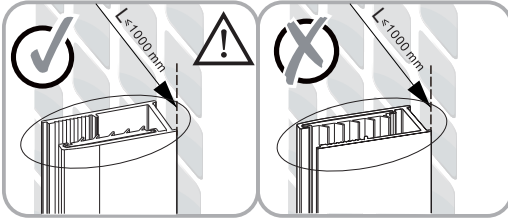

FR Montage

ES Montaje

PT Montagem

IT Montaggio

EL Συναρμολόγηση

PL Montaż

RU Сборка

UK Збірка

RO Montaj

EN Assembly

B

14

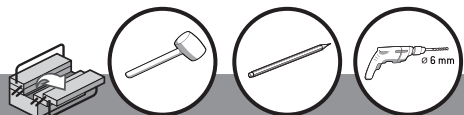
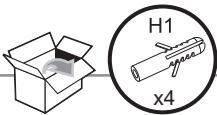
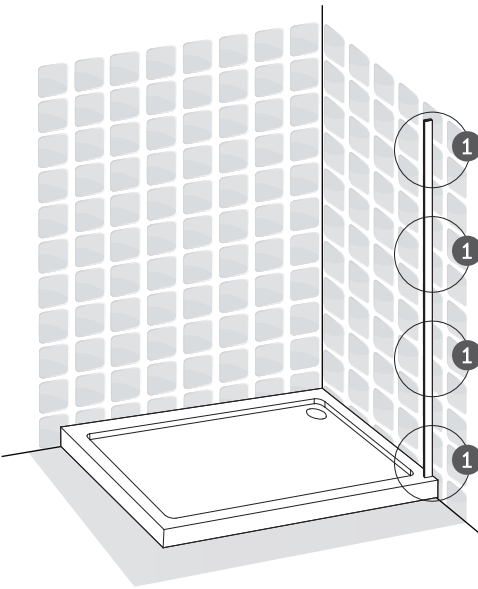
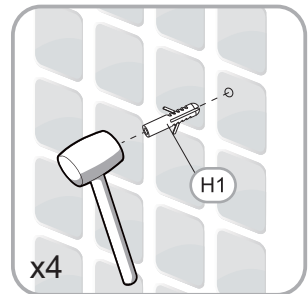
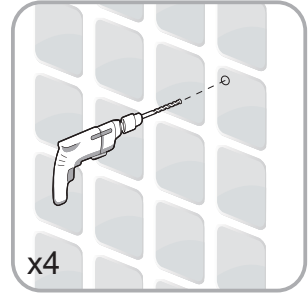
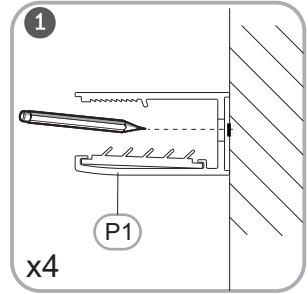
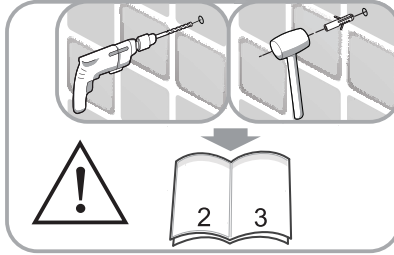

# B

FR Montage

ES Montaje

PT Montagem

IT Montaggio

EL Συναρμολόγηση

PL Montaż

RU Сборка

UK Збірка

RO Montaj

EN Assembly

15

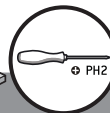
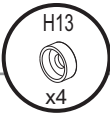
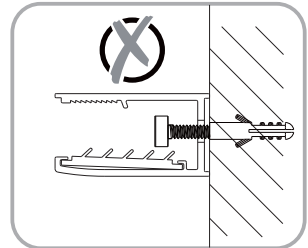
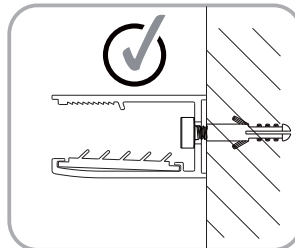
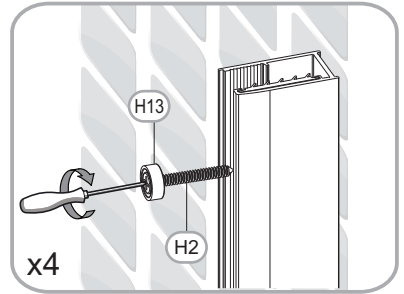
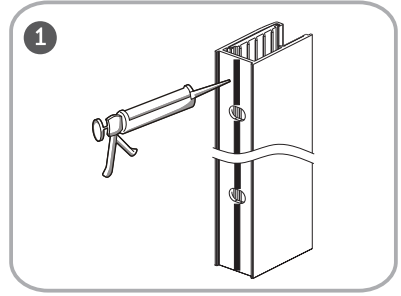
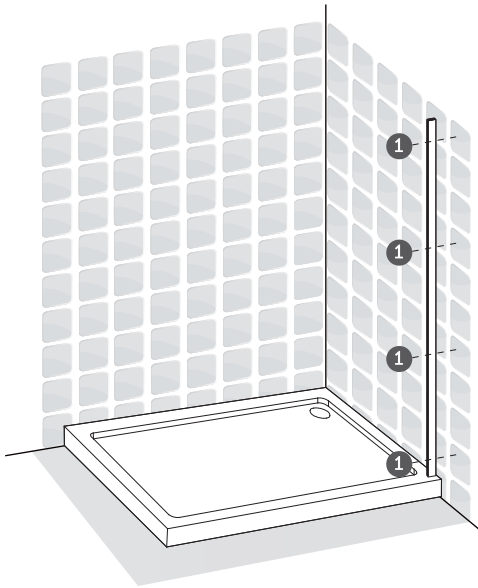

FR Montage

ES Montaje

PT Montagem

IT Montaggio

EL Συναρμολόγηση

PL Montaż

RU Сборка

UK Збірка

RO Montaj

EN Assembly

B

16

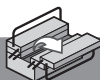
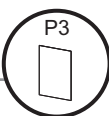
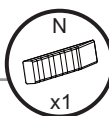
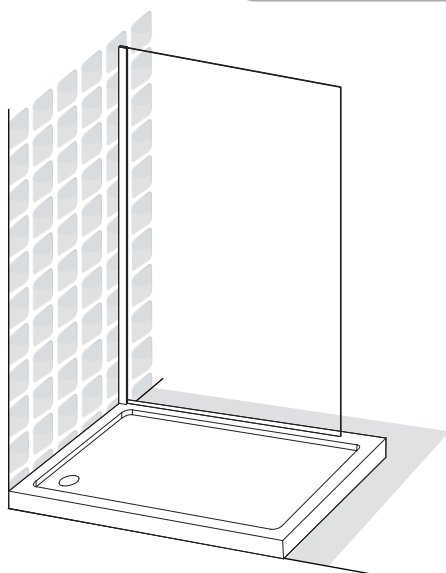
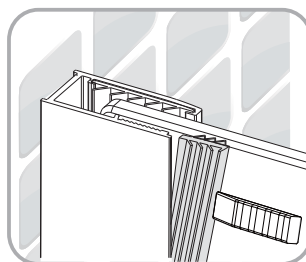
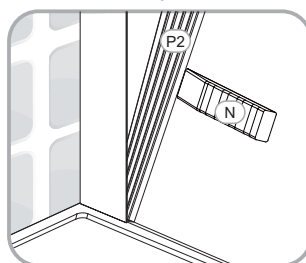
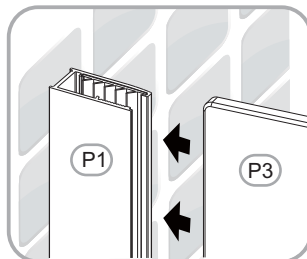
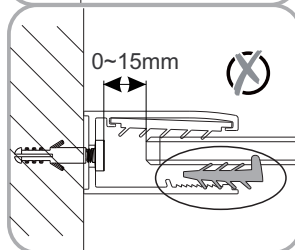
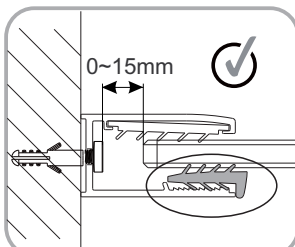
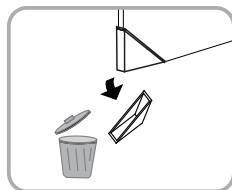
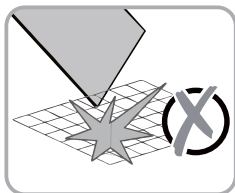

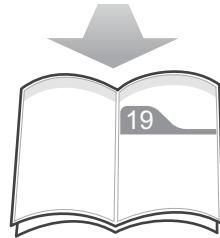
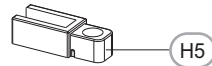
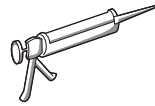
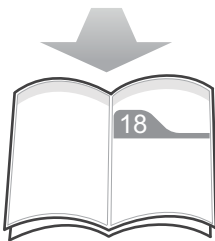
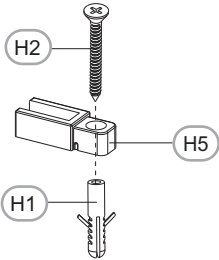
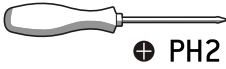
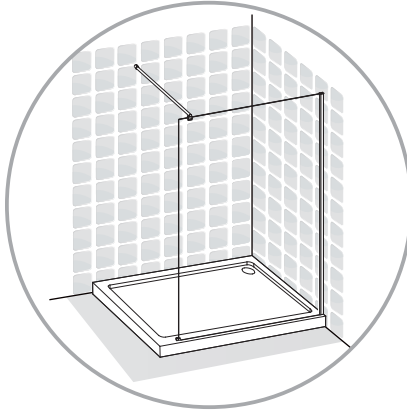



FR Montage

ES Montaje

PT Montagem

IT Montaggio

EL Συναρμολόγηση

PL Montaż

RU Сборка

UK Збірка

RO Montaj

EN Assembly

B

18

FR "Avertissement ! Vérifiez auprès du fabricant du receveur de douche que celui-ci peut être percé. Si ce n'est pas le cas, utilisez du silicone."

ES "¡Advertencia! Consulte con el fabricante del plato de la ducha si puede ser perforado. Utilice silicona en caso contrario."

PT "Aviso! Pergunte ao fabricante da base de chuveiro se esta pode ser perfurada. Se não for o caso, use silicone."

IT "Verificare con il produttore della colonna per la doccia se quest'ultima può essere forata. In caso contrario, utilizzare del silicone."

EL "Προειδοποίηση! Ρωτήστε τον κατασκευαστή ντουζιέρας εάν μπορεί να βιδωθεί. Εάν δεν γίνεται, χρησιμοποιήστε σιλικόνη."

PL "Ostrzeżenie! Prosimy sprawdzić u producenta brodzika, czy można w nim wiercić otwory. Jeśli nie, należy użyć silikonu."

RU "Предупреждение! Узнайте у производителя душевого поддона, допускается ли его сверление. В противном случае используйте силиконовый герметик."

UK "Увага! Зверніться до виробника душевого піддона щодо питання сверлення піддона. Якщо це неможливо, використовуйте силікон."

RO "Avertizare! Consultați-vă cu producătorul cădiței de duș pentru a afla dacă această poate fi găurită. Dacă nu poate fi găurită, utilizați silicon."

EN "Warning! Check with shower tray's maker if it can be drilled. If not, use silicon."

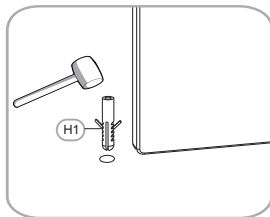
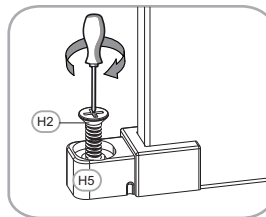
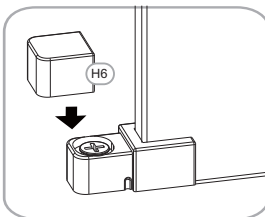
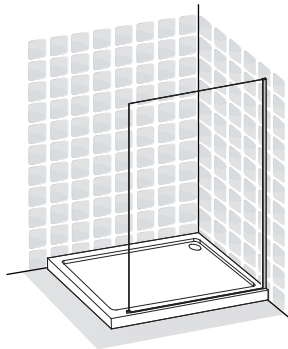
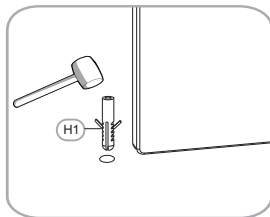
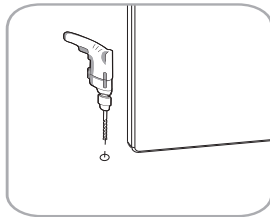
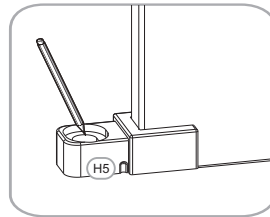
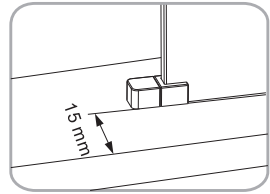

**B**

FR Montage

ES Montaje

PT Montagem

IT Montaggio

EL Συναρμολόγηση

PL Montaż

RU Сборка

UK Збірка

RO Montaj

EN Assembly

19

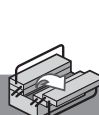
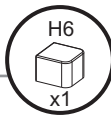
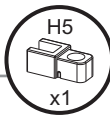
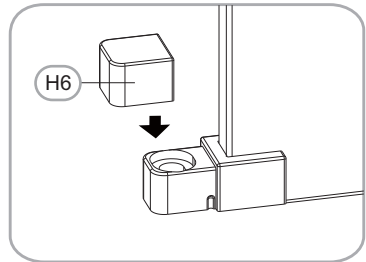
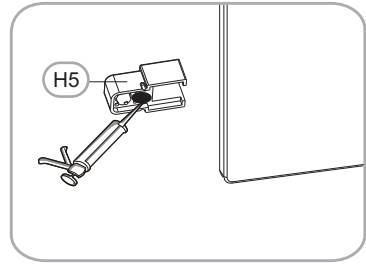
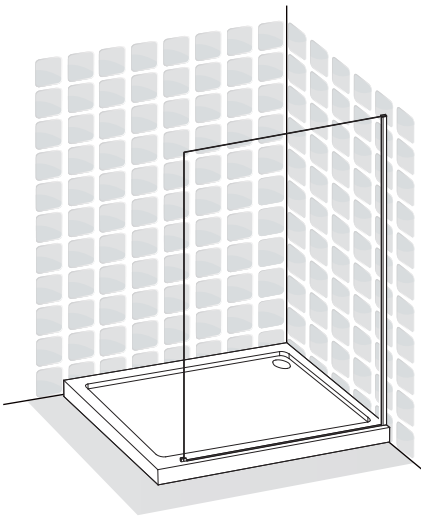
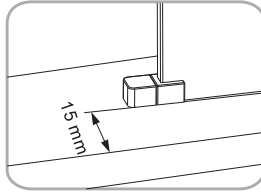

FR Montage

ES Montaje

PT Montagem

IT Montaggio

EL Συναρμολόγηση

PL Montaż

RU Сборка

UK Збірка

RO Montaj

EN Assembly

B

20

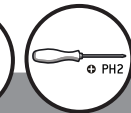
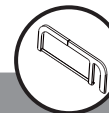
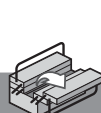
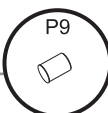
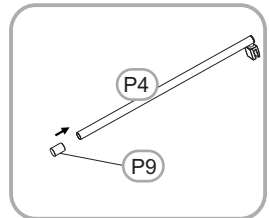
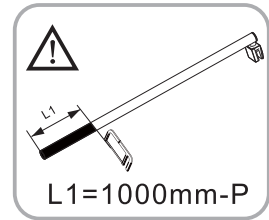
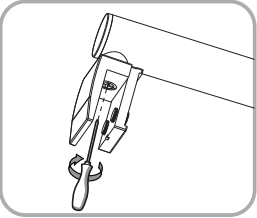
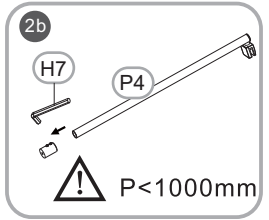
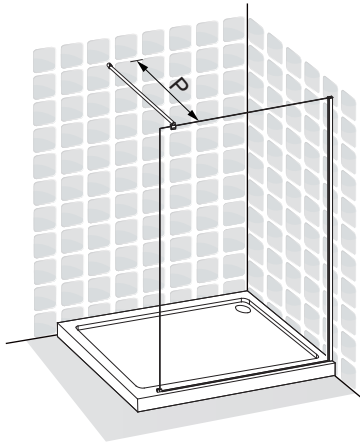
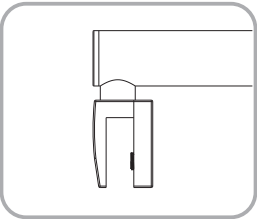
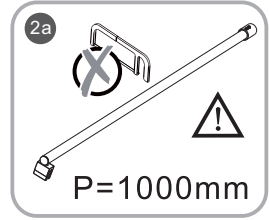
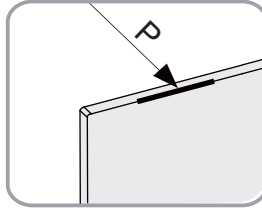
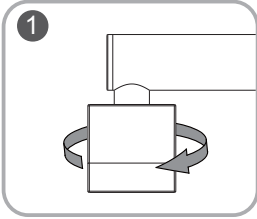

**B**

FR Montage

ES Montaje

PT Montagem

IT Montaggio

EL Συναρμολόγηση

PL Montaż

RU Сборка

UK Збірка

RO Montaj

EN Assembly

21

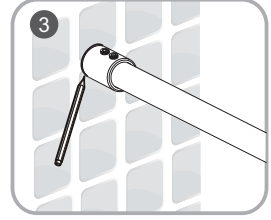
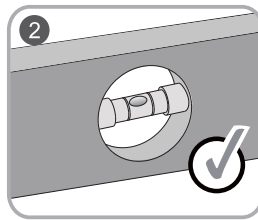
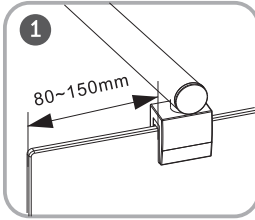

⚠ S=S1

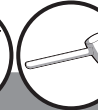
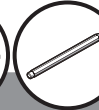
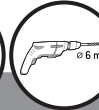
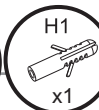
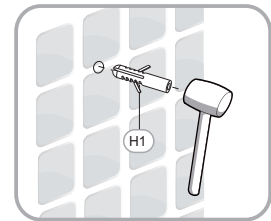
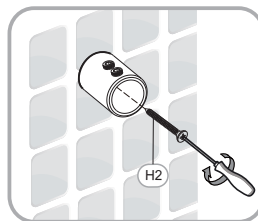
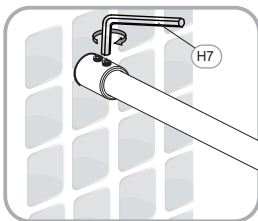
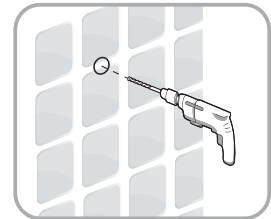
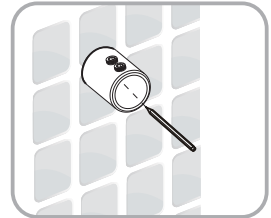
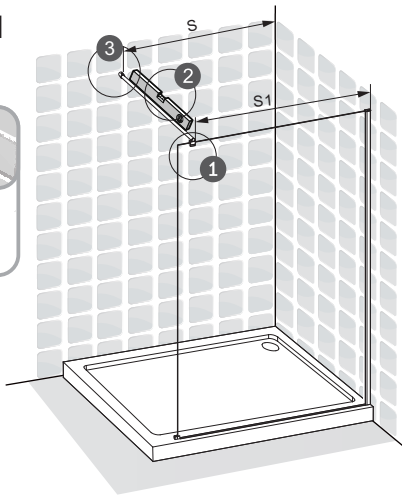
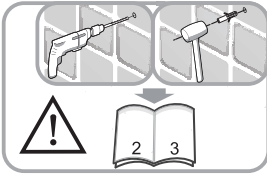

FR Montage

ES Montaje

PT Montagem

IT Montaggio

EL Συναρμολόγηση

PL Montaż

RU Сборка

UK Збірка

RO Montaj

EN Assembly

B

22

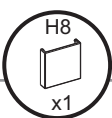
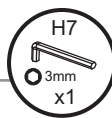
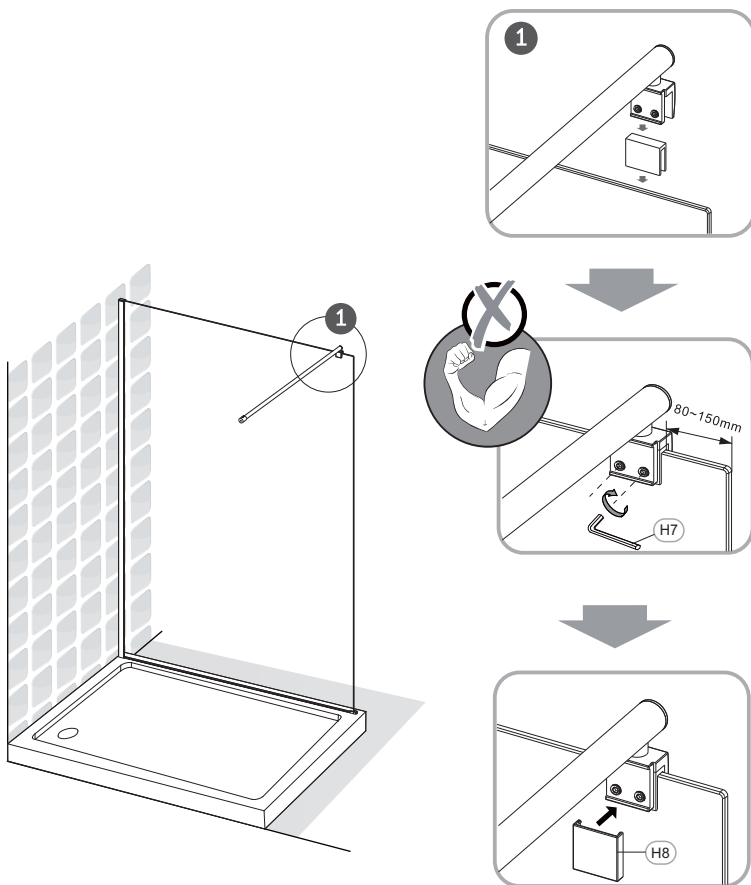

**B****FR** Montage**ES** Montaje**PT** Montagem**IT** Montaggio**EL** Συναρμολόγηση**PL** Montaż**RU** Сборка**UK** Збірка**RO** Montaj**EN** Assembly

23

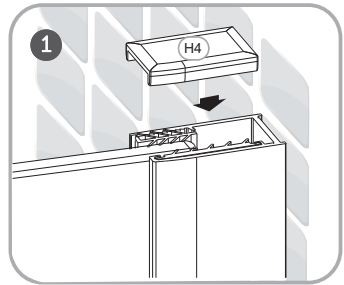
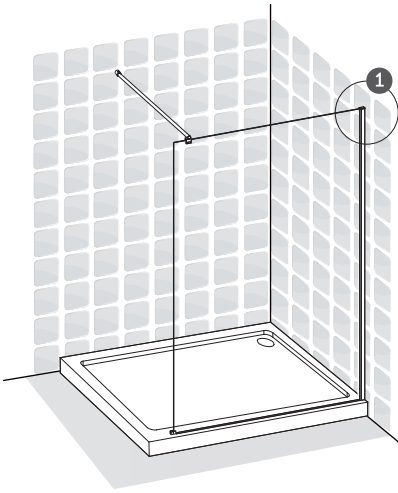

FR Montage

ES Montaje

PT Montagem

IT Montaggio

EL Συναρμολόγηση

PL Montaż

RU Сборка

UK Збірка

RO Montaj

EN Assembly

B

24

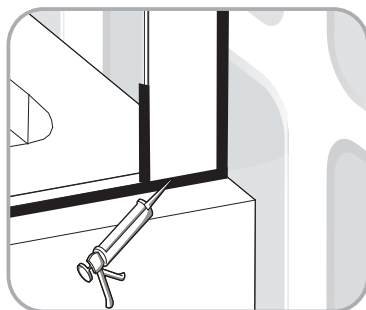
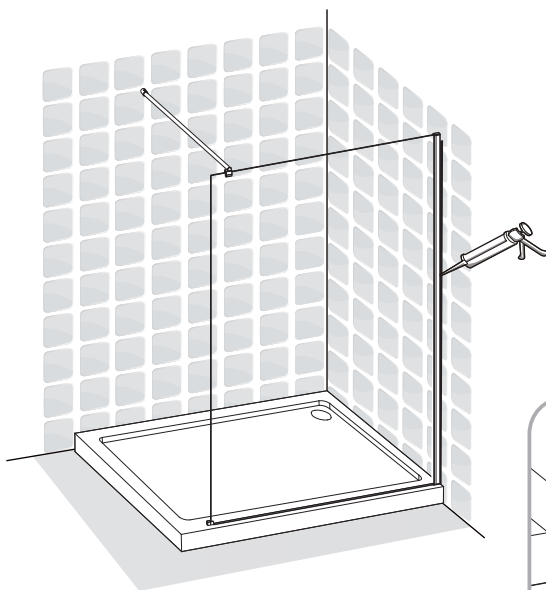
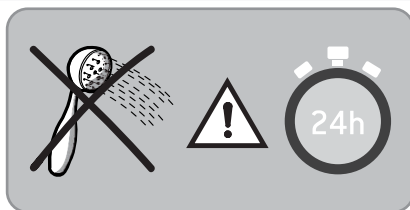

**B**

FR Montage

ES Montaje

PT Montagem

IT Montaggio

EL Συναρμολόγηση

PL Montaż

RU Сборка

UK Збірка

RO Montaj

EN Assembly

25

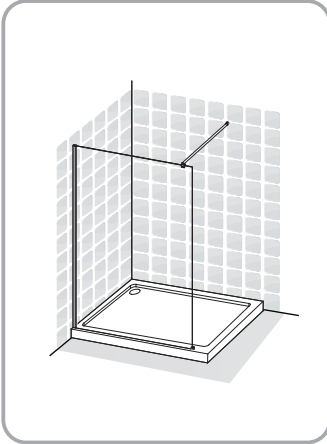

+

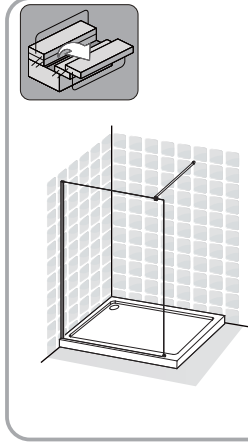

+



EAN CODE	COLOR
3276000334422	SILVER

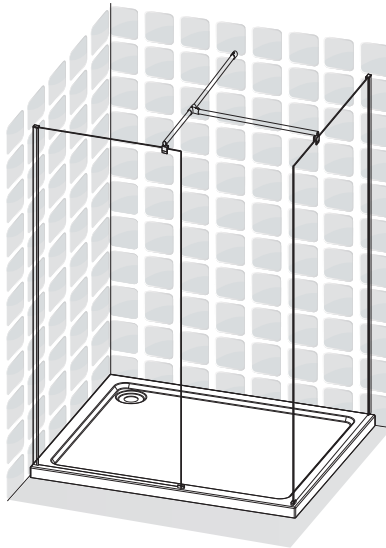



FR Montage

ES Montaje

PT Montagem

IT Montaggio

EL Συναρμολόγηση

PL Montaż

RU Сборка

UK Збірка

RO Montaj

EN Assembly

B

26

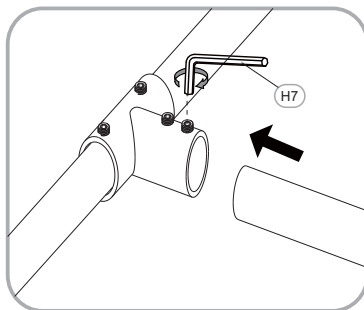
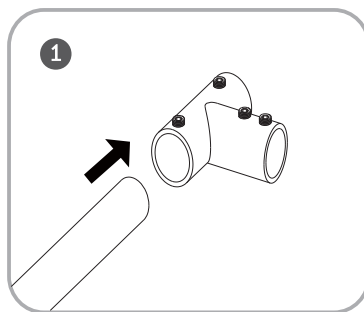
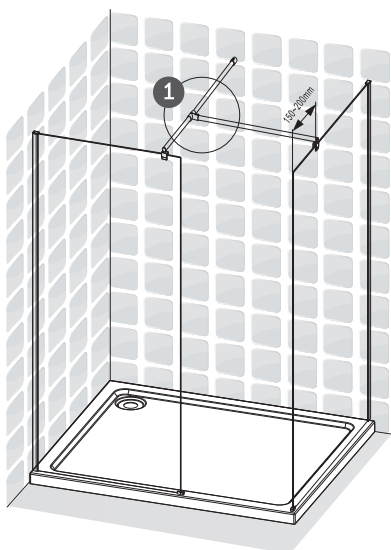

**C****FR** Entretien**ES** Mantenimiento**PT** Serviço**IT** Manutenzione**EL** Συντήρηση**PL** Konserwacja**RU** Уход**UK** Догляд**RO** Întreținere**EN** Maintenance

Sans solvant / Sin disolvente / Sem solventes / Senza solventi / Χωρίς διαλυτικά / Bez rozpuszczalnika / Без растворителя / Без розчинника / Fără solvent / Solvent-free

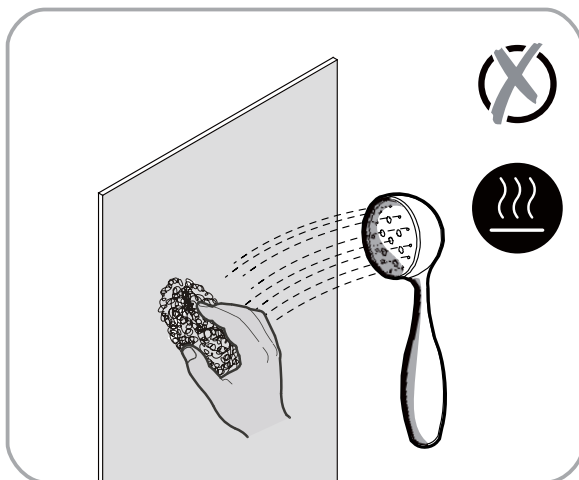
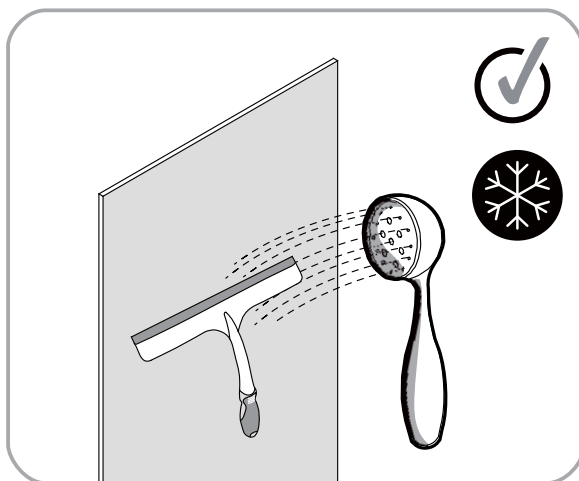

**FR**



ADEO Services - 135 Rue Sadi Carnot - CS 00001 59790 RONCHIN - France  
17  
EN 14428:2015

Code d'identification unique du produit type: \*\*  
usage prévu: hygiène personnelle  
Nettoyable: Conforme  
Résistance à l'impact/  
Capacité de Fragmentation: Conforme  
durabilité: Conforme

DOP N° \*

**ES**



ADEO Services - 135 Rue Sadi Carnot - CS 00001 59790 RONCHIN - France  
17  
EN 14428:2015

Código de identificación única del producto tipo: \*\*  
Uso previsto: higiene personal  
Limpiable: Conforme  
Resistencia al impacto/  
Capacidad de fragmentación: Conforme  
Durabilidad: Conforme

DOP N° \*

**PT**



ADEO Services - 135 Rue Sadi Carnot - CS 00001 59790 RONCHIN - France  
17  
EN 14428:2015

Código de identificação único do produto-tipo: \*\*  
Utilização prevista: higiene pessoal  
Limpeza: Conforme  
Resistência ao impacto/  
Capacidade de fragmentação: Conforme  
Durabilidade: Conforme

DOP N° \*

**IT**



ADEO Services - 135 Rue Sadi Carnot - CS 00001 59790 RONCHIN - France  
17  
EN 14428:2015

Codice di identificazione unico del prodotto-tipo: \*\*  
Uso previsto: igiene personale  
Pulibile: Conforme  
Resistenza agli urti/  
Capacità di Frammentazione: Conforme  
Durata: Conforme

DOP N° \*

**EL**



ADEO Services - 135 Rue Sadi Carnot - CS 00001 59790 RONCHIN - France  
17  
EN 14428:2015

Μοναδικός κωδικός ταυτοποίησης του τύπου του προϊόντος: \*\*  
προβλεπόμενη χρήση: προσωπική υγιεινή  
Δυνατότητα καθαρισμού: Σύμφωνα με  
Αντοχή σε κρούση/ Ικανότητα κατάτμησης: Σύμφωνα με  
Διάρκεια: Σύμφωνα με

DOP N° \*

**PL**



ADEO Services - 135 Rue Sadi Carnot - CS 00001 59790 RONCHIN - France  
17  
EN 14428:2015

Niepowtarzalny kod identyfikacyjny typu wyrobu: \*\*  
przeznaczenie: higiena osobista  
Możliwość czyszczenia: Zgodny  
Odporność na uderzenia/  
Rozkruszalność: Zgodny  
Trwałość: Zgodny

DOP N° \*

**RU**



ADEO Services - 135 Rue Sadi Carnot - CS 00001 59790 RONCHIN - France  
17  
EN 14428:2015

Уникальный идентификационный код типа изделия: \*\*  
Назначение: личная гигиена  
Легкость очистки: Соответствие  
Ударопрочность/  
Мощность распыления: Соответствие  
Долговечность: Соответствие

DOP N° \*

**UK**



ADEO Services - 135 Rue Sadi Carnot - CS 00001 59790 RONCHIN - France  
17  
EN 14428:2015

Унікальний ідентифікаційний код виду продукції: \*\*  
призначення: особиста гігієна  
Легкість очищення: Відповідність  
Ударостійкість/  
Потужність розпилення: Відповідність  
Довговічність: Відповідність

DOP N° \*

**RO**



ADEO Services - 135 Rue Sadi Carnot - CS 00001 59790 RONCHIN - France  
17  
EN 14428:2015

Cod unic de identificare a tipului de produs: \*\*  
destinație: igienă personală  
Rezistență la impact/  
Capacitate de fragmentare: Conform  
Durabilitate: Conform

DOP N° \*

**EN**



ADEO Services - 135 Rue Sadi Carnot - CS 00001 59790 RONCHIN - France  
17  
EN 14428:2015

Unique identification code of the product-type: \*\*  
Intended use: personal hygiene  
cleanability: Pass  
Impact resistance/ shatter properties: Pass  
Durability: Pass

DOP N° \*

\*\*

**FR** Reportez-vous à l'annexe.

**ES** Consulte el apéndice.

**PT** Consulte o anexo.

**IT** Consultare l'appendice.

**EL** Ανατρέξτε στο Παράρτημα.

**PL** Patrz załącznik.

**RU** См. приложение.

**UK** Читайте додаток.

**RO** Consultați anexa.

**EN** Refer to appendix.

\* Garantie 2 ans / Garantía 2 años / Garantia 2 anos / Garanzia 2 anni  
Εγγύηση 2 ετών / Gwarancja 2 lat / 2 летняя / 2-річна гарантія  
2 ani garanție / Guarantee 2 years

**FR** ADEO Services - 135 Rue Sadi Carnot - CS 00001  
59790 RONCHIN - France

**RU** ООО ЛЕРУА МЕРЛЕН ВОСТОК, 141031, Московская область,  
Мытищинский район, г. Мытищи, Осташковское шоссе,  
д.1, РОССИЯ

**UA** ТОВ «Леруа Мерлен Україна»,  
вул. Полярна 17а, м. Київ 04201, Україна

Made in P.R. C. 2017