

delinia

Guarantee
10
years

HUGO

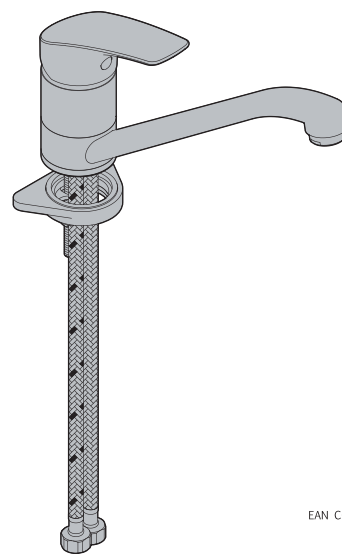

EAN CODE:3276000592327
3276000592419
3276000596257
3276000592358
3276000597391
3276000597407
3276000597414
3276000632344

- | | | | |
|-------------------------------------|-----------------------------------|---------------------------------------|----------------------------------|
| FR Manuel d'Instructions | ES Manual de Instrucciones | PT Manual de Instruções | IT Manuale di Istruzioni |
| EL Εγχειρίδιο Οδηγιών | PL Instrukcja Obsługi | RU Руководство по Эксплуатации | KZ Пайдаланушы Нұсқаулығы |
| UA Інструкція з Експлуатації | RO Manual de Instrucțiuni | BR Manual de Instruções | EN Instructions Manual |

2022/05-V04

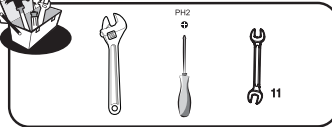
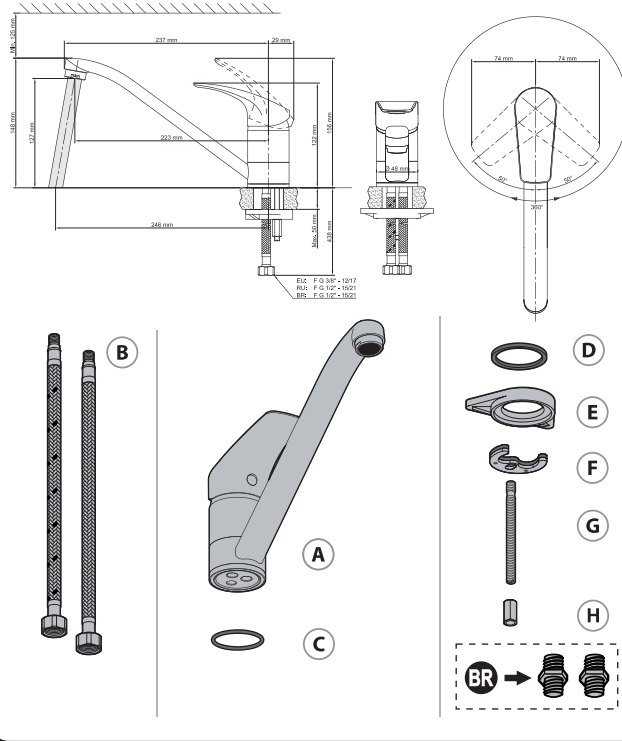



FR: Préparation / ES: Preparación / PT: Preparação / IT: Preparazione / EL: Προετοιμασία /
PL: Przygotowanie / RU: Подготовка / KZ: Дайындау / UA: Підготовка / RO: Pregătire / BR: Preparação /
EN: Preparation

 4



FR: Montage / ES: Montaje / PT: Montagem / IT: Montaggio / EL: Συνορμολόγηση /
PL: Montaż / RU: Сборка / KZ: Монтаждау / UA: Збірка / RO: Montaj / BR: Montagem /
EN: Assembly

 5 → 7



FR: Utilisation eau chaude-eau froide/ ES: Utilización agua caliente-agua fría/ PT: Utilização água quente-água fria/
IT: Uso acqua calda-acqua fredda/ EL: Χρήση ζεστού-κρύου νερού/ PL: Użytkowanie zimnej-gorącej wody/
RU: использование горячей и холодной воды/ KZ: Суық және ыстық суды қолдану/
UA: використання гарячої - холодної води/ RO: Utilizare apă caldă-apă rece/ BR: Uso de água quente e fria/
EN: Using hot and cold water

 8

FR: Changement de cartouche/ ES: Cambio de cartucho/ IT: Cambio cartuccia/ PT: Mudança de cartucho/
EL: Αλλαγή φιοφυγίου/ PL: Wymiana wkładu / RU: Замена картриджа/ KZ: Картриджі ауыстыру/
UA: Заміна картриджа/ RO: Schimbare cartuş/ BR: Substituição de cartucho/ EN: Replacing the cartridge

 9 → 12

FR: Changement de mousseur/ ES: Cambio de aireador/ PT: Mudança de arejador/ IT: Cambio rompigetto/
EL: Αλλαγή αεράτορα/ PL: Wymiana perlatora / RU: Замена аэратора/ KZ: Ауақаның тырғышты ауыстыру/
UA: Заміна аератора/ RO: Schimbare aerator/ BR: Substituição do aerador/ EN: Replacing the aerator

 13

FR: Changement de flexibles/ ES: Cambio de flexibles / PT: Mudança de flexíveis/ IT: Cambio flessibili/
EL: Αλλαγή λάστιχων/ PL: Wymiana wężyków instalacyjnych / RU: Замена гибкого шланга для смесителя/
UA: Заміна гнучкого шланга для змішувача/ KZ: Қоспауауышқа арналған иілгіш шлангты ауыстыру/
RO: Schimbare furtune flexibile/ BR: Substituição das mangueiras/ EN: Replacing the hoses

 14 → 15



FR: Préparation / ES: Preparación / PT: Preparação / IT: Preparazione / EL: Προετοιμασία /
PL: Przygotowanie / RU: Подготовка / KZ: Дайындау / UA: Підготовка / RO: Pregătire /
BR: Preparação / EN: Preparation

1

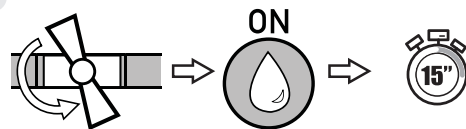

2

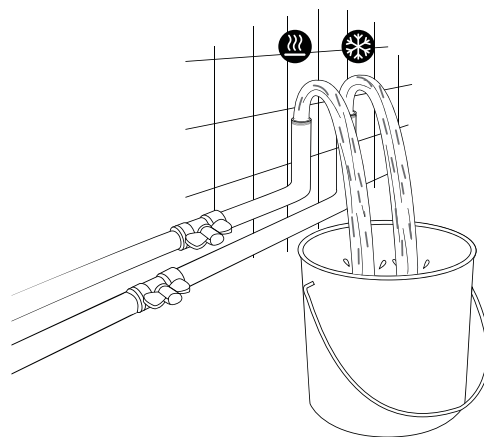

3

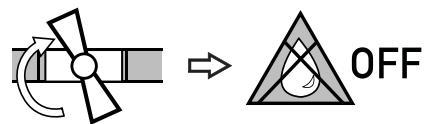



FR: Montage / ES: Montaje / PT: Montagem / IT: Montaggio / EL: Συναρμολόγηση /
PL: Montaż / RU: Сборка / KZ: Монтаждау / UA: Збірка / RO: Montaj / BR: Montagem /
EN: Assembly

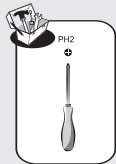
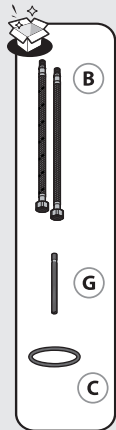

1

1

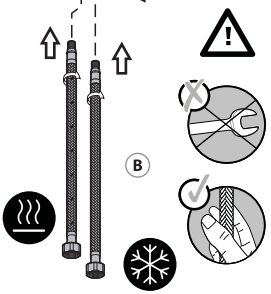
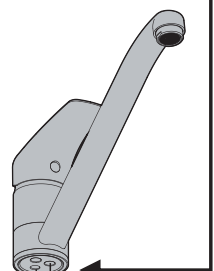
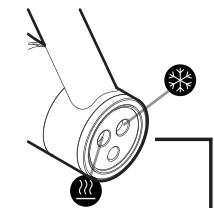

2

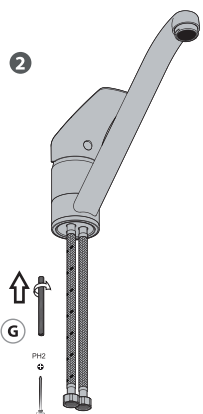

3

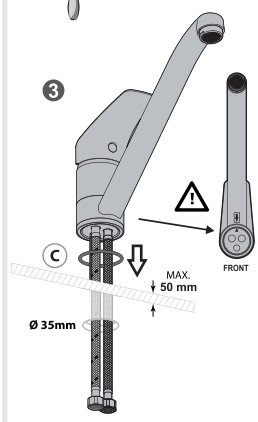

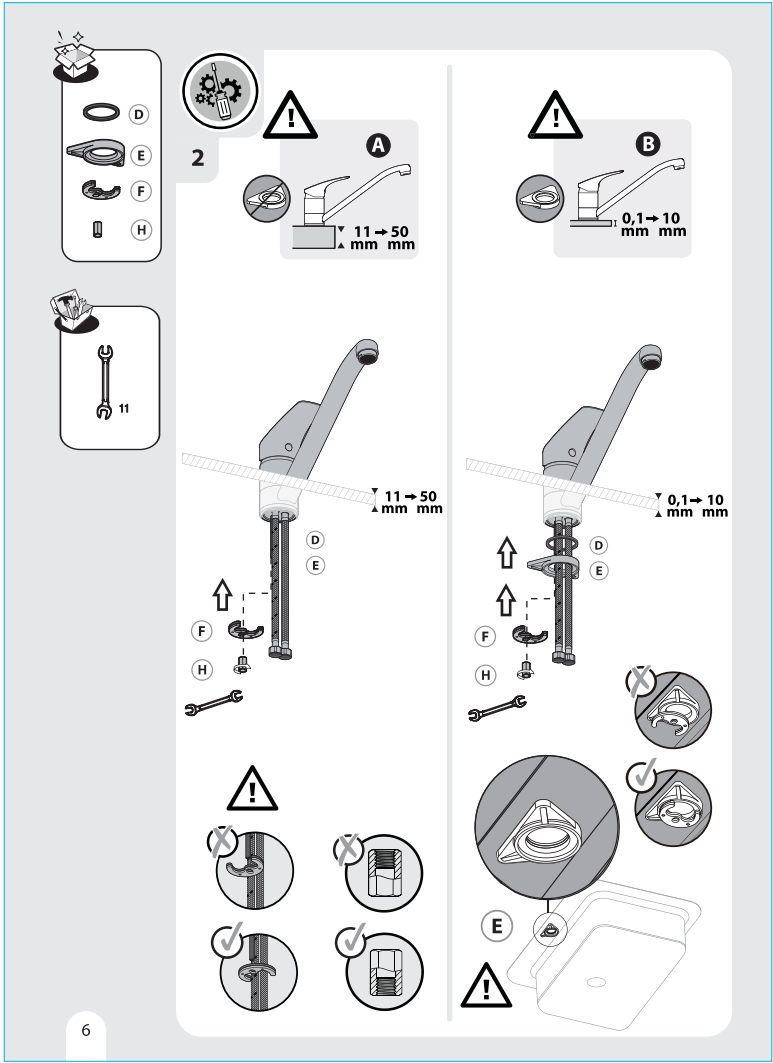

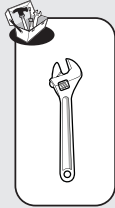

3

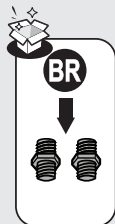
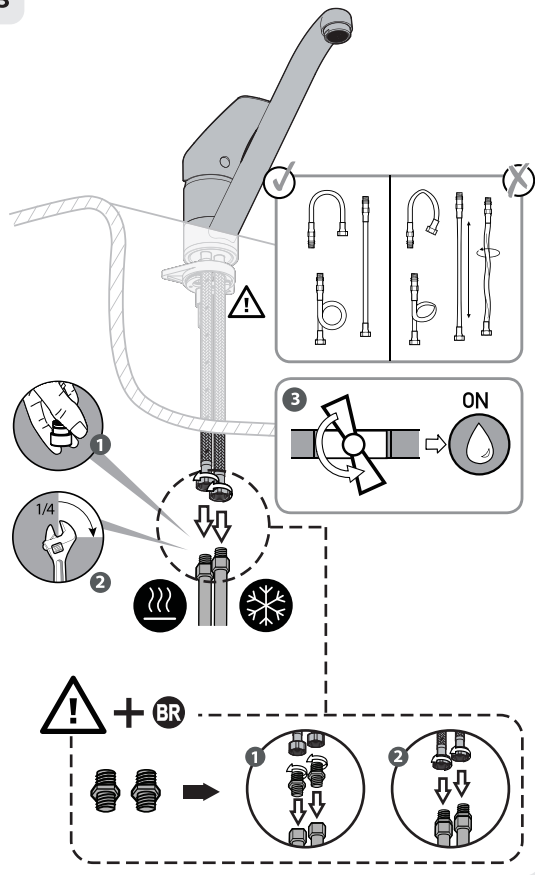

7



FR: Utilisation eau chaude-eau froide/ ES: Utilización agua caliente-agua fría/ PT: Utilização água quente-água fria/
IT: Uso acqua calda-acqua fredda/ EL: Χρήση ζεστής-κρύου νερού/ PL: Użytkowanie zimnej wody-gorącej wody/
RU: использование горячей и холодной воды/ KZ: Суық және ыстық суды қолдану/
UA: використання гарячої - холодної води/ RO: Utilizare apă caldă-apă rece/ BR: Uso de água quente e fria/
EN: Using hot and cold water

1

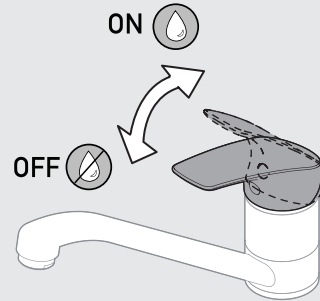
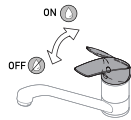

2

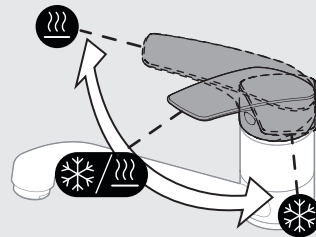



FR: Changement de cartouche/ ES: Cambio de cartucho/ IT: Cambio cartuccia/ PT: Mudança de cartucho/
EL: Αλλαγή φασγγίου/ PL: Wymiana wkładu/ RU: Смена картриджа/ KZ: Картриджа ауыстыру/
UA: Заміна картриджа/ RO: Schimbare cartus/ BR: Substituição de cartucho/ EN: Replacing the cartridge

1

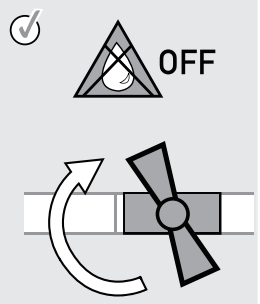

2

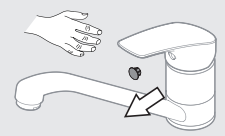

3

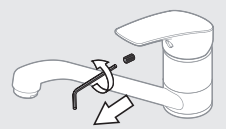

4

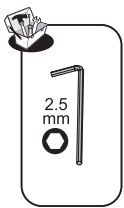
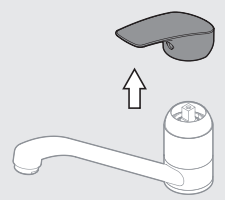

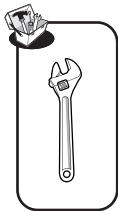

FR: Changement de cartouche/ ES: Cambio de cartucho/ IT: Cambio cartuccia/ PT: Mudança de cartucho/
EL: Αλλαγή φουσιγίου/ PL: Wymiana wkładu / RU: смена картриджа/ KZ: Картриджді ауыстыру/
UA: Заміна картриджа/ RO: Schimbare cartus/ BR: Substituição de cartucho/ EN: Replacing the cartridge

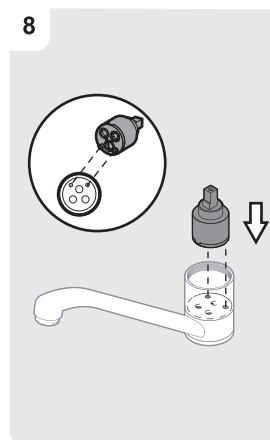
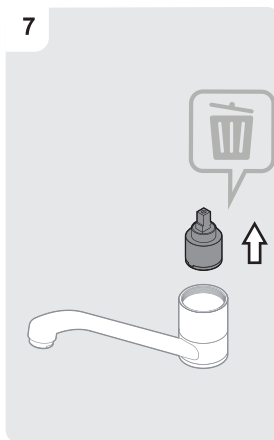

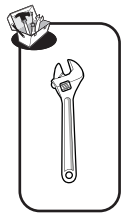

FR: Changement de cartouche/ ES: Cambio de cartucho/ IT: Cambio cartuccia/ PT: Mudança de cartucho/
EL: Αλλαγή φασγγίου/ PL: Wymiana wkładu / RU: Смена картриджа/ KZ: Картриджа ауыстыру/
UA: Заміна картриджа/ RO: Schimbare cartuş/ BR: Substituição de cartucho/ EN: Replacing the cartridge

9

10-12 N.m

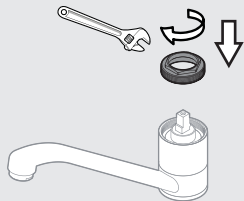

10

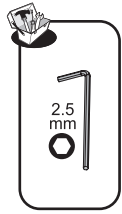
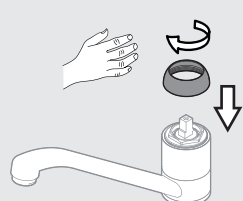

11

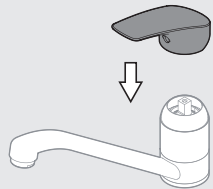

12





FR: Changement de cartouche/ ES: Cambio de cartucho/ IT: Cambio cartuccia/ PT: Mudança de cartucho/
EL: Αλλαγή φιοσιγγίου/ PL: Wymiana wkładu / RU: Смена картриджа/ KZ: Картриджді ауыстыру/
UA: Заміна картриджа/ RO: Schimbare cartus/ BR: Substituição de cartucho/ EN: Replacing the cartridge

13

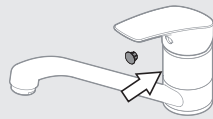

14

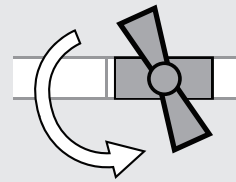

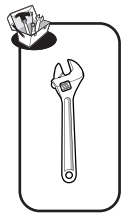

FR: Changement de mousseur/ ES: Cambio de aireador/ PT: Mudança de arejador/ IT: Cambio rompigetto/
 EL: Αλλαγή αεράτορα / PL: Wymiana perlatora / RU: Смена аэратора/ KZ: Ауақанықтығышты ауыстыру/
 UA: Заміна аератора/ RO: Schimbare aerator/ BR: Substituição do aerador/ EN: Replacing the aerator

1

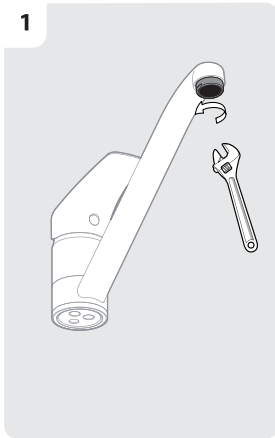

2



3

FR Vinaigre IT Aceto RU Уксус NO Østet
 ES Vinagre EL Ξίδιο KZ Сірке су NN Vinagre
 PL Winogre PL Ocet UA Оцет UN Vinegar

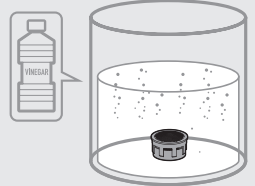

4

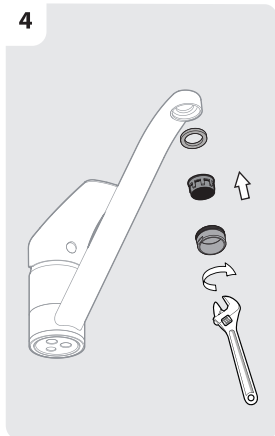

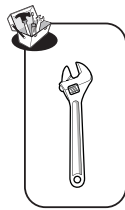

FR: Changement de flexibles/ ES: Cambio de flexibles/ PT: Mudança de flexíveis/ IT: Cambio flessibili/
EL: Αλλαγή λάστιχων/ PL: Wymiana wężyków instalacyjnych/ RU: Смена гибкого шланга для смесителя/
UA: Заміна гнучкого шланга для змішувача/ KZ: Қоспалауышқа арналған иілгіш шлангты ауыстыру/
RO: Schimbare furtune flexibile/ BR: Substituição das mangueiras/ EN: Replacing the hoses

1

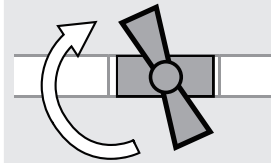

2

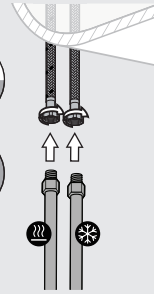

3

ON

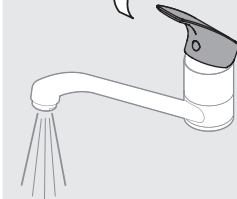

4

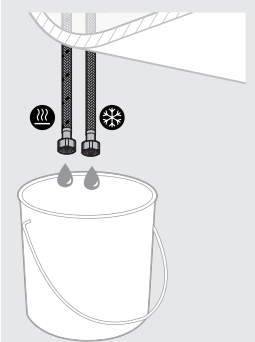

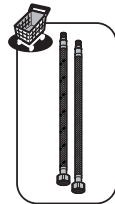
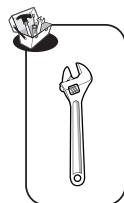

FR: Changement de flexibles/ ES: Cambio de flexibles/ PT: Mudança de flexíveis/ IT: Cambio flessibili/
EL: Αλλαγή λάστιχων/ PL: Wymiana wężyków instalacyjnych / RU: Смена гибкого шланга для смесителя/
UA: Заміна гнучкого шланга для змішувача/ KZ: Қоспалауышқа арналған иілгіш шлангты ауыстыру/
RO: Schimbare furtune flexibile/ BR: Substituição das mangueiras/ EN: Replacing the hoses

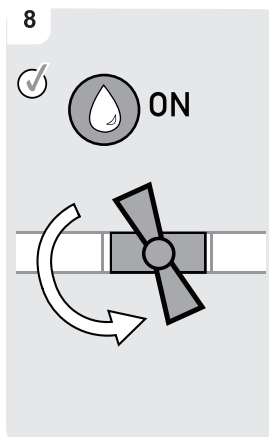
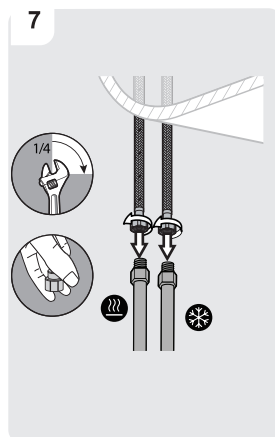
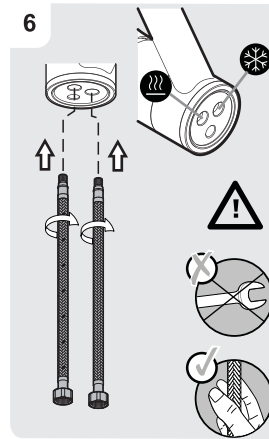
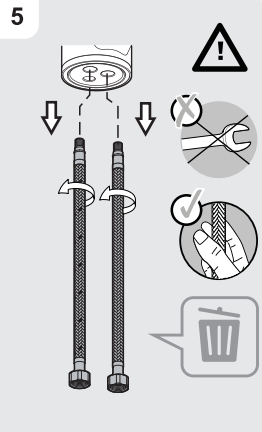



Eau claire / Agua limpia / Água limpa / Acqua pulita / Καθαρό νερό / Czysta woda / Чистая вода / Água limpa /
Чиста вода / Ara curata / таза су / Clean water



Sans solvant / Sin disolvente / Sem solventes / Senza solventi / Χωρίς διαλυτικά / Bez rozpuszczalnika / Без растворителя /
Sem solventes/ Без розчинника / Fara solvent / еріткішці/ Solvent-free

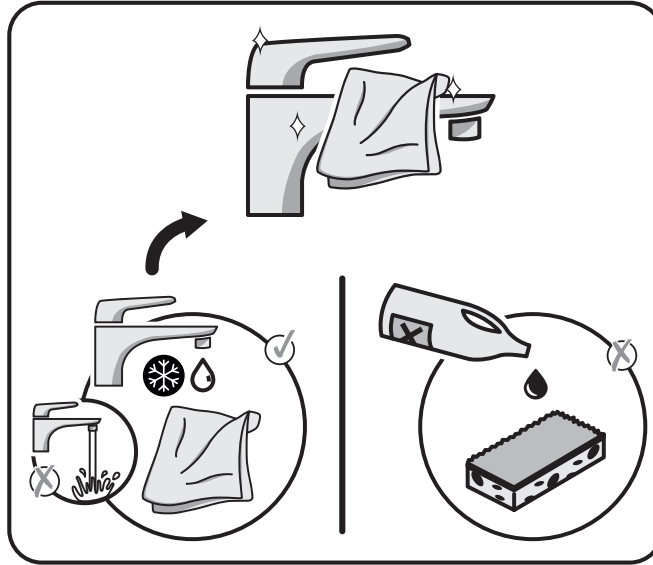

No.	Description	Code No.	QTY	Remark
1	Handle	SD2153	1	3276000592327 / 3276000632344 / 3276000597391
		SD2153-M		3276000596257 / 3276000597407
		SD2153-PB		3276000592358 / 3276000597414
		SD2153-FS		3276000592419
2	Beauty Cover	ZS42-003	1	3276000592327 / 3276000632344 / 3276000597391
		ZS42-003-M		3276000596257 / 3276000597407
		ZS42-003-FB		3276000592358 / 3276000597414
3	Pressing Nut	SD90041-01-2P	1	3276000592419
		SD90041-01-2P		
4	Cartridge	SN-40 S/D THE DRA	1	
		SD90045-7C-01		3276000592327 / 3276000632344 / 3276000597391
5	Mixer Body	SD90045-7C-M-01	1	3276000596257 / 3276000597407
		SD90045-7C-PB-01		3276000592358 / 3276000597414
		SD90045-7C-FS-01		3276000592419
		SD90045-7C-FS-01		
6	O-ring	Ø46X3	1	
7	Triangle base	SD60045C-2-02A	1	
8	Fltng set	SD90015-00-06A	1	
9	Aerator	40.2104.000	1	
10	Aerator shell	SD3101-2400-03	1	
11	Inlet hose	TAG-FEX-DNE-ACB H3/8-MBX1 L12-450	2	3276000592327 / 3276000592419
		TAG-FEX-DNE-ACB H1/2-MBX1 L12-450		3276000632344 / 3276000597391 3276000597407 / 3276000597414
12	Joint	SD606-012S	2	

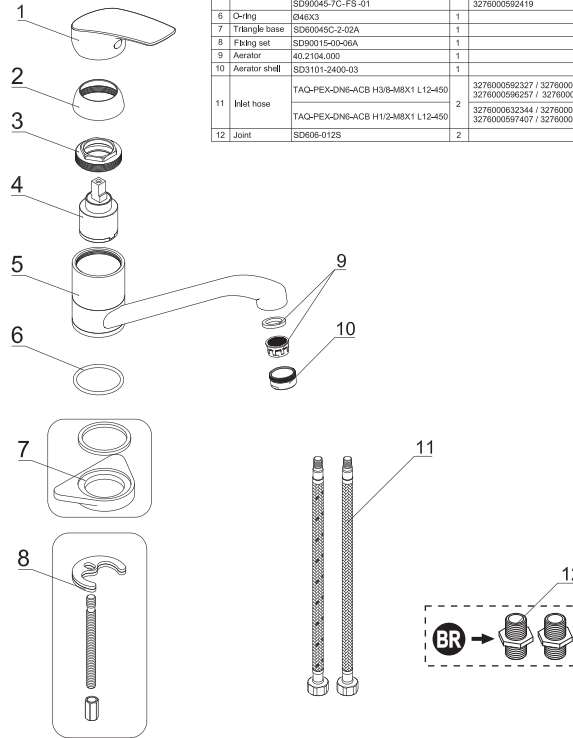







Certificado de conformidad sanitaria.
Atestado de conformidade sanitária.
certificato di conformità sanitaria.
Βεβαίωση υγειονομικής συμόρφωσης.
Certyfikat zgodności sanitarnej.
Декларация о соответствии санитарным нормам
Санитарлық талаптарға сәйкестік декларациясы
Декларация про відповідність санітарним нормам
Atestat de conformitate sanitară
Certificado de conformidade sanitária.
Declaration of sanitary conformity.
Attestation de conformité sanitaire



* Garantie 10 ans / 10 años de garantía / Garanzia de 10 anos / Garanzia 10 Anni / Εγγύηση 10 ετών / Gwarancja 10-letnia / Гарантія 10 років / Keniligiik 10 жыл / Гарантія 10 років / Garantie 10 anni / 10 años de garantía / 10-year guarantee

Made in P.R.C. 2022

ADEO Services - 135 Rue Sadi Carnot - CS 00001
59790 RONCHIN - France

UA ТОВ «Ілєра Мерлен Україна»,
вул. Поліарна 17а, м. Київ 04201, Україна

