

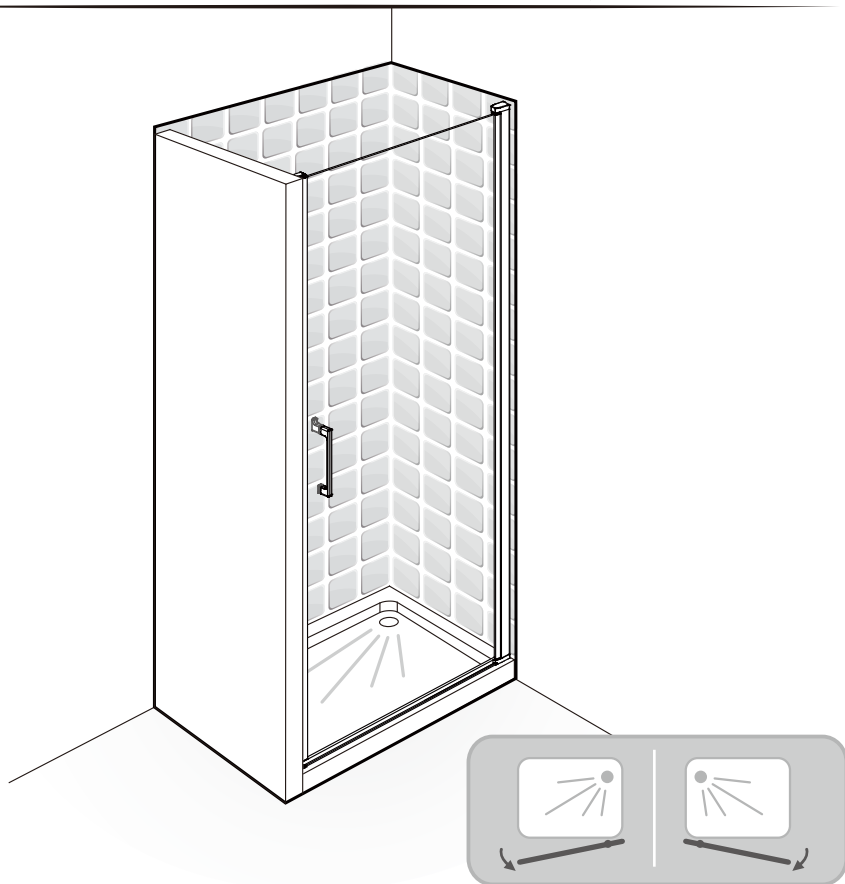

10
YEARS
Guarantee

REMIX



EAN CODE :

3276000692935 3276000692911 3276000692928
3276000693277 3276000693253 3276000693260
3276000692904 3276000693284 3276000692898



FR Notice de Montage -
Utilisation - Entretien

ES Instrucciones de Montaje,
Utilización y Mantenimiento

PT Instruções de Montagem,
Utilização e Manutenção

IT Istruzioni per il Montaggio,
l'Uso e la Manutenzione

EL Εγχειρίδιο συναρμολόγησης,
χρήσης και συντήρησης

PL Instrukcja Montażu,
Użytkowania i Konserwacji

RU Руководство По Сборке
и Эксплуатации

KZ Жинау, пайдалану және
техникалық қызмет
көрсету нұсқаулығы

UA Керівництво По Збірці
і Експлуатації

RO Manual asamblare,
utilizare și întreținere

EN Assembly - Use -
Maintenance Manual



- FR** Nous vous remercions d'avoir acheté ce produit. Nous vous conseillons de lire attentivement la notice d'installation, d'utilisation et d'entretien. Nous avons conçu ce produit pour vous apporter entière satisfaction.
Si vous avez besoin d'aide l'équipe de votre magasin est à votre disposition pour vous accompagner.
- ES** Le agradecemos haber comprado este producto. Le recomendamos leer atentamente el manual de instalación, uso y mantenimiento. Este producto ha sido diseñado para proporcionarle plena satisfacción.
Si necesita alguna ayuda, el personal de la tienda estará a su disposición para guiarle.
- PT** Agradecemos a sua preferência por este produto. Aconselhamo-lo a ler o manual de instalação, utilização e manutenção com atenção. Criámos este produto para sua completa satisfação.
Se precisar de ajuda, a equipa da sua loja está à sua disposição para o acompanhar.
- IT** Grazie per aver acquistato questo prodotto. Vi raccomandiamo di leggere attentamente il manuale di installazione, utilizzo e manutenzione. Questo prodotto è stato progettato per offrirvi la massima soddisfazione.
Per ricevere assistenza, il personale del punto vendita è a vostra disposizione.
- EL** Ευχαριστούμε για την αγορά σας αυτού του προϊόντος. Σας συμβουλεύουμε να διαβάσετε προσεκτικά τις οδηγίες εγκατάστασης, χρήσης και συντήρησης. Σχεδιάσαμε αυτό το προϊόν για να σας προσφέρει πλήρη ικανοποίηση.
Αν χρειάζεστε βοήθεια, η ομάδα του καταστήματος από το οποίο αγοράσατε το προϊόν είναι στη διάθεσή σας
- PL** Dziękujemy za zakup produktu firmy. Zalecamy, aby uważnie przeczytać instrukcję instalacji, użytkowania i konserwacji. Ten produkt marki zaprojektowaliśmy, aby spełnić wszystkie Państwa oczekiwania.
W razie potrzeby pracownicy sklepu służą Państwu pomocą i są do Państwa dyspozycji.
- RU** Благодарим Вас за приобретение изделия. Рекомендуем внимательно прочитать инструкции по установке, эксплуатации и техническому обслуживанию. Изделие разработано, чтобы доставить Вам удовольствие.
Если Вам потребуется помощь, консультанты Вашего магазина находятся в Вашем распоряжении.
- KZ** Өнімін сатып алғаныңыз үшін алғыс білдіреміз. Орнату, қолдану және қызмет көрсету жөніндегі нұсқаулықтарды мұқият оқып шығуға кеңес береміз. Біз бұл өнімін сізді толықтай қанағаттаныру үшін жасап шығардық.
Егер сізге көмек қажет болса сіздің бөлшектен сататын дүкеніңіздегі топ сізге жәрдем береді.
- UA** Дякуємо вам за покупку цього виробу. Ми радимо вам уважно прочитати інструкції з установлення, експлуатації та технічного обслуговування. Ми розробили цей виріб для того, щоб він приносив вам задоволення.
Якщо вам потрібна допомога, співробітники вашого магазину готові допомогти вам
- RO** Vă mulțumim pentru achiziționarea acestui produs. Vă sfătuim să citiți cu atenție instrucțiunile de instalare, de utilizare și de întreținere. Am conceput acest produs pentru a vă furniza satisfacție totală.
Dacă aveți nevoie de ajutor, echipa magazinului de cumpărare este la dispoziția dumneavoastră pentru a vă asista.
- EN** Thank you for purchasing this product. We recommend that you read the installation, user and maintenance instructions carefully. We have designed this product to ensure your complete satisfaction.
If you require assistance, the team at your retailer is on hand to help you.

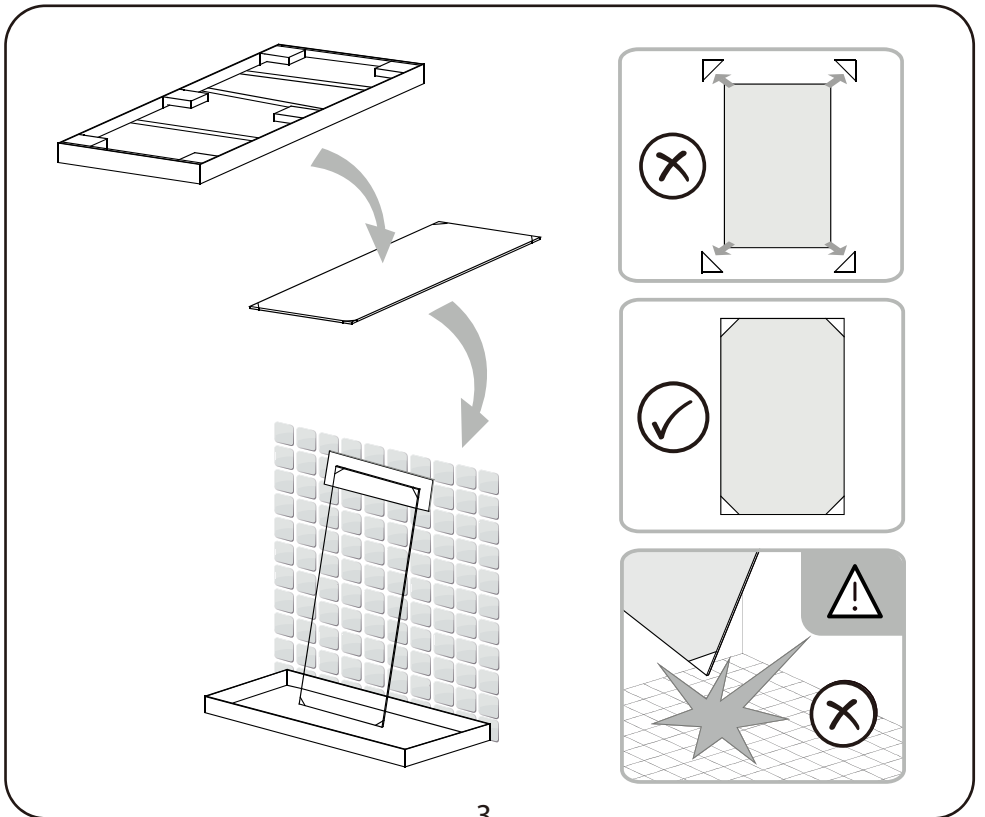

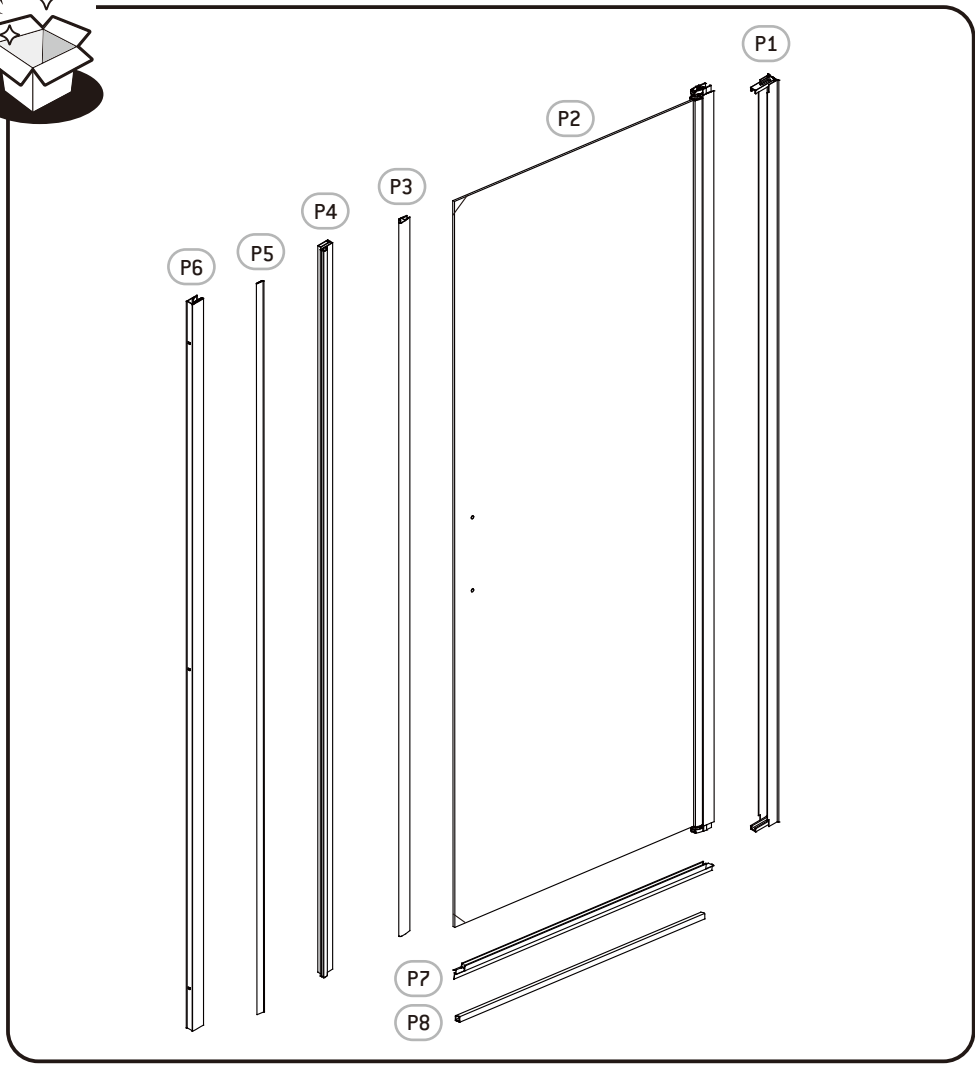

H19 x1	H21 x1	H24 x1 3mm	H85 x1	H86 x1	H87 x1
H1 x6	H2 x6 ST 4x45mm	H4 x1	H8 x1	H9 x1	
H88 x1					



0 1 2 3 4 5 cm

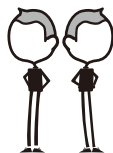

H1
x6

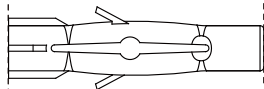

H2
x6

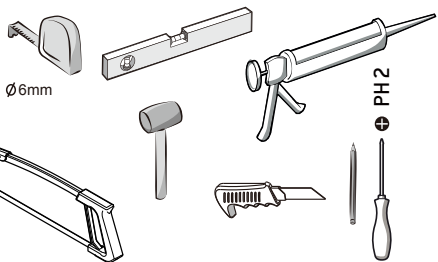
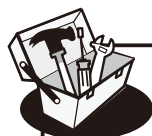
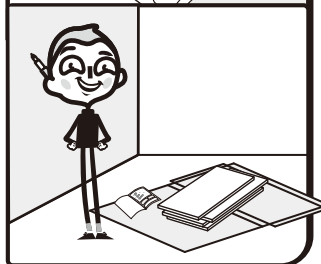
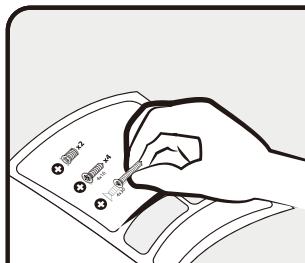
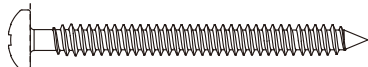



3M

Assemble with this side, with easy clean treatment, on the inside.

İze karşı işleme tabi tutulmuş bu yüz iç tarafa doğru konulmalıdır.

Cette face, avec un traitement facilement nettoiyable, doit être positionnée vers l'intérieur

Esta cara está tratada para facilitar su limpieza y se debe colocar hacia el interior

Esta face com tratamento para facilitar a limpeza, deve ficar voltada para o interior

Questo lato, deve essere posizionato con il trattamento easy clean all'interno.

Эта сторона, обработанная средством против образования накипи, должна быть обращена вовнутрь.

Страна, обрблена засобом проти накипу, повинна бути звернена всередину.

Această față, tratată pentru curățare ușoară, trebuie poziționată spre interior

Strona z powłoką zapewniającą łatwe czyszczenie powinna być skierowana do wewnątrz.

Αυτή η όψη, με επεξεργασία για εύκολο καθαρισμό, πρέπει να τοποθετηθεί προς το εσωτερικό.

V.7 2014

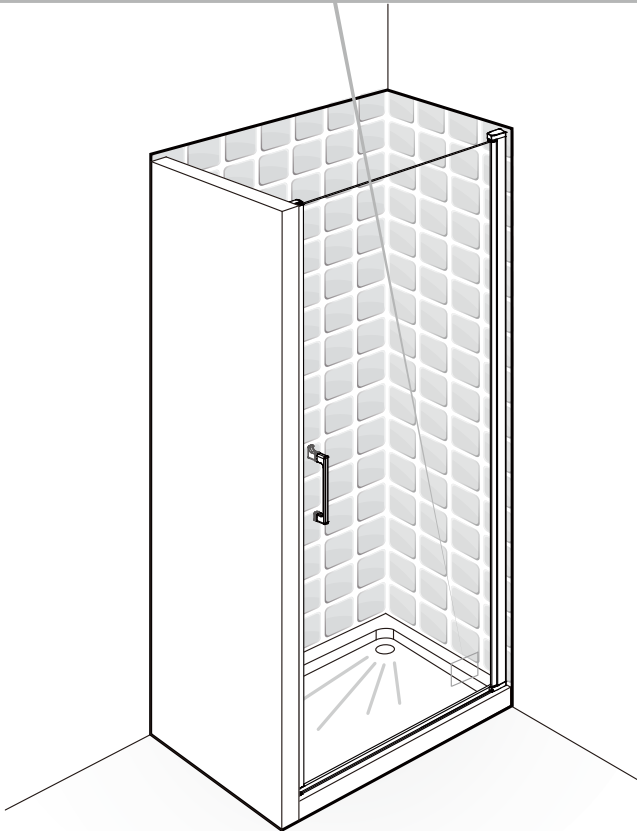



FR: Préparation / **ES:** Preparación / **PT:** Preparação / **IT:** Preparazione / **EL:** Προετοιμασία /
PL: Przygotowanie / **RU:** Подготовка / **KZ:** Дайындау / **UA:** Підготування / **RO:** Pregătire /
EN: Preparation

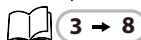

FR: Montage / **ES:** Montaje / **PT:** Montagem / **IT:** Montaggio / **EL:** Συναρμολόγηση /
PL: Montaż / **RU:** Сборка / **KZ:** Монтаждау / **UA:** Збірка / **RO:** Montaj / **EN:** Assembly



FR: Entretien / **ES:** Mantenimiento / **PT:** Manutenção / **IT:** Manutenzione / **EL:** Συντήρηση /
PL: Konserwacja / **RU:** Уход / **KZ:** Және техникалық қызмет көрсету / **UA:** Догляд / **RO:** Întreținere /
EN: Maintenance



FR: Mentions Légales & Consignes de Sécurité / **ES:** Instrucciones Legales y de Seguridad /
PT: Avisos Legais e instruções de Segurança / **IT:** Istruzioni Legali e di Sicurezza /
EL: Νομικό σημείωμα και οδηγίες ασφαλείας / **PL:** Uwagi Prawne i Instrukcja Bezpieczeństwa /
RU: Руководство по технике безопасности и правовым нормам /
KZ: Қауіпсіздік және құқықтық басшылық / **UA:** Керівництво з Техніки /
RO: Manual privind siguranța / **EN:** Legal & Safety Instructions





- I**
- FR** Vérifiez que les chevilles murales fournies sont appropriées à votre mur (celles fournies dans l'emballage sont conçues pour le béton). Sinon, utilisez des vis et des chevilles murales adaptées au type de matériau de votre mur. Pour obtenir des conseils concernant les vis et les chevilles appropriées à votre mur, demandez à un vendeur spécialisé.
- ES** Compruebe que todos los tacos suministrados puedan ser utilizados con su pared (los incluidos en la caja son para hormigón). En caso contrario, utilice tornillos y tacos de pared apropiados para el material de su pared. Para información acerca de las fijaciones y tornillos apropiados para su pared, consulte con un asistente de ventas especializado.
- PT** Certifique-se de que as buchas fornecidas são adequadas à sua parede (as fornecidas na embalagem são para betão). Caso contrário, use parafusos e buchas adequados ao tipo de material da sua parede. Para se aconselhar acerca dos parafusos e buchas adequados à sua parede, fale com um assistente de vendas especializado.
- IT** Verificare che i tasselli da parete forniti siano compatibili con la propria parete (quelli forniti con l'articolo sono per cemento). Altrimenti, utilizzare viti e tasselli adatti per la superficie della propria parete. Per ottenere consigli e suggerimenti sulle viti e i tasselli più adatti alla propria parete, consultare un rivenditore specializzato.
- EL** Βεβαιώθετε ότι οι παρεχόμενες στερεώσεις τοίχου είναι κατάλληλες για τον τοίχο σας (οι παρεχόμενες στη συσκευή προορίζονται για μπετό). Αλλιώς χρησιμοποιήστε βίδες και στερεώσεις τοίχου κατάλληλες για τον τύπο υλικού του τοίχου σας. Για να λάβετε συμβουλές σχετικά με τις κατάλληλες βίδες και τα εξαρτήματα για τον τοίχο σας, ρωτήστε έναν ειδικό πωλητή.
- PL** Prosimy sprawdzić, czy dostarczone kołki do ścian nadają się do użycia w posiadanej ścianie (kołki dostarczone w zestawie są przeznaczone do betonu). Jeśli tak nie jest, należy użyć śrub i kołków odpowiednich do materiału, z którego wykonana jest ściana. Aby uzyskać poradę w sprawie śrub i elementów montażowych odpowiednich do danego typu ściany, należy zwrócić się z pytaniem do wyspecjalizowanego sprzedawcy.
- RU** Убедитесь, что прилагаемые дюбеля подходят для ваших стен (входящие в комплект дюбеля предназначены для бетона). В противном случае используйте шурупы и дюбеля, соответствующие материалу стены. Для получения рекомендаций по выбору шурупов и крепежных деталей, подходящих для вашей стены, обратитесь к специалисту-консультанту.
- KZ** Жеткізілетін қабырға анкерінің (қаланған тастарды ұстастыратын темір) сіздің қабырғаңызға үйлесімділігін тексеріңіз (жиынтыққа кіретіні бетонға арналған). Олай болмаған жағдайда, қабырғаңыздың материалының түріне сәйкес бұрмашегелер мен қабырға анкерін пайдаланыңыз. Қабырғаңызға сәйкес бұрмашегелер мен бөлшектер туралы ақпарат алу үшін сату бөлімінің кеңесшісіне хабарласыңыз.
- UA** Перевірте, що анкери підходять для вашої стіни (ті, що постачаються в упаковці – для бетону). В іншому випадку використовуйте гвинти й стінові анкери, що відповідають матеріалу вашої стіни. Для отримання консультацій щодо гвинтів й фітінгів для вашої стіни зверніться до відповідного продавця-консультанта.
- RO** Verificați ca toate ancorele de perete furnizate să fie adecvate pentru perețele dumneavoastră (cele furnizate în pachet sunt pentru beton). În caz contrar, folosiți șuruburi și ancore de perete adecvate pentru tipul de material din care este perețele dumneavoastră. Pentru a obține recomandări privind șuruburile și armăturile adecvate pentru perețele dumneavoastră, întrebați un vânzător specializat.
- EN** Check that wall anchors provided are suitable for your wall (those provided in the package are for concrete). Otherwise, use screws and wall anchors suited to the type of material of your wall. To obtain advice on the screws and fittings suited to your wall, ask a specialized sales assistant.

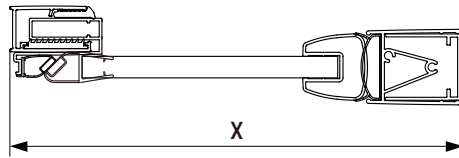

REMIX	X(mm)
800mm	775 - 805
900mm	875 - 905
1000mm	975 - 1005

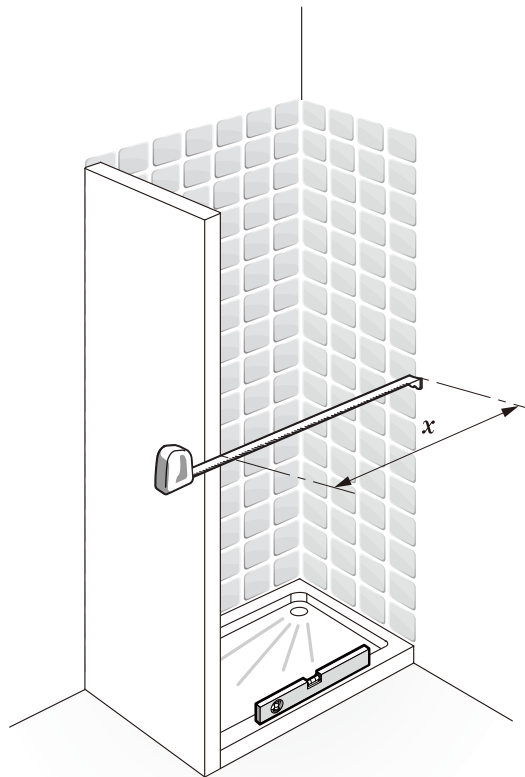

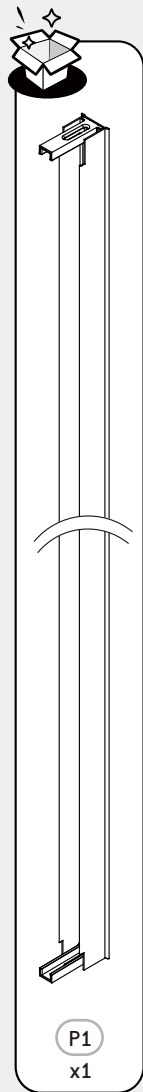

P1
x1

1

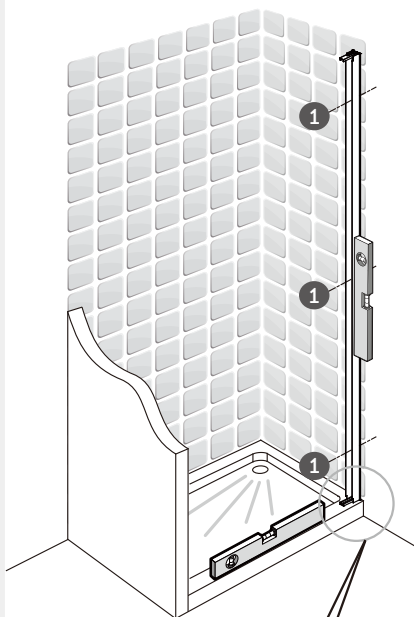
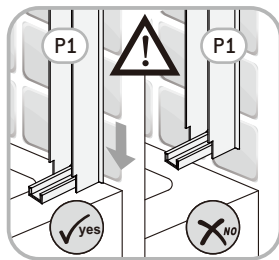
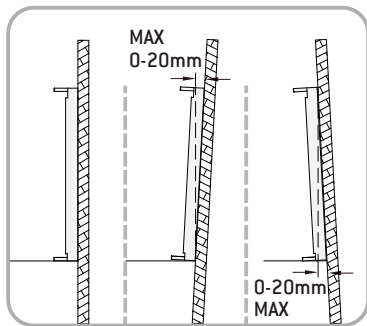

10mm minimum
10mm mínimo
10mm mínimo
10mm mínimo
10mm ελάχιστο
10mm minimalny
10mm минимальный
10mm минимум
10mm мінімальний
10mm minim
10mm minimum

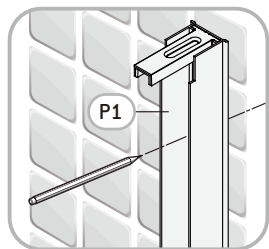
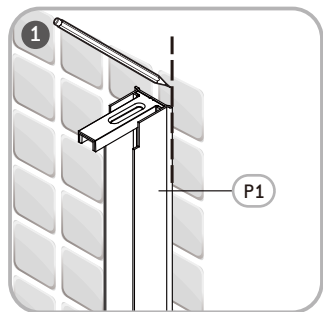
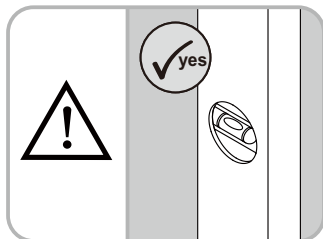
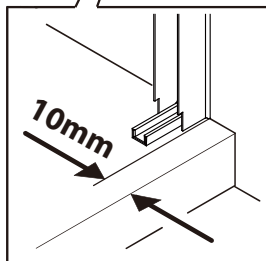



H1
x3



H2
x3

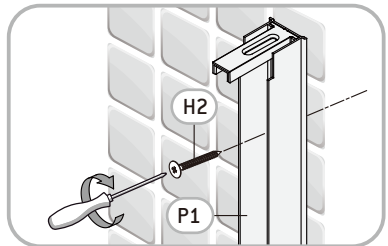
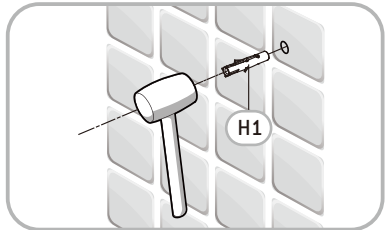
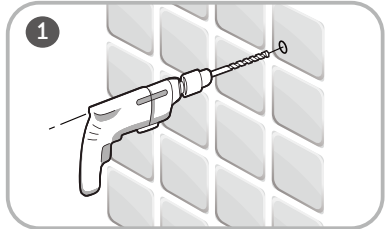
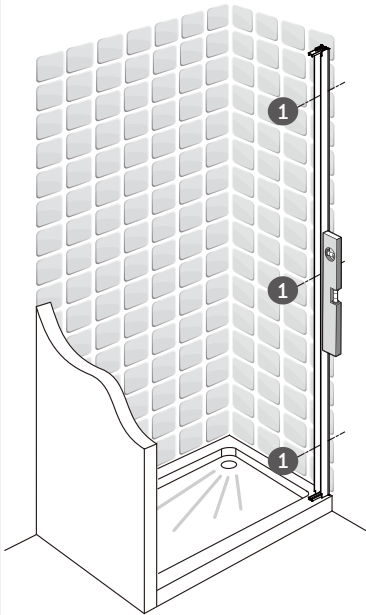
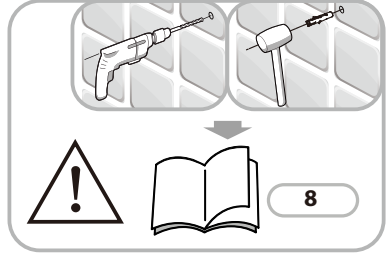
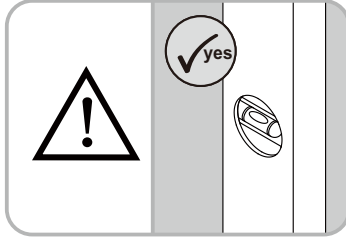



3

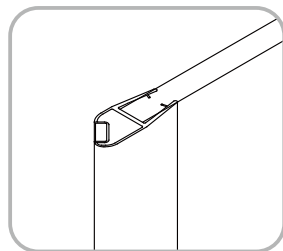
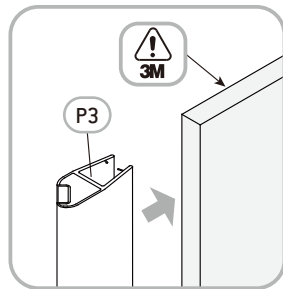
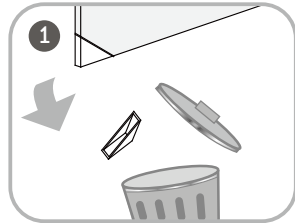
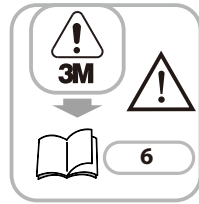
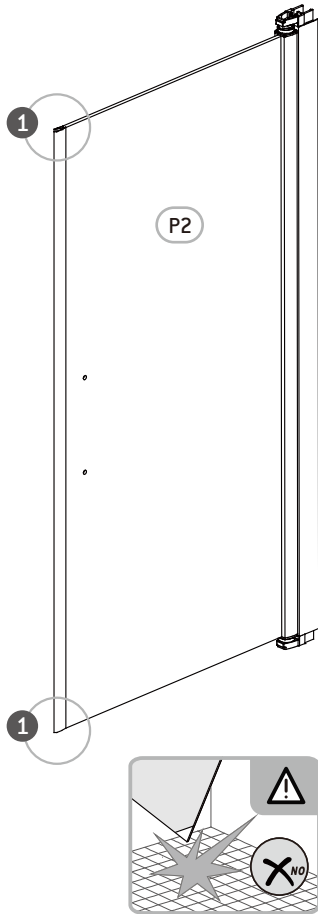
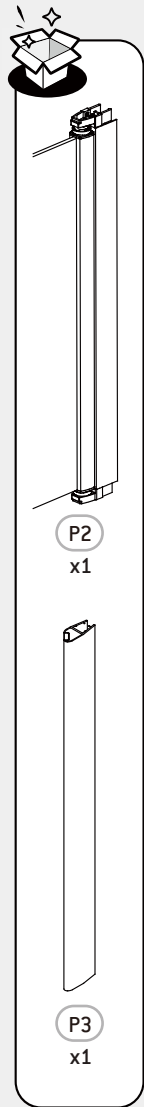



4

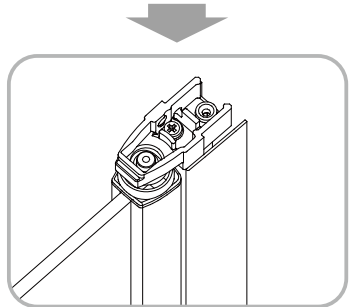
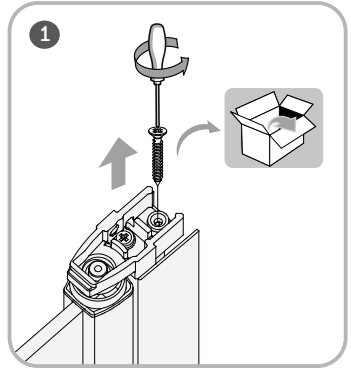
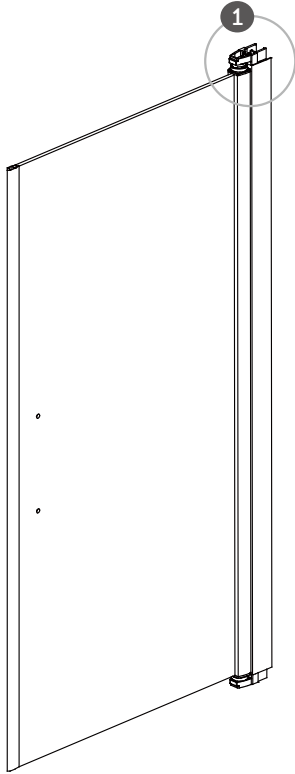

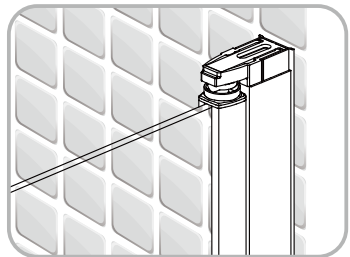
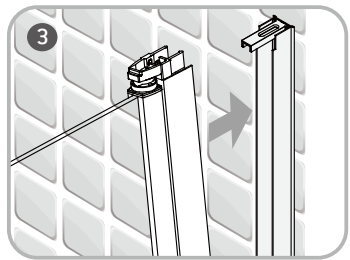
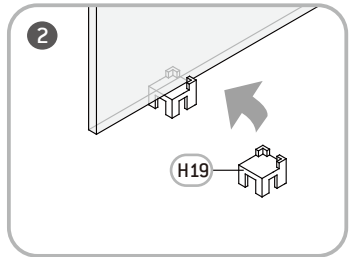
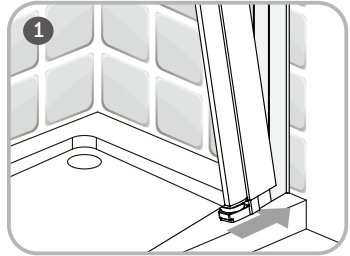
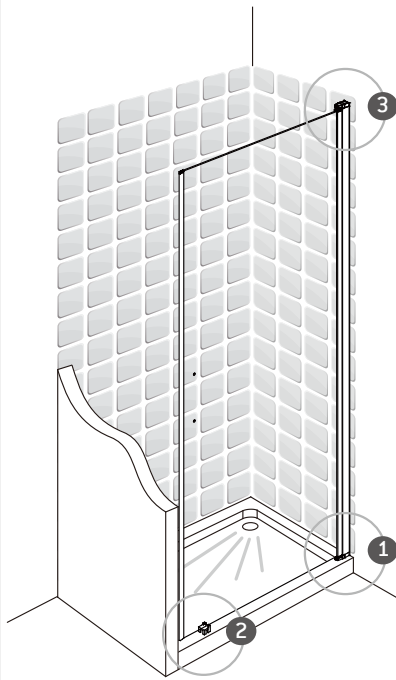
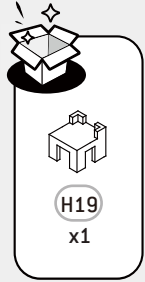



6

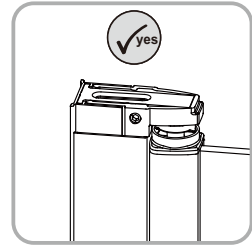
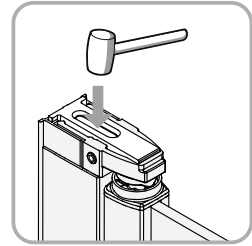
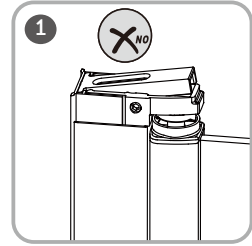
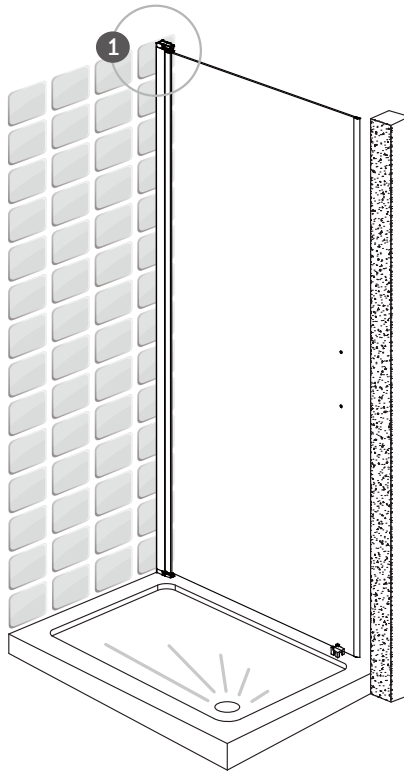



7

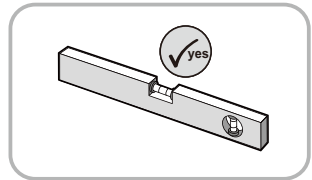
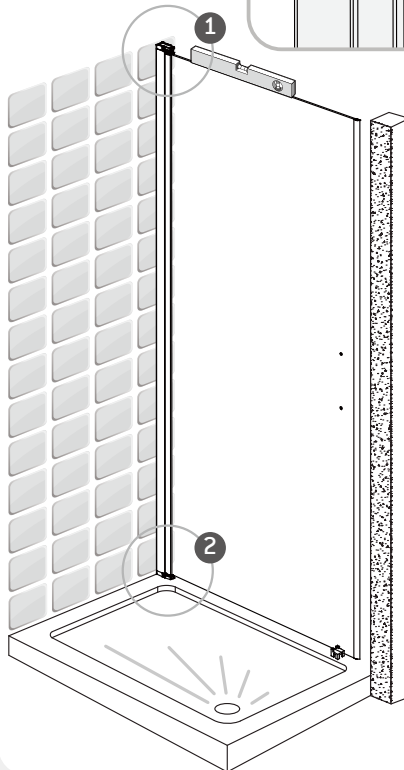
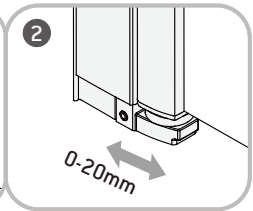
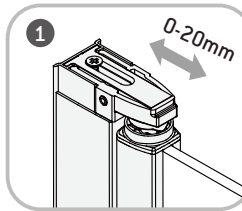
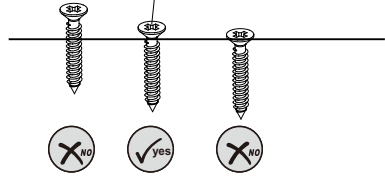
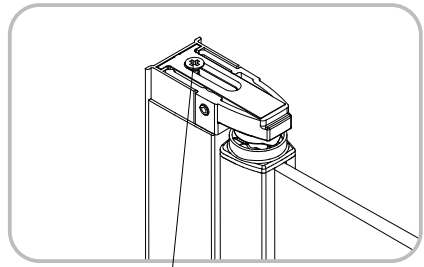
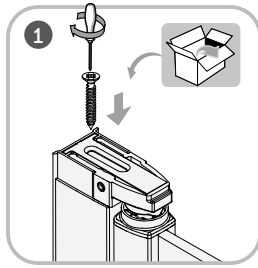

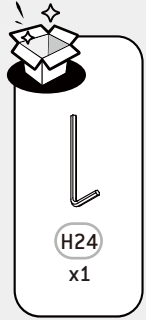

8

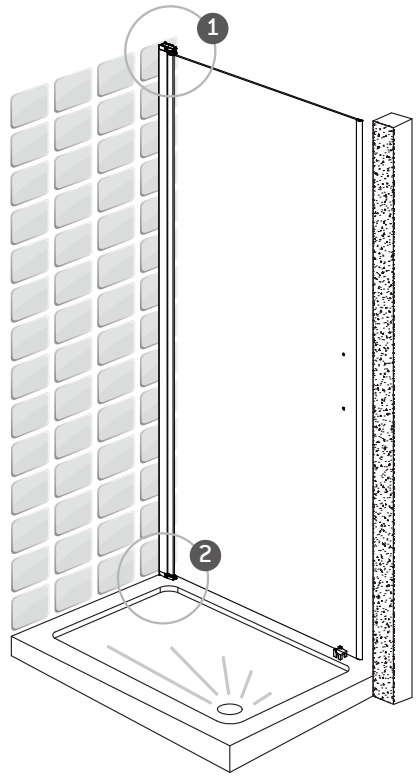
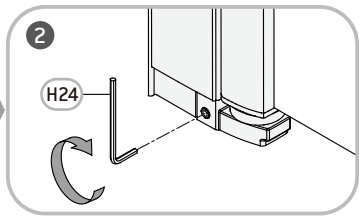
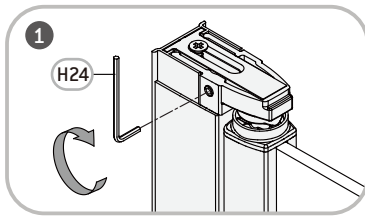
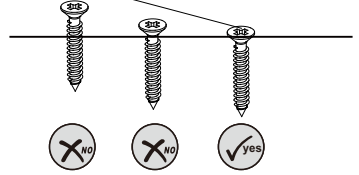
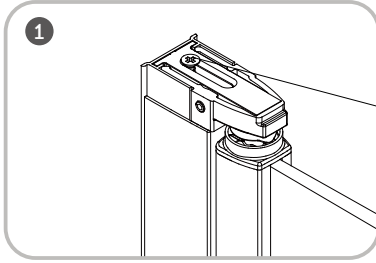



9



P4
x1



P6
x1

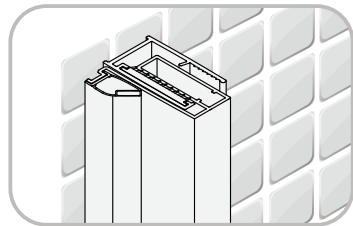
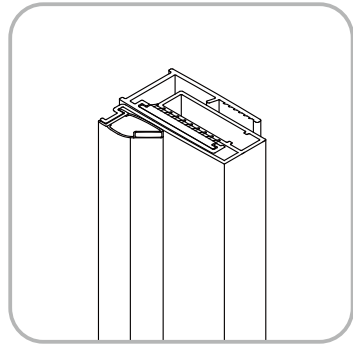
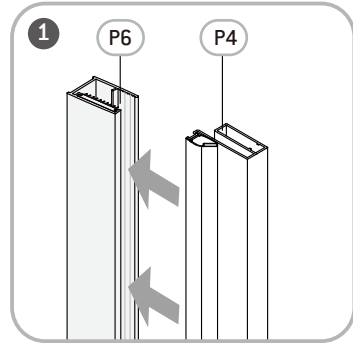
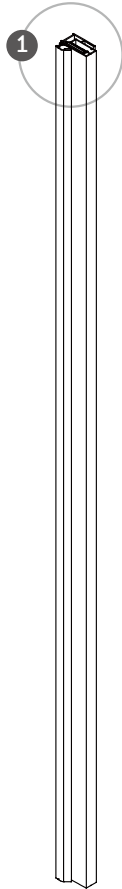



10

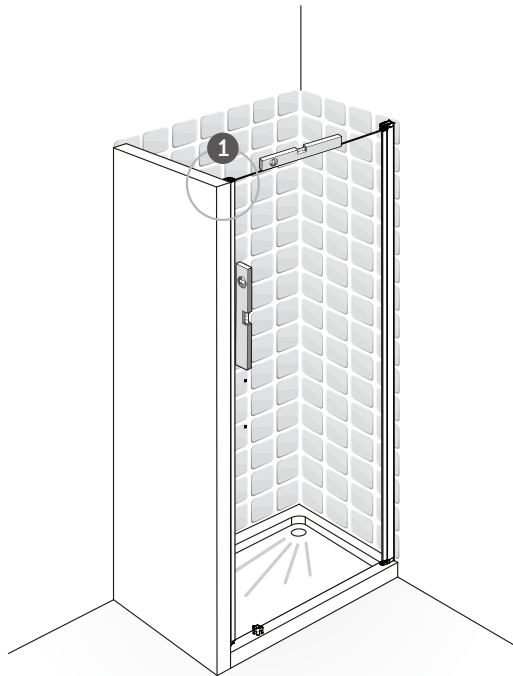
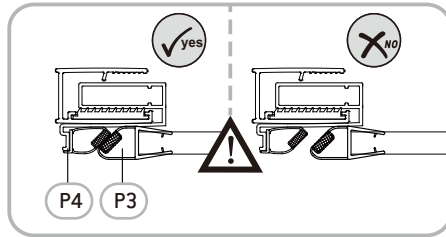
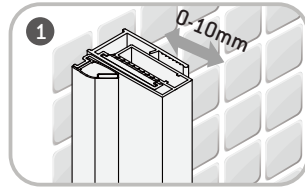



11

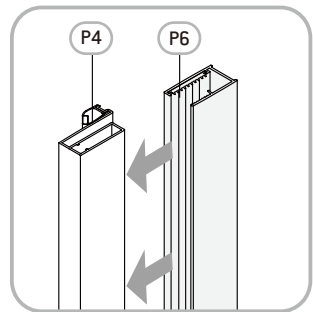
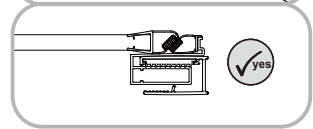
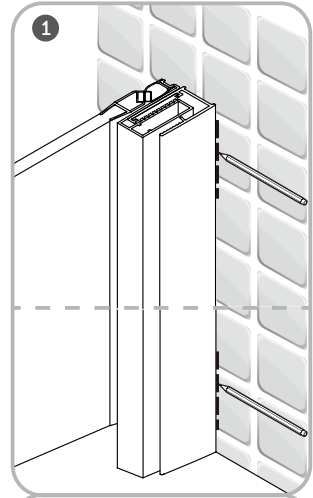
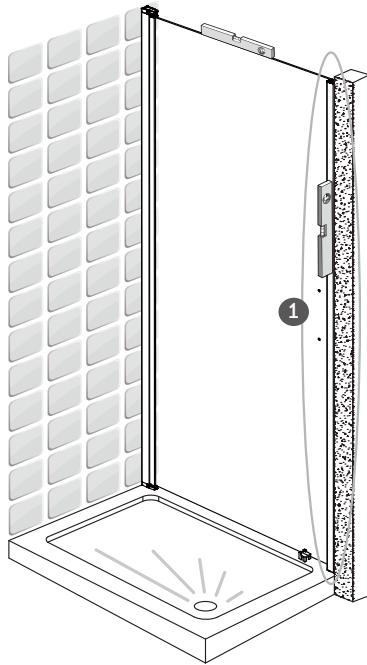

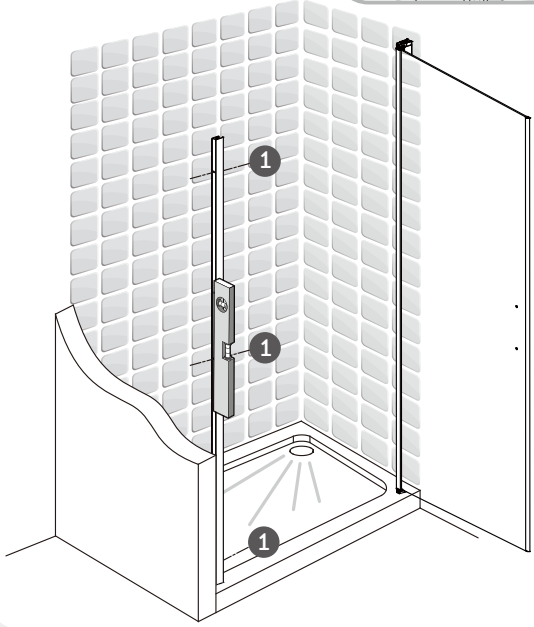
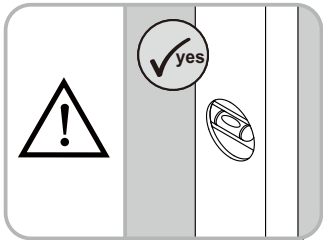
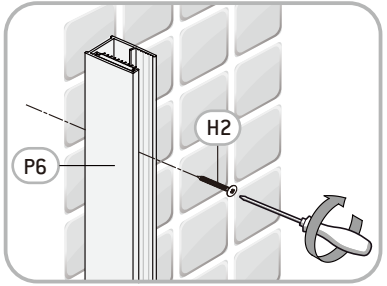
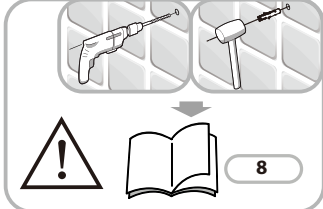
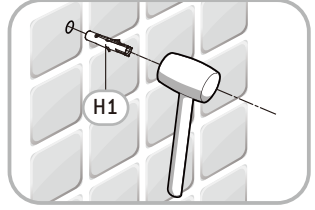
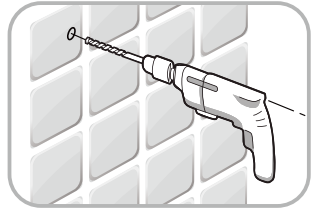
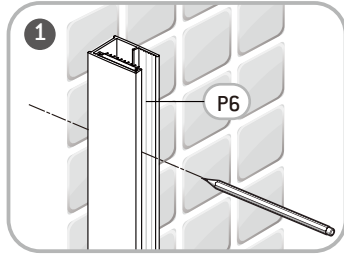
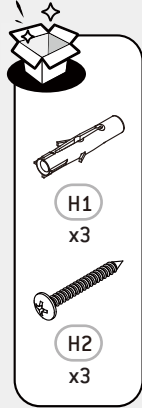

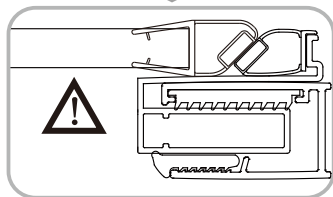
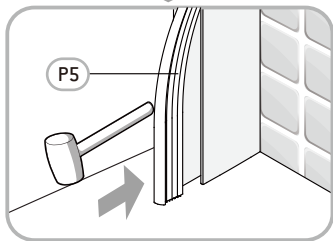
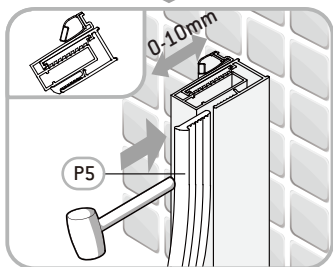
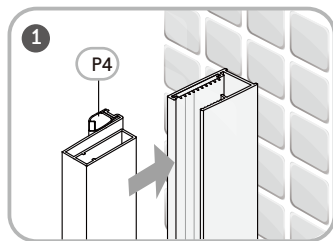
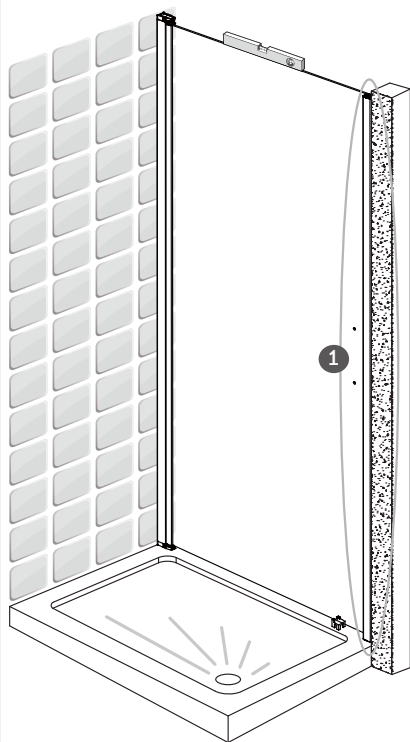



14

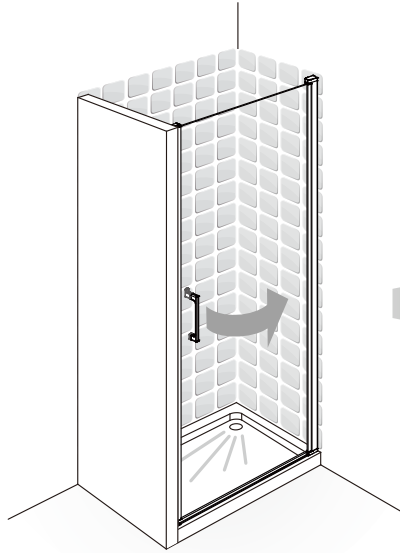

24→26

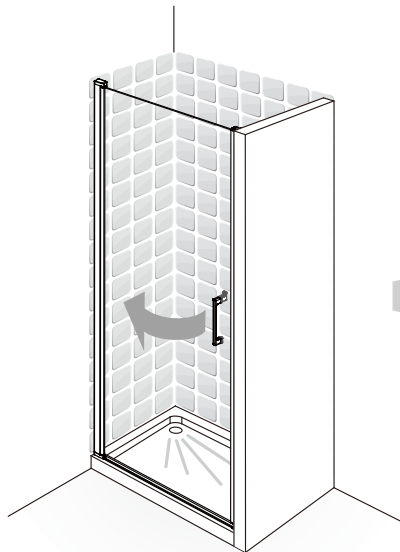

27→29

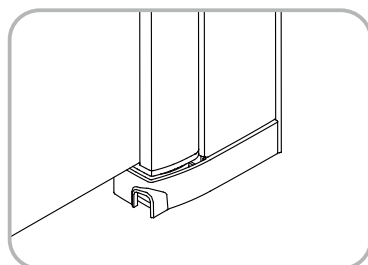
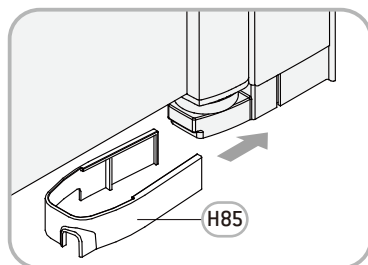
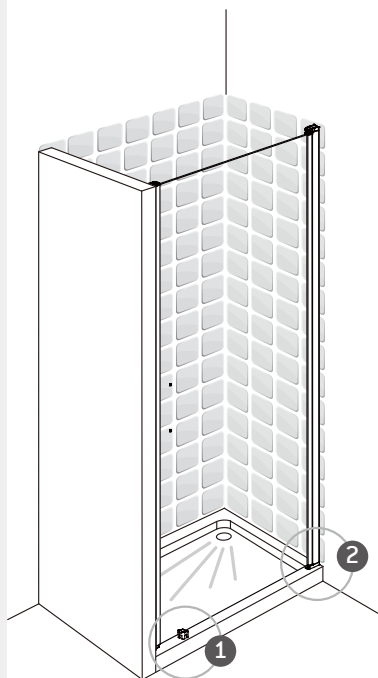
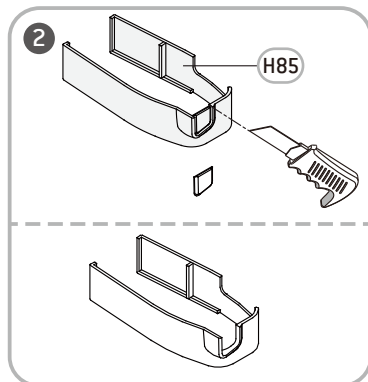
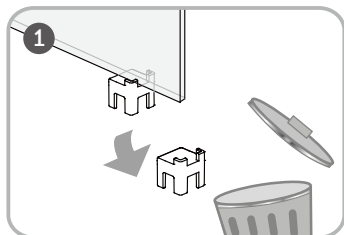
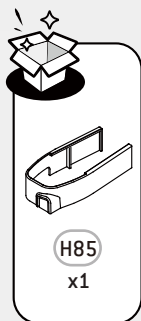

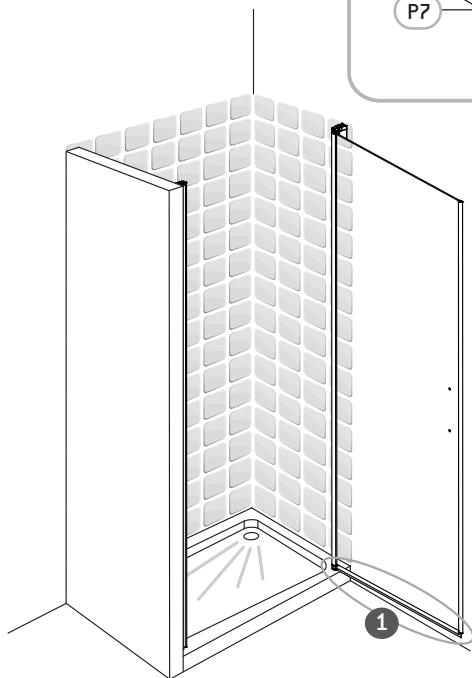
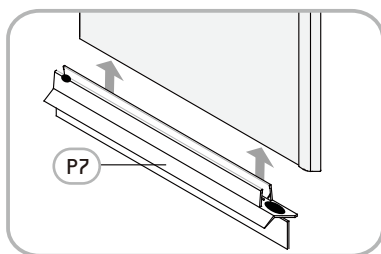
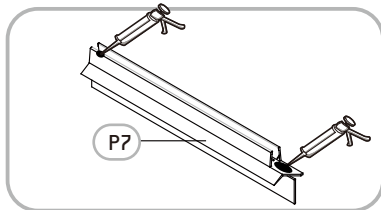
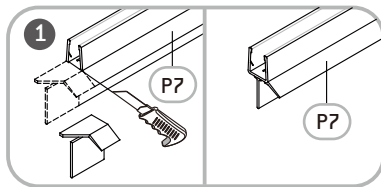
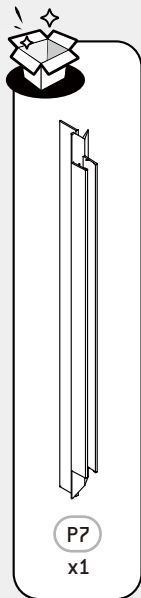



P8
x1



H87
x1

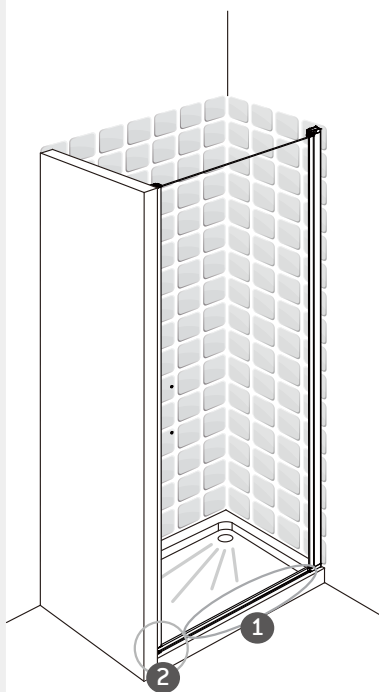
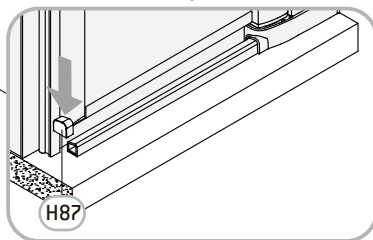
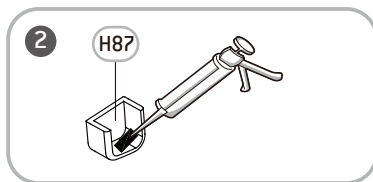
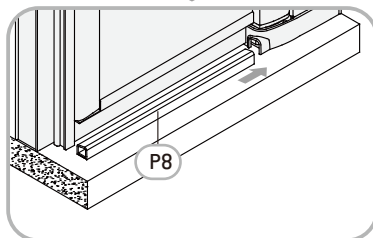
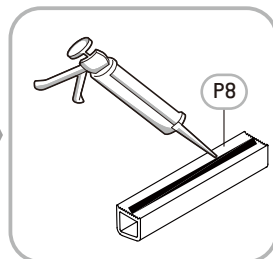
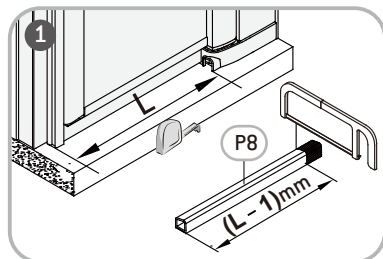

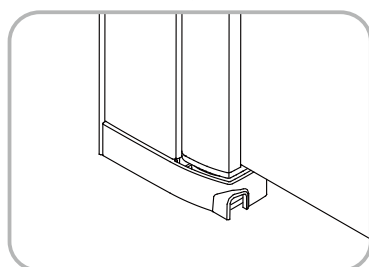
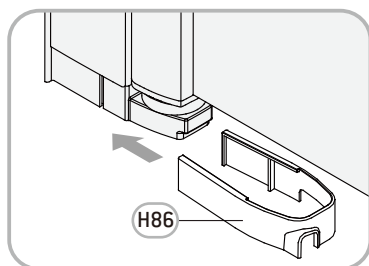
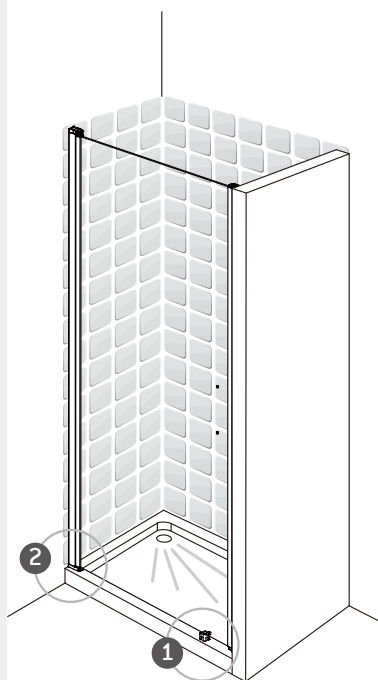
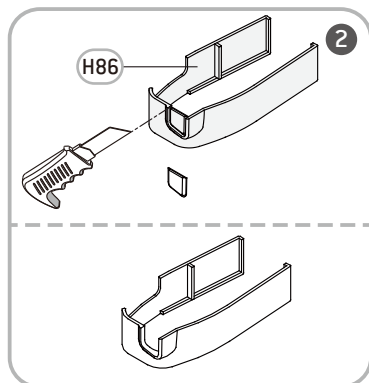
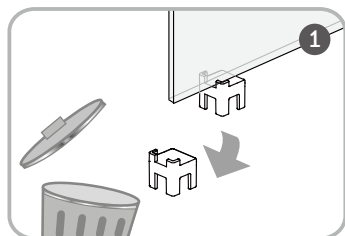
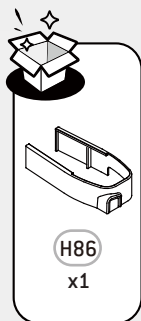

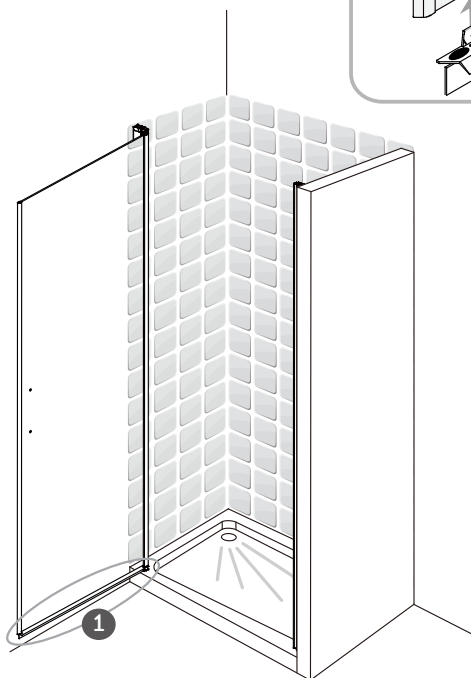
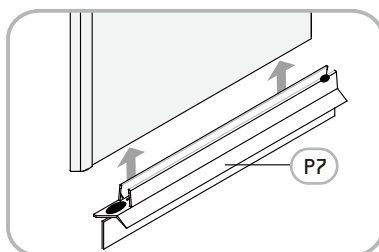
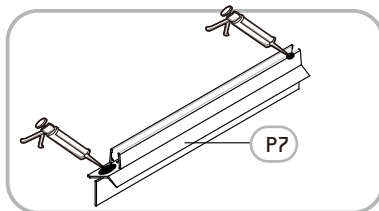
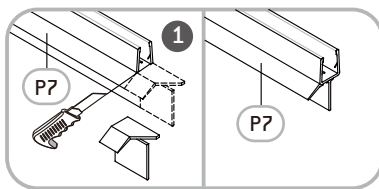

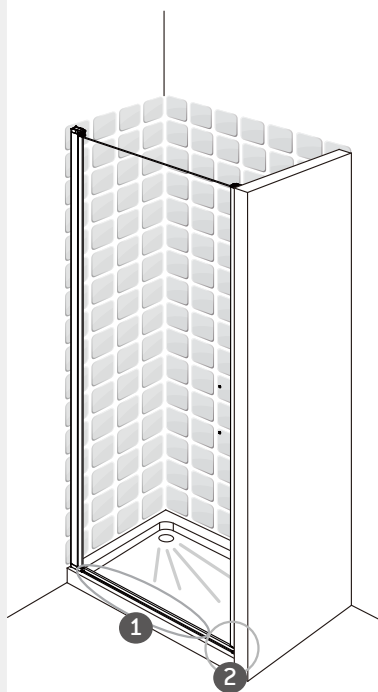
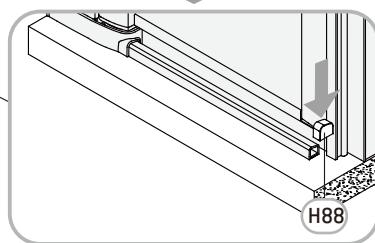
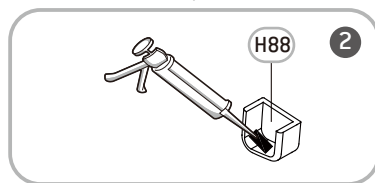
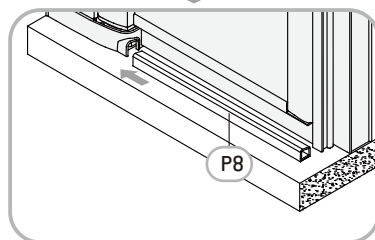
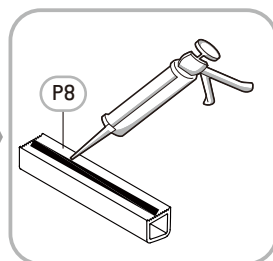
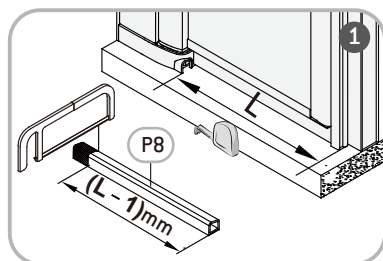
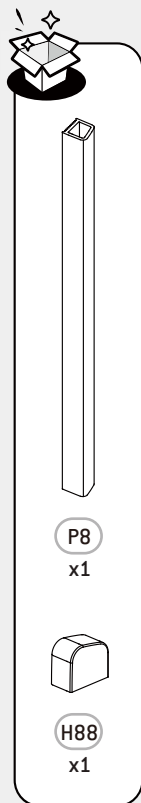

21

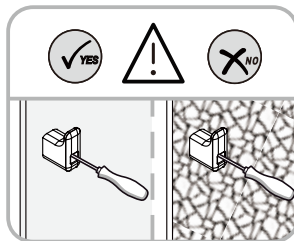
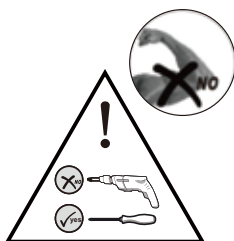
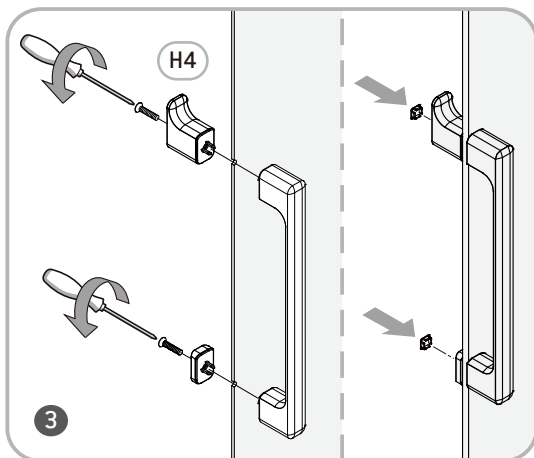
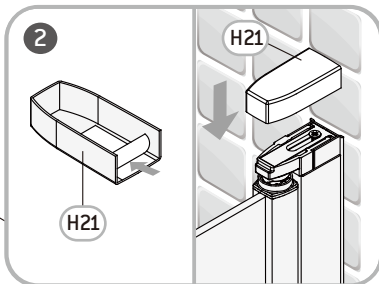
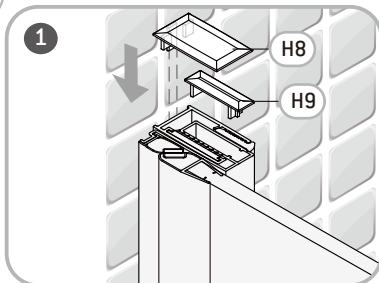
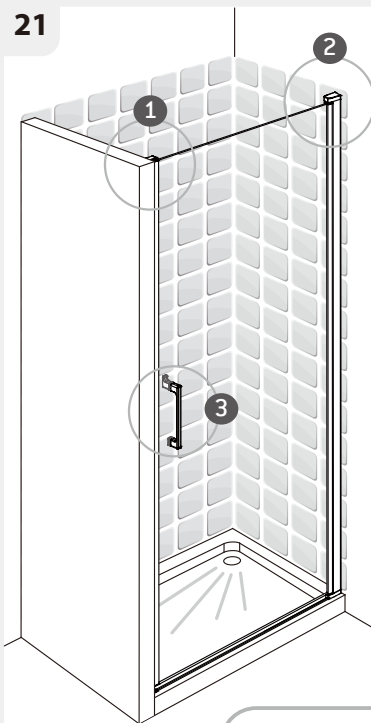
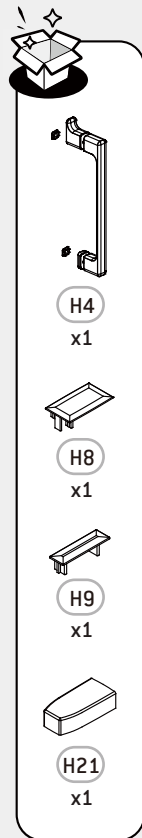



22

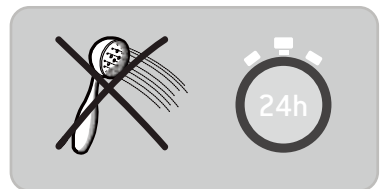
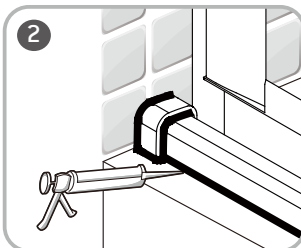
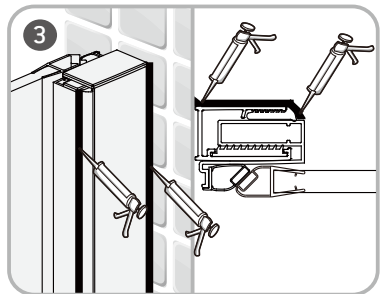
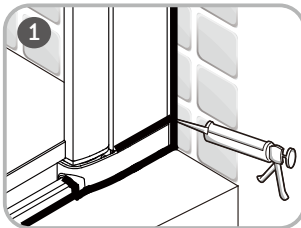
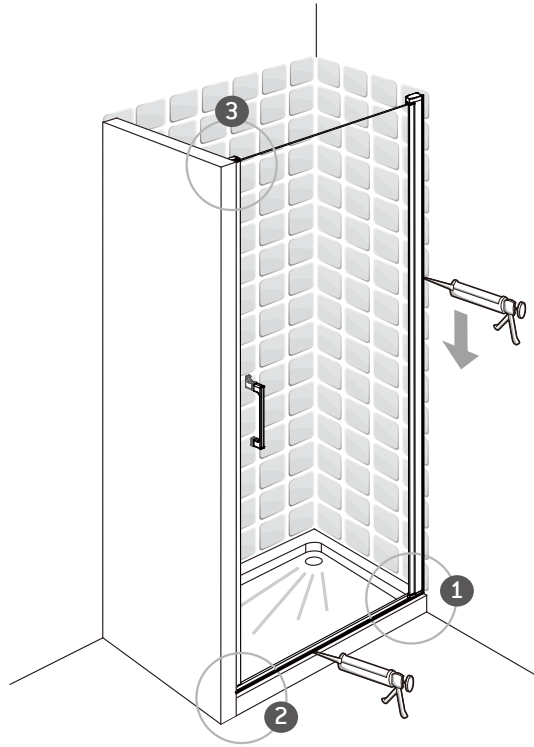



i



Eau claire / Agua limpia / Água limpa / Acqua pulita / Καθαρό νερό / Czysta woda / Чистая вода / Água limpa /
Чиста вода / Apa curata / tassa cy / Clean water



Sans solvant / Sin disolvente / Sem solventes / Senza solventi / Χωρίς διαλυτικά / Bez rozpuszczalnika / Без растворителя /
Sem solventes/ Без розчинника / Fara solvent / еріткішcis/ Solvent-free

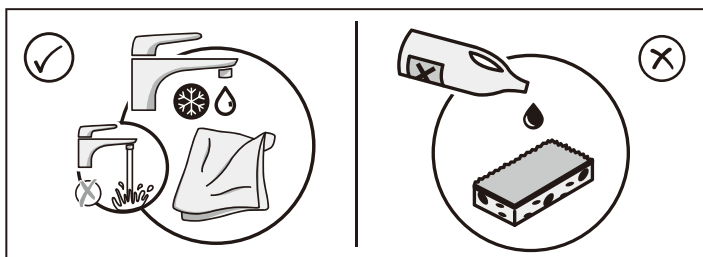



FR

CE

ADEO Services - 135 Rue Sadi Carnot -
CS 00001 59790 RONCHIN - France
19
EN 14428:2015+A1:2018

Code d'identification unique
du produit type: **

usage prévu:	hygiène personnelle
Nettoyable:	Conforme
Résistance à l'impact/ Capacité de Fragmentation:	Conforme
durabilité:	Conforme

DOP N ° 208993/0007/2019

ES

CE

ADEO Services - 135 Rue Sadi Carnot -
CS 00001 59790 RONCHIN - France
19
EN 14428:2015+A1:2018

Código de identificación
única del producto tipo: **

Uso previsto:	higiene personal
Limpiable:	Conforme
Resistencia al impacto/ Capacidad de fragmentación:	Conforme
Durabilidad:	Conforme

DOP N ° 208993/0007/2019

PT

CE

ADEO Services - 135 Rue Sadi Carnot -
CS 00001 59790 RONCHIN - France
19
EN 14428:2015+A1:2018

Código de identificação
único do produto-tipo: **

Utilização prevista:	higiene pessoal
Limpeza:	Conforme
Resistência ao impacto/ Capacidade de fragmentação:	Conforme
Durabilidade:	Conforme

DOP N ° 208993/0007/2019

IT

CE

ADEO Services - 135 Rue Sadi Carnot -
CS 00001 59790 RONCHIN - France
19
EN 14428:2015+A1:2018

Codice di identificazione
unico del prodotto-tipo: **

Uso previsto:	igiene personale
Pulibile:	Conforme
Resistenza agli urti/ Capacità di Frammentazione:	Conforme
Durata:	Conforme

DOP N ° 208993/0007/2019

EL

CE

ADEO Services - 135 Rue Sadi Carnot -
CS 00001 59790 RONCHIN - France
19
EN 14428:2015+A1:2018

Μοναδικός κωδικός ταυτοποίησης
του τύπου του προϊόντος: **

προβλεπόμενη χρήση:	προσωπική υγιεινή	
Δυνατότητα καθαρισμού:	Σύμφωνος με	
Απόγνιξη σε κρούση/	Κανονότητα κατάτμησης:	Σύμφωνος με
Διάρκεια:	Σύμφωνος με	

DOP N ° 208993/0007/2019

PL

CE

ADEO Services - 135 Rue Sadi Carnot -
CS 00001 59790 RONCHIN - France
19
EN 14428:2015+A1:2018

Niepowtarzalny kod
identyfikacyjny typu wyrobu: **

przeznaczenie:	higiena osobista
Możliwość czyszczenia:	Zgodny
Odporność na uderzenia/ Rozkruszalność:	Zgodny
Trwałość:	Zgodny

DOP N ° 208993/0007/2019

RO

CE

ADEO Services - 135 Rue Sadi Carnot -
CS 00001 59790 RONCHIN - France
19
EN 14428:2015+A1:2018

Cod unic de identificare
a tipului de produs: **

destinație:	igienă personală
Posibilitatea de curățare:	Conform
Rezistență la impact/ Capacitate de fragmentare:	Conform
Durabilitate:	Conform

DOP N ° 208993/0007/2019

EN

CE

ADEO Services - 135 Rue Sadi Carnot -
CS 00001 59790 RONCHIN - France
19
EN 14428:2015+A1:2018

Unique identification code
of the product-type: **

intended use:	personal hygiene
cleanability:	Pass
Impact resistance/ shatter properties:	Pass
Durability:	Pass

DOP N ° 208993/0007/2019

**

FR Reportez-vous à l'annexe.

ES Consulte el apéndice.

PT Consulte o anexo.

IT Consultare l'appendice.

EL Ανατρέξτε στο Παράρτημα.

PL Patrz załącznik.

RO Consultați anexa.

EN Refer to appendix.



CE

* Garantie 10 ans / 10 años de garantía / Garantia de 10 anos / Garanzia 10 Anni / Εγγύηση 10 ετών /
Gwarancja 10-letnia / Гарантия 10 года / Кепілдік 10 жыл / Гарантія 10 років / Garantie 10 ani /
10-year guarantee

Made in P.R.C. 2019

ADEO Services - 135 Rue Sadi Carnot - CS 00001
59790 RONCHIN - France

ТОВ «Леруа Мерлен Україна»,
вул. Полярна 17а, м. Київ 04201, Україна

LM - 188, Building 4, 2 Dajiaoting Zhongjie, Chaoyang District,
Beijing 100022 - CHINA, P.R.C

ООО ЛЕРУА МЕРЛЕН ВОСТОК, 141031, Московская
область, Мытищинский район, г. Мытищи,
Осташковское шоссе, д.1, РОССИЯ

Importado e distribuído por LEROY MERLIN
CIA BRASILEIRA DE BRICOLAGEM
Rua Domingas Galleri Blotta, 315 - Interlagos - CEP
04455-360 - São Paulo - SP - Brazil (CNPJ: 01.438.784/0001-05
CALM (Central de Atendimento Leroy Merlin) -4020.5376 (capitais)
e 0800.0205376 (demais regiões)

Imported by Adeo South Africa (PTY) LTD T/A Leroy Merlin
Leroy Merlin Greenstone Store - Corner Blackrock Street
and Stoneridge Drive, Greenstone Park Ext 2,
Edenvale, 1610 - Johannesburg, Gauteng, South Africa

«Леруа Мерлен Қазақстан» ЖШС Қазақстан
Республикасы, 050000, Алматы қ., Қонаев
көшесі, 77, «ParkView» БО, бқ, 07 оф.



FR/ Annexe	ES/ Apéndice	PT/ Anexo	IT/ Appendice
EL/ Παράρτημα	PL/ Załącznik	RU/ Приложение	UA/ Додаток
RO/ Anexa	EN/ Appendix		

EAN CODE	**MODEL NO.	SIZE(MM)	PROFILE
3276000693277	RE2-PI80-M-C	800x1950	MAT BLACK
3276000693253	RE2-PI80-S-C	800x1950	BRIGHT CHROME
3276000693260	RE2-PI80-S-F	800x1950	BRIGHT CHROME
3276000692904	RE2-PI90-M-C	900x1950	MAT BLACK
3276000693284	RE2-PI90-S-C	900x1950	BRIGHT CHROME
3276000692898	RE2-PI90-S-F	900x1950	BRIGHT CHROME
3276000692935	RE2-PI100-M-C	1000x1950	MAT BLACK
3276000692911	RE2-PI100-S-C	1000x1950	BRIGHT CHROME
3276000692928	RE2-PI100-S-F	1000x1950	BRIGHT CHROME