

FAR TOOLS®

- FR** Renovateur de finition (Notice originale)
- EN** Finishing renovator (Original manual translation)
- DE** Abschluss der Renovierung (Übersetzung aus dem Original-Anleitung)
- ES** Renovador de acabado (Traducción del manual de instrucciones originale)
- IT** Rinnovatore di finitura (Traduzione dell'avvertenza originale)
- PT** Renovador de acabamento (Tradução do livro de instruções original)
- NL** Renovatie afwerking (Vertaling van de originele instructies)
- EL** Ολοκληρώνοντας τον ανακαινιστή (Μετάφραση από τις πρωτότυπες οδηγίες)
- PL** Remont wykończeniowy (Tłumaczenie z oryginalnej instrukcji)
- FI** Viimeistely remontoija (Käännös alkuperäisestä ohjeet)
- SV** Efterbehandling renoverare (Översättning från originalinstruktioner)
- BU** Довършителен ремонт (Превод на оригиналната инструкция)
- DA** Efterbehandling renovering (Oversættelse fra oprindelige brugsanvisning)
- RO** Renovator de finisaje (Traducere din instrucțiunile originale)
- RU** Отделочный ремонт (Перевод с оригинальной инструкции)
- TU** Bitirme renovator (Orijinal talimatlar çeviri)
- CS** Dokončovací restaurátor (Překlad z originálního návodu)
- SK** Dokončovací reštaurátor (Preklad z originálneho návodu)
- HE** בקמ שיטפ (שיפוץ גמר)
- AR** ح ل ص م ل بي ط ش ت ل ا
- HU** Befejező felújító (Fordítás az eredeti utasítások)
- SL** Dokončni obnovitelj (Prevod iz izvirnih navodil)
- ET** Viimistlus renoveerija (Tõlge originaal juhiseid)
- LV** Apdares renovators (Tulkojumā no instrukcijas oriģinālvalodā)
- LT** Apdailos renovatorius (Vertimas iš originalių instrukcijas)
- HR** Dovršivač (Prijevod prema originalne upute)



REX 80
Professional Machine



© FAR GROUP EUROPE

115018-Manual-A-20190904



www.fartools.com



Description et repérage des organes de la machine
Description and location of machine parts

A

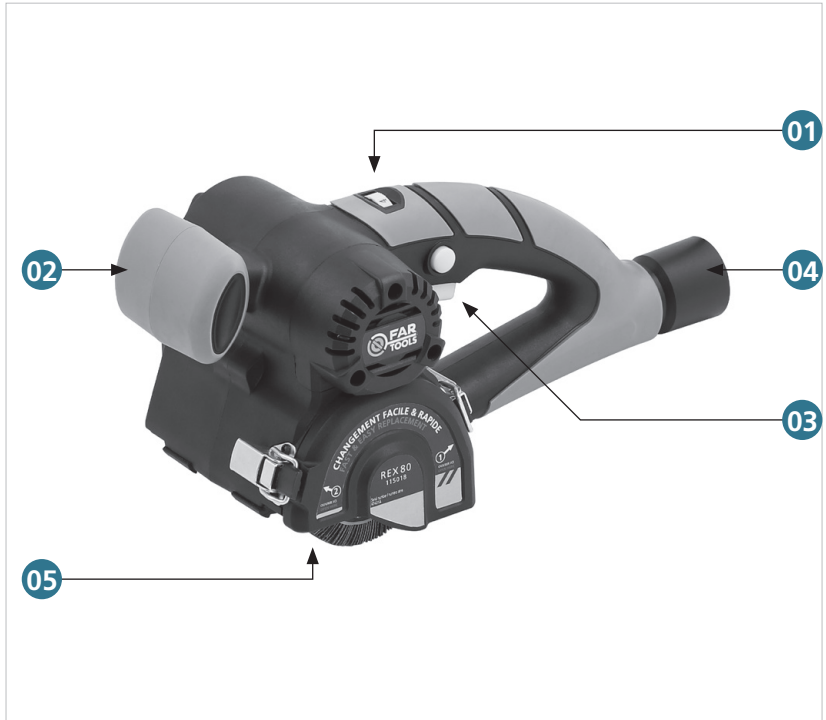

Contenu du carton
Contents of box

C



D

02

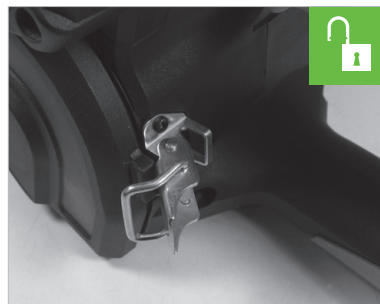
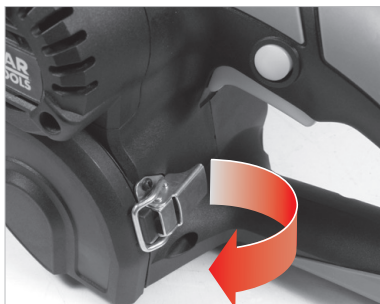
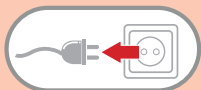

03

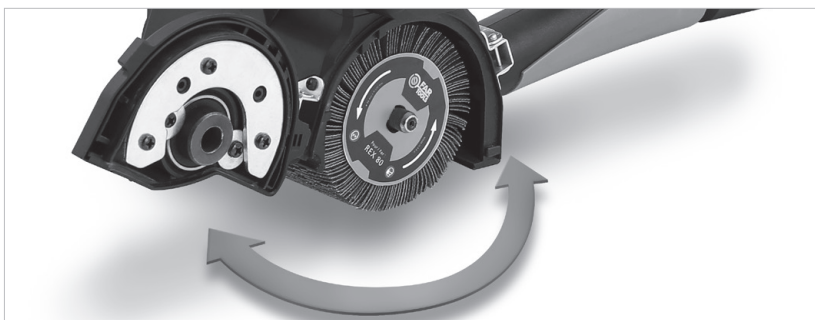
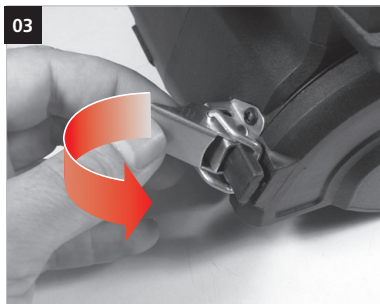

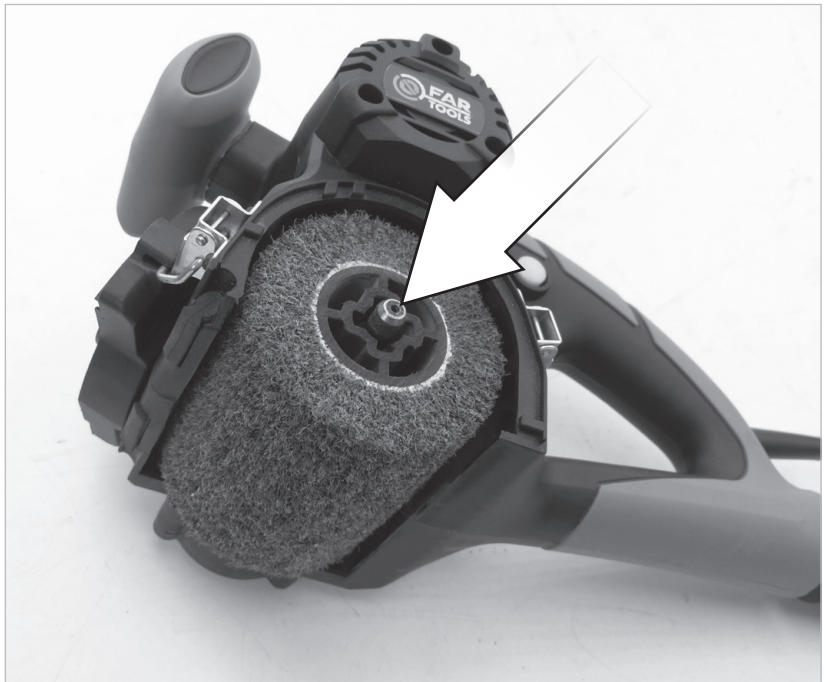
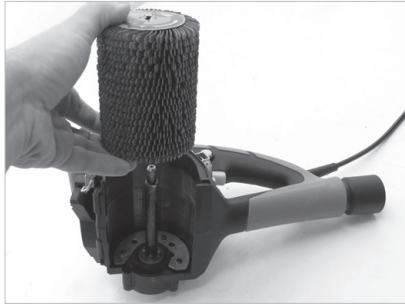
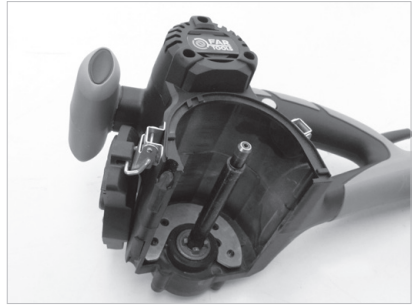
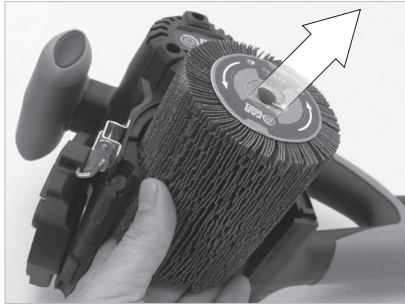



Fonctionnalité de la machine
Functions of the machine

E

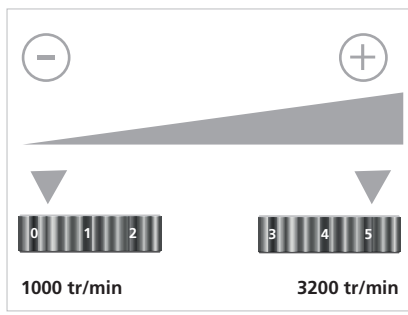
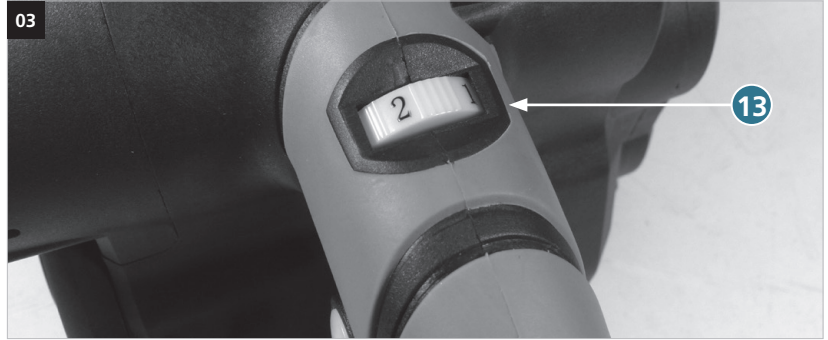
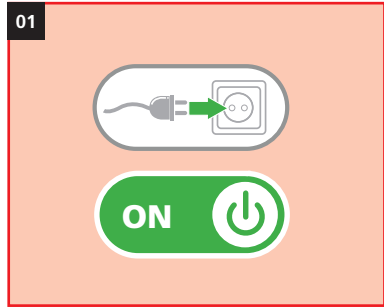

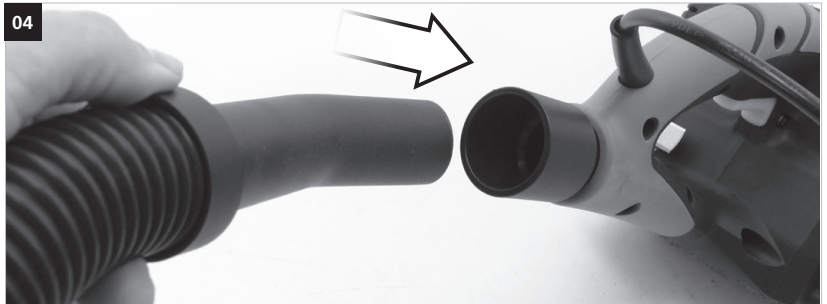

Remplacement des
consommables
Consumables
replacing

G

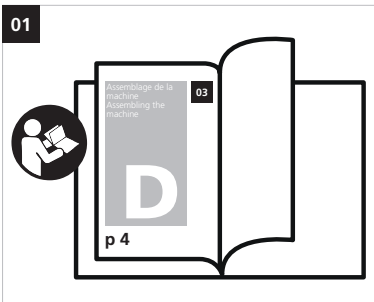



110891:
Brosse fil laitonée 0,3 mm
Staalborstel messing 0,3 mm
0,3 mm cepillo de alambre de latón
0,3 milímetros escova de arame de bronze
0,3 millimetri spazzola metallica di ottone
0.3 mm brass wire brush



110892:
Brosse Nylon avec fil enrobé d'abrasif
Nylon gecoatete draad borstel met schurende
Cepillo de alambre revestido de nylon con abrasivos
Escova de fio de nylon revestido com abrasivo
Spazzola di filo rivestito in nylon con abrasivo
Nylon coated wire brush with abrasive





110893:
Brosse à lamelles
Flap Brush
Solapa cepillo
Escova Flap
Spazzola Flap
Flap Brush





110894:
Brosse fibre synthétique
Synthetische vezel penseel
Pincel de fibra sintética
Escova de fibra sintética
Pennello in fibra sintetica
Synthetic fiber brush

	<p>Tension et fréquence assignée: Nominal frequency and power: Spannung und Frequenz: Tensión y frecuencia fijada: Tensione e frequenza assegnata: Tensão e frequência fixa: Aangewezen spanning en frequentie: Ονομαστική τάση και συχνότητα: Napięcie i częstotliwość przydzielona: Jännite ja määrätty taajuus: Angiven spänning och frekvens: Anført spænding og frekvens: Tensiune și frecvență de lucru:</p>	<p>Заданное напряжение и частота: Tahsis gerilimi ve frekansi: Stanovené napětí a frekvence: Stanovené napätie a frekvencia: מחמת ותדר מוקצב الغلطية والذبذبة المبرمجة. Névlleges feszültség és frekvencia: Napetost in določena frekvenca: Консумирано напрежение и честота : Määratud pinge ja sagedus Nustatytá ětampa ir dažnis Noteiktais spriegums un frekvence. Napon i nazivna frekvencija:</p>	230 V ~ 50 Hz
---	--	--	----------------------

	<p>Puissance assignée: Nominal power: Leerlaufdrehzahl: Potencia fijada: Potenza assegnata: Potência assinada: Onbelast toerental: Ονομαστική ισχύς : Prędkość na biegu jałowym: Teho: Angiven effekt: Anført styrke: Putere de lucru:</p>	<p>Заданная мощность: Tahsis edilen güç: Stanovený příkon: Predpísaný výkon: מוח מוקצב. القدرة المبرمجة. Névlleges teljesítmény : Določena jakost: Консумирана мощност: Määratud võimsus. Nustatytá galia Noteiktá jauda Nazivna snaga:</p>	420 W
---	--	--	--------------

	<p>Classe d'isolement : 2 Insulation class : 2 Isolierung klasse : 2 Aislamiento clase :2 Isolamento classe :2 Isolamento classe :2 Isolatie Klasse : 2 Εργαλειο τάξη: 2 Izolacja Klasy :2 Eristysluokka :2 Isolering Klass :2 Isoleringsklasse 2 Clasă izolație :2</p>	<p>Класс изоляции 2 : Yalıtım derecesi :2 Třída izolace :2 Izolačný systém 2 סוג בידוד 2 فئة العزل 2. Szigetelési osztály :2 Razred izolacije :2 Инструмент Клас :2 Isolatsiooniklass 2 Izolacijjos rūšis 2 Izolācijas klase 2 Izolacija klasa: 2</p>	X
--	---	--	----------

	<p>Vitesse à vide: No-load speed: Drehzahl unbelastet: Velocidad vacía: Velocità a vuoto: Velocidade no vácuo: Leerlaufdrehzahl: Ταχύτητα στο κενό: Prędkość bez bciążenia: Tyhjäkäyntinopeus Tomgångshastighet: Hastighed i ubelastet tilstand: Viteza în gol:</p>	<p>Скорость вращения на холостом ходу: Boşalma hızı: Rychlost naprázdno: Rýchlost' pri chode naprázdno: מהירות ריק. السرعة على الفارغ. Üres sebesség: Prosti tek: Скорост на празни обороти: Kiirus tühikäigul Tuščio prietaiso greitis Tukšgaitas ātrums Brzina praznog hoda:</p>	1000-3200 min⁻¹
---	---	---	-----------------------------------

	Porter des lunettes de sécurité : Wear protective eyewear : Schutzbrille tragen : Llevar puestas gafas protectoras : Portare de gli occhiali di sicurezza : Utilizar óculos de segurança : Draag een veiligheidsbril : Φορέστε Προστατευτικά γυαλιά : Zakładać okulary ochronne : Käytä suojalaseja : Använd skyddsglasögon : Der skal benyttes sikkerhedsbriller : Purtati ochelari de protectie :	Наденьте защитные очки : Güvenlik gözlükleri takın : Používejte bezpečnostní brýle : Noste ochranné okuliare : נחשתם יפקשמ ביכרהל אנ جمل نظارات وقاية. Viseljen védőszemüveget : Nositi zaščitna očala : Да се използват защитни очила : Kandke kaitseprille Nešioti apsauginius akinius Valkät aizsargbrilles Nositi zaštitne naočale:	X
---	---	---	---

	Porter un masque anti-poussière : Wear a dust mask : Staubschutzmaske tragen : Llevar puesta una careta de protección contra el polvo : Indossare una mascherina anti-polvere : Utilizar uma máscara anti-poeira : Draag een stofmasker : χρήση προστατευτική μάσκα : Zakładać maskę przeciwpyłową Käytä pölysuojust : Bär mask mot damm : Der skal benyttes beskyttelsesmaske mod støv: Purtati mască anti-praf :	Наденьте респиратор : Toza karşı maske takın : Používejte masku proti prachu : Noste ochrannú masku proti prachu : קבא דגן הכסמ שובחל אנ لبس قناع مضارض للغبيار. Viseljen porvédő maszkot Nositi zaščitno masko proti prahu: Да се използва защитна маска : Kandke tolmumaski. Dévėti respiratorių Valkät aizsarg masku pret putekļiem Nositi masku za zaštitu od prašine:	X
---	--	--	---

	Porter une protection auditive : Wear hearing protective equipment: Gehörschutz tragen: Llevar puesta una protección auditiva: Portare una protezione uditiva: Utilizar uma protecção auditiva: Draag gehoorbeschermers: Φορέστε Προστατευτικά ακουστικά Zakładać słuchawki ochronne Käytä kuulosuojaimia: Bär hörselskydd: Der skal benyttes høreværn: Purtati căști de protectie auz:	наденьте средства звуковой защиты: İşitsel koruma aleti takın: Používejte ochranu sluchu: Noste ochranné slúchadlá: יש ל הרכיב הגנת שמיעה لبس خوذة ضوضاء الخرجىج Viseljen fülvédő Nositi zašito ušes: Да се използва слухови защитни средства: Kandke kõrvakaitset Nešioti apsaugą nuo triukšmo Valkät dzirdes aizsarglīdzekli Nositi štitnike protiv buke:	X
--	---	---	---

	Porter des gants : Use rubber gloves : Schutzhandschuhe tragen : Llevar guantes de protección : Indossare i guanti di protezione : Utilizar luvas de protecção : Draag veiligheidshandschoenen : χρήση προστατευτικών γαντιών : Używać rękawic ochronnych : Käytä suojakäsineitä : Använd skyddshandskar : Der skal benyttes handsker : Purtati mănuși :	Наденьте перчатки : Eldiven takın : Noste rukavice : Noste rukavice : תופכ שובלל אנ لبس قفازات. Viseljen kesztyű t Nositi rokavice: а се използват предпазни ръкавици : Kandke kindaid Müvėti pirštines Valkät cimduš Nositi zaštitne rukavice:	X
---	--	---	---

	<p> Lire les instructions avant usage : Read the instructions before use : Vor Einsatz des Geräts Anweisung lesen : Léase las instrucciones antes de usar : Leggere le istruzioni prima dell'uso : Ler as instruções antes da utilização : Διαβάστε τις οδηγίες χρήσης : Zapoznać się instrukcją przed użyciem : Lue ohjeet ennen käyttöä : Läs anvisningarna före användning : læs instruktionerne før brug Înainte de utilizare, citiți instrucțiunile : </p>	<p> Внимательно прочитайте следующие инструкции : Kullanmadan talimatları okuyunuz : Pozorně si přečtete následující pokyny : Pred použitím si prečítajte pokyny : זרם הילופי اقرأ التعليمات قبل الاستخدام. használat előtt olvassuk el az utasítást : Pred uporabo preberite ustreznna navodila Прочетете указанията за употреба : Enne kasutamist lugege instruksiooni Prieš naudojimą perskaityti instrukciją izlasīt instrukcijas pirms lietošanas Pročitati upute prije uporabe: </p>	X
---	--	--	----------

	<p> Conformité européenne Conforms to EC standards : CE-Konformität : Cumples con las directivas CE : Conforme alle norme CE : Conforme às normas CE : Valdoet aan de EG-normen : Συμφώνο με τα πρότυπα Zgodność z normami CE : EU-standardien mukainen : EU-standardien mukainen : Overholder EU standarderne : Conform cu normele europene: </p>	<p> соответствие европейским стандартам: Avrupa uygunluk : evropská shoda : európska dohoda : התאמה לתקנים האירופיים مطابقت للجواصفات الأوروبية. evropska ustreznost : európai megfeleléség : Съответствие с европейските норми : Euroopa Liidu vastavusmärk Europinių normų atitikima Atbilstība Eiropas standartiem Europska sukladnost </p>	X
---	--	--	----------

	<p> Danger : Gefahr : Peligro : Pericolo : Perigo : Gevaar : Κίνδυνος : Niebezpieczeństwo : Vaara : Fara : Fare : Pericol : </p>	<p> Опасно : Tehlike : Nebezpečí : Nebezpečnstvo : סכנה. خطر. Veszély : Nevarnost: Опасно : Oht Pavojus Bīstamība Опасност: </p>	X
---	---	--	----------

	<p> Poids : Weight : Gewicht : Peso : Pesa : Pesa : Gewicht : Βάρος : Masa : Paino : Vikt : Vægt : Greutate : </p>	<p> Вес : Ağırlık : Hmotnost : Hmotnosť : משקל الوزن. Súly : Teža : Терло : Raskus Svoris Svars Težina </p>	2,7 kg
---	--	--	--------

 L_{pA}	Niveau de pression acoustique : Acoustic pressure level : Schalldruckpegel : Nivel de presión acústica : Livello di pressione acustica : Nivel de pressão acústica : Niveau akoestische druk : Στάθμη Θορύβου : Poziom mocy akustycznej : Käytä kuulosuojaimia: Ljudtrycksnivå : Lydtryk : Nivel presiune acustică :	Уровень акустического давления. : Akustik basınç seviyesi : Hladina akustického tlaku : Hladina akustického tlaku : רמת לחץ אקוסטי. مستوى الضغط السمعي. A hangnyomás szintje : Nivo akustičnega pritiska: Равнище на акустично налягане : Helirõhu nivoo Akustinio spaudimo lygis Akustiskā spiediena līmenis Razina zvučnog tlaka:	87 dB (A)

 L_{WA}	Niveau de puissance acoustique : Acoustic power level : Schallleistungspegel : Nivel de potencia acústica : Livello di potenza acustica: Nivel de potência acústica: Niveau akoestisch vermogen : Στάθμη Ονομαστική Θορύβου : Poziom mocy akustycznej : Käytä suojaalaseja : Ljudstyrkenivå : Lydstyrke : Nivel putere acustică :	уровень мощности звука : Akustik basınç seviyesi : Hladina zvukového výkonu: Hladina zvukového výkonu: רמת כוח אקוסטי. مستوى الضغط السمعي. a hangnyomás szintje : Nivo akustične jakosti : Равнище на вибрации : Helivõimsuse nivoo Triukšmo lygis Akustiskās jaudas līmenis Razina zvučne snage:	98 dB (A)

NIVEAU SONORE D'ÉMISSION :

A VIDE

Pression acoustique L_{pA} poste opérateur
Incertitude

87 dB
3

Puissance acoustique L_{WA}
Incertitude

98 dB
3

Valeurs déterminées suivant le code d'essai de l'annexe B de la norme EN 61029-1 avec emploi des normes de base ISO 11201 et ISO 3744.

Les niveaux de pression acoustique obtenus in situ dépendent:

- Des niveaux réels de la machine considérées, en prenant en compte les incertitudes déclarées;
- Du local et de l'installation de la machine. Préférez une pièce dont l'acoustique est plus feutrée. Evitez les pièces vide à grande résonance. Placez vous auprès d'une fenêtre le cas échéant.
- Des outils montés, des pièces travaillées, des réglages choisis,...

 L_{WA}	Niveau de vibration : Hand/arm vibration level : Vibrationspegel Hand/Arm : Nivel de vibración mano/brazo : Livello di vibrazione mano/braccio : Nivel de vibração mão/braço : Trillingsniveau hand/arm : Στάθμη κρατ.οασμών : Poziom wibracji rżka/ramiż : Tärinätaso: Vibrationsnivå hand/arm : Vibrationsniveau : Nivel vibratii :	Уровень вибрации : Titreşim seviyesi : Úroveň vibrací : Hladina vibrácií : רמת תנודות مستوى الارتجاج. Vibrációs szint : Nivo vibracij : Равнище : Vibrācijas līmenis. Vibrācijas lygis Vibratsiooni nivo Razina vibracije:	14,6 m / s²

VIBRATIONS:

Total des valeurs de vibration (somme vectorielle des trois directions) déterminée selon EN 60745 :

a 14,6 m/s²
Incertitude K 1,5 m/s²

L'amplitude d'oscillation peut être utilisée comme valeur de comparaison d'outils électroportatifs.

Attention : si l'outil électroportatif est utilisé pour d'autres applications, avec d'autres outils de travail, l'amplitude d'oscillation peut être différente.

	<p>Soumis à recyclage Subjected to recycling Sujeto a reciclaje Sottoposti a riciclaggio Sujeitos à reciclagem Não deite no lixo : Niet wegwerpen : Μην την πετάτε : Nie wyrzucas : Älä heitä pois luontoon : Batteriet får inte kastas : Bortkast det ikke: Nu le auncati :</p>	<p>Не выбрасывайте в мусорный ящик Atmayiniz : Nevyhadzujte je do bežného odpadu : Neodhadzovat : אין לזרוק סוללות فلا ترمها ملذا في القمامة. ne mečite 1 Ne odvržite ga/jih vstran : He го изхвърляйте : Ärge visake seda minema : Nemetykíte : Nemest : Podvrgnuto recikliranju</p>	X
---	--	---	---

Recyclage des déchets :

Les outils, accessoires et leur emballages doivent suivre une voie de recyclage adaptée. Conformément aux directives Européenne 2012/19/UE et 2006/66/CE, les composants d'un produit doivent être séparés, collectés, recyclés ou éliminés en conformité avec les réglementations environnementales en vigueur. Les appareils, batteries, piles, huiles, emballages devront être déposés dans les systèmes d'élimination des déchets spéciaux tels que déchetteries. Renseignez-vous auprès de votre commune pour connaître l'organisme le plus proche à même de traiter ou de collecter ces déchets.

	<p>Recyclable, soumis au tri sélectif Recyclable, subject to recycling Recyclingfähige, unterliegen Recycling Reciclables, sujetos a reciclaje Riciclabili, soggetti a riciclaggio Recicláveis, sujeito à reciclagem Recycleerbare, onderworpen aan recycling Ανακυκλώσιμες συσκευασίες που υπόκεινται σε κύκλωση Opakowanie nadaje się do recyklingu podlegają recyklingu Kierrätettävien pakkausten kohteena kierrätys Återvinningsbara förpackningar omfattas återvinning Рециклиращи се опаковки подлежат на рециклиране Genanvendelig underlagt genbrug</p>	<p>Reciclabile sub rezerva reciclare Повторно опаковка подлежит вторичной переработке Gerí dönüřüm Geri dönüřtürülebilir ambalaj konusu Recyklovateľné podľehajúci recyklácii Recyklovateľné podliehajúce recyklácii רוחמל ורוחמל הייראה אשונ ريوندلا دا اعال غرض عن ريوندلا دا اعال قبايلا فيل اعال غرض Újrahasznosítható csomagolás alá újrahasznosítás Reciklirati predmet recikliranja Pakendite suhtes ringlussevõtu Pärsträdåjams iepakojums otrreizējai pārstrādei Perdirbamų taikomos perdirbimo Može se reciklirati, podložno selektivnom sortiranju</p>	X
---	---	--	---

	<p>Diamètre de brosse et largeur : Diameter of wheel and width : Bürstendurchmesser und Breite : Cepillar diámetro y anchura: Escovar diâmetro e largura: Spennellare diametro e larghezza: Borstel diameter en breedte: Διάμετρο δίσκου : Średnica tarczy i otwór : Leikkuuterän läpimitta ja kalviminen : Skivans diameter och innerdiameter : Skivens ydre og indre diameter : Diametru disc și alezaj :</p>	<p>Диаметр диска и пропила : Disk ve delik çapı : Průměr kotouče a vrtání : Priemer kotúča a vnútorný priemer : קוטר הדיסקה וקידוד قطر الأسطوانة والتجويف A tárcsa és a furat mérete : Premer diska in izvrtine : Диаметър на резеца : Ketta ja puurimise diameeter : Skersmuo : Diska un caurplūdes atvērums diametrs : Promjer četke i širina:</p>	ø 80 x 100 mm
---	---	---	---------------

REX 80

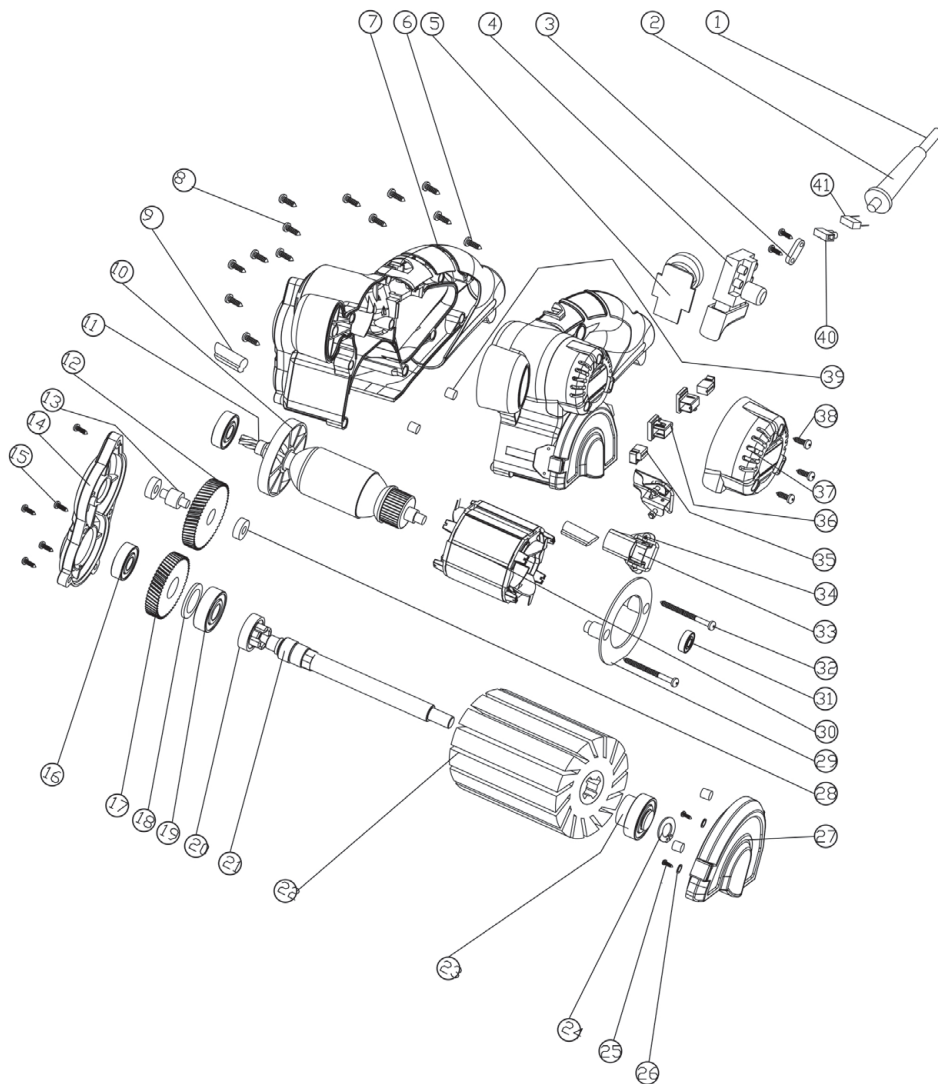

DECLARATION DE CONFORMITE
VERKLARING VAN OVEREENSTEMMING
DECLARACION DE CONFORMIDAD
DICHIARAZIONE DI CONFORMITA
KONFORMITÄSERKLÄRUNG
DECLARATION CONFORMITY
DECLARAÇÃO DE CONFORMIDADE
DEKLARACJA ZGODNOSCI Z NORMAMI
OM ÖVERENSSTÄMMELSE
VAATIMUSTENMUKAISUUSVAKUUTUS
OVERENSSTEMMELSESERKLÆRING
Δήλωση συμμόρφωσης/συμμόρφωσης

DECLARAȚIE DE CONFORMITATE
VYHLÁSENIE ZHODY
Декларация соответствия
תצהיר תואמת
Uygunluk beyanı
التصريح بالمتطابق
PROHLÁŠENÍ SHODY
EGYZEZŐSÉGI NYILATKOZAT
Декларация за съответствие с нормите
IZJAVA O SKLADNOSTI
DEKLARACIJA
ATITIKTIES DEKLARACIJA
KINNITUS
IZJAVA O SUKLADNOSTI

Le soussigné,
Ondergetekende,
Der Untérzeichner,
O abaixo assinado,
Undertecknad,
Долуподписаният
Undertegnede
Subsemnatul,
Я, нижеподписавшийся,
Imzalıyan,
Níže podepsaný,
Toliau pasirašęs

Déclare par la présente que,
Verklaart hiermede dat,
Erklärt hiermit daß,
Declara pela presente que,
Förklarar härmed att
Заявляя с настоящего
erklærer hermed, at
Declar prin prezenta că,
настоящим подтверждаю, что
Mevcut belgeyle beyan ediliyor ki,
tímto prohlašuje, že,
Pareiškia, kad,

Personne autorisée à constituer
le dossier technique :
Christophe HUREL



FAR GROUP EUROPE
192, Avenue Yves Farge
37700 St. Pierre-des-Corps
FRANCE

El suscrito,
Il sottoscritto,
The undersigned,
Ninej podpisany
Allékirjoittanut,
Ουπεργραμμένος
Nizšie podpisany
החתום מטה,
الوقيع أدناه
Alulírott,
Podpisani,
Apakšā parakstijies
allakirjutanu
Dolje potpisani,

Declara por la presente, que,
Dichiare che,
Declares that,
OOwiadcza niniejszym, że
Ilmoitetaan täten että,
Δηλώνω με την Παράστα
týmto vyhlásume, že
מצהיר בזה כי
يصرح استنادا على ذلك
Pareiškia, kad,
Ar šo apliecinā, ka,
Kinnitab, et
izjavljuje u ovom dokumentu da je

*Renovateur extérieur / Exterior renovator / Schleif- und Renoviergerät / Fuera renovador / Restauratore di fuori / Fora renovador / Buiten renovator /
έξω από ανακαίνισης / Poza renovatora / Ulkopuolella remontoijille / Utanför renovator / Внешне обновитель / Udenfor renovator / In afara renovator /
Bue peccaapapopa / Yenileyen dışında / Mimo renovátor / Mimo renovátor / קנינופיש פורמט / كليم جراح / Kivül renovator / Zunaž Obnovilac / Ónes renovator /
ārpus atjaunoitājs / Už Restorer / Vanjski renovator*

code

FARTOOLS / 115018 / REX 80 / JD2676

Est conforme et satisfait aux directives et normes CE,
In overeenstemming is met en Voldoet aan EG richtlijnen,
Den folgenden EU-Bestimmungen entspricht,
Respeita e está em conformidade com as normas CE,
Överensstämmer med och uppfyller EG-standarder,
Съответства и отговаря европейските норми
Er i overensstemmelse med og overholder EU
standarderne
Este conform și satisface normele CE
полностью соответствует и удовлетворяет
требованиям стандартов ЕС
CE şartlara uygundur,
opdivoidā normām ES.
Atitinka ir atitinka EB direktyvas ir standartus,

Cumple con la directivas de la CE,
E conforme alle direttive CEE,
Complies with the EEC directives and standards,
Odpowiada normom UE,
Täyttää EU-vaatimukset,
Είναι συμμόρφωμο και αντάλλοκρύνεται στα Πρωτόλλα CE
zodpovedá normám ES.
מתאים ועונה לתקני CE
بان الجواز يتطابق و يلبي معايير مجموعة الدول الأوروبية
kielegít a CE szabványok előírásait.
Je v skladu z in izpolnjuje norme Evropske skupnosti.
Atbilst un atbilst EK direktīvas un standartus,
Vastab ja vastab EU direktiividele ja standarditeile,
Sukladan i ispunjava direktive i standarde CE,

2014/30/EU MD :2006/42/EC 2015/863/EU
2011/65/EU

EN55014-1:2017
EN55014-2:2015
EN61000-3-2:2014
EN61000-3-3:2013
EN62841-1:2015
EN62841-2-4:2014

Christophe HUREL,
Président Directeur Général
08/11/2019
Fait à St. Pierre-des-Corps

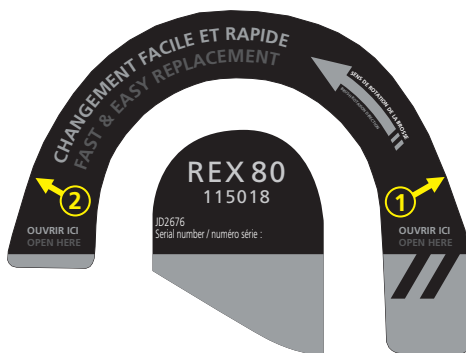
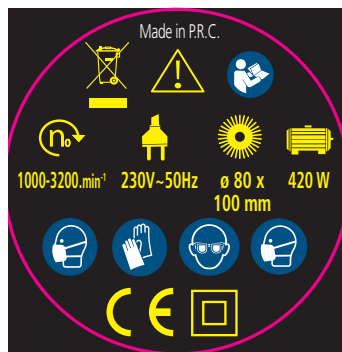



FR. GARANTIE

Cet outil est garanti contractuellement contre tout vice de construction et de matière, à compter de la date de vente à l'utilisateur et sur simple présentation du ticket de caisse. La garantie consiste à remplacer les parties défectueuses. Cette garantie n'est pas applicable en cas d'exploitation non conforme aux normes de l'appareil, ni en cas de dommages causés par des interventions non autorisées ou par négligence de la part de l'acheteur. La garantie ne s'applique pas sur les dommages causés par une défaillance de l'outil.

DE. GARANTIE

Die Garantiezeit für dieses Gerät in bezug auf Konstruktions- und Materialfehler beträgt lt. Vertrag bei Vorlage des Kassensbons. Die Garantieleistung besteht im Ersatz schadhafter Teile. Die Garantie erlischt bei einen Einsatz des Geräts, der nicht normentsprechend ist, bei Schäden, die auf unsachgemäße Eingriffe zurückzuführen sind bzw. bei Nachlässigkeit seitens des Käufers. Die Garantie erstreckt sich nicht auf Schäden, die auf Fehlfunktionen des Geräts zurückzuführen sind.

IT. GARANZIA

Quest' attrezzo è garantito per contratto contro qualsiasi difetto di costruzione e di materia, a partire dalla data di vendita all' utente e su semplice presentazione dello scontrino. La garanzia consiste nel sostituire le parti difettose. Questa garanzia non è applicabile in caso di sfruttamento non conforme alle norme dell' apparecchio, né in caso di danni causati da interventi non autorizzati o da negligenza da parte dell' acquirente. La garanzia non si applica ai danni causati da un'avarità dell'attrezzo.

EN. GARANTIE

This tool is guaranteed, in writing, against any defect in manufacture or parts from the date of sale, upon simple presentation of the sales slip. The guarantee is limited to the replacement of faulty parts. This guarantee is not applicable in the event of usage which is not conform with the intended usage of the apparatus, nor in the event of damage caused by unauthorised servicing or negligence on behalf of the purchaser. This guarantee does not apply to any damage caused by the failure of this tool.

ES. GARANTIA

Esta herramienta se garantiza contractualmente contra todo defecto de construcción y materia, a partir de la fecha de venta a l' usuario y sobre

simple presentación del recibo de caja. La garantía consiste en sustituir a las partes defectuosas. Esta garantía no es aplicable en caso de explotación no conforme a las normas del aparato, ni en caso de daños causados por intervenciones no autorizadas o por negligencia por parte del comprador. La garantía no se aplica sobre los daños causados por un fallo del herramienta.

NL. GARANTIE

Dit gereedschap heeft een garantie tegen constructiefouten en materiaaldefecten, die geldig is vanaf de aankoopdatum door de gebruiker, op vertoning van de kassabon. De garantie betreft de vervanging van de defecte onderdelen. Deze garantie is niet van toepassing indien het apparaat niet volgens de normen gebruikt is, noch in geval van schade veroorzaakt door oneigenlijk gebruik of nalatigheid van de koper. De garantie is niet van toepassing op schade voortvloeiend uit een defect van het gereedschap.

PT. GARANTIA

Esta ferramenta tem uma garantia contratual contra qualquer defeito de construção e de material, a partir da data de venda ao utilizador e sobre simples apresentação do talão da caixa.. A garantia consiste em substituir as partes defeituosas. Esta garantia não é aplicável no caso de exploração não conforme às normas do aparelho, nem em caso de danos causados pelas intervenções não autorizadas ou por negligência da parte do comprador. A garantia não se aplica para os danos causados por uma falha da ferramenta.

EL. ΕΓΓΥΗΤΗ

Το εργαλείο αυτό φέρει συμβατική εγγύηση για οποιούδηποτε ελαττωμα κατασκευής απ'ο την ημερομηνία Π'ολησης στο χροστη. με ΑΠΛ' Προσκόμηση της ΑΠ'ο'οειξης αγοράς. Η εγγύηση αποτελείται απ'ο την αντικατάσταση των ελαττωματικ'ων τμημ'ατων. Η Παρο'υσα εγγύηση οεν εφαρμ'οζεται σε Περίπτωση χροστης μη συμφωνηξ με τα Πρωτοπα της συσκευηξ. η σε Περίπτωση ζημι'αξ Που Προκλ'ηθηκε ΑΠ'ο μη εγκεκριμ'ενη ΕΠ'εμβαση 'η ΑΠ'ο αμ'ελεια του αγοραστ'η. Η εγγύηση "οεν εφαρμ'οζεται στις ζημι'εξ Που Προκαλο'υνται ΑΠ'ο βλ'αβη του εργαλει'ου. Σταυρου'ο κενου' Διαστημο-Παρ'εμβωμο

PL. GWARANCJA

Narz'dzie jest obj'ete gwarancją na wszelkie wady konstrukcyjne i materiałowe, licząc od daty sprzedaży u ytkownikowi i po okazaniu paragonu kasowego. Gwarancją obejmuj'e wymian' cz'Ąci wybrakowanych. Gwarancją nie znajduje zastosowania w przypadku u ytkowania niezgodnego z normami urz'adzenia, ani w przypadku szkód spowodowanych działaniami niedozwolonymi lub zaniedbaniami ze strony nabywcy. Gwarancją nie obejmuj'e szkód powstałych z powodu upadku

urz'adzenia.

SV. GARANTI

Detta verktyg har en avtalsenlig garanti mot konstruktions och materialfel, från och med tidpunkten för användarens inköp och genom uppvisning av kassavittot. Garantin består i att ersätta de bristfälliga delarna. Denna garanti gäller inte om användningen inte motsvarar apparatens standarder, inte heller vid skador som orsakas av ej tillåtna ingrepp eller på grund av köparens vårdslöshet. Garantin gäller inte förskador som orsakats av att verktyget fungerat bristfälligt.

FI. TAKUU

Tämän laitteen takuu on voimassa sopimukseenmukaisesti kattaa kaikki rakenne- ja materiaaliiviat lukien ostopäivästä kassakuitista vastaan. Takuu sisältää viallisten osien korvaamisen. Takuu ei korvaa ohjeidenvastaista käyttöä eikä valtuuttamattomien henkilöiden käsittelystä tai ostajan huoltomattomuudesta aiheutuneita vahinkoja. Takuu ei vastaa myöskään toimintahäiriöistä aiheutuneita vahinkoja.

BU. ГАРАНЦІЯ

Този инструмент е под договорна гаранция срещу всякакъв дефект в изработката и използваните материали, считано от датата на продажба на потребителя и само срещу представяне на касовата бележка. Гаранционното обслужване се състои в замяна на дефектните части. Настоящата гаранция не е валидна когато апаратът се използва по начин, несъответстващ на стандарта за работа с него, както и в случай на щети, нанесени от неоторизирани лица, или вследствие на проявена небрежност от страна потребителя. Гаранцията не покрива щети, произтекли вследствие на техническа неизправност на апарата.

DA. GARANTI

Dette værktøj er dækket af en garantikontrakt for konstruktions- og materialefejl, som gælder fra købsdatoen ved visning af kassebonen. Garantien består i at udskifte de defekte dele. Garantien dækker ikke fejl opstået som følge af anvendelse, som ikke overholder standarderne for apparatet, eller skader opstået ved ikke autoriserede indgreb eller sløshed fra brugerens side. Garantien dækker ikke skader opstået, fordi værktøjet har svigtet.

SERVICE APRÈS VENTE - AFTER SALE SERVICE

FARGROUP EUROPE - 192, Avenue Yves Farge - 37700 St. Pierre-des-Corps - FRANCE

fargroup@fargroup.net



RO. GARANTIE

Acest aparat este garantat din punct de vedere contractual impotriva tuturor viciorilor de constructie si de material, incepand de la data vanzarii lui catre utilizator si la simpla prezentare a bonului de casa. Garantia consta in inlocuirea componentelor defecte. Aceasta garantie nu se aplica in cazul exploatarei in alt mod decat cel recomandat de normele aparatului si nici in caz de stricaciuni provocate de interventii neautorizate sau prin neglijenta cumparatorului. Garantia nu se aplica asupra pagbelor cauzate de o defectare a aparatului.

RU. ГАРАНТИЯ

Данное изделие обладает имеющей силу контракта гарантией, покрывающей все возможные дефекты изготовления и материала. Гарантия вступает в силу с даты продажи изделия пользователю, для этого достаточно сохранить и предъявить полученные в кассе чек. Гарантия обязывает изготовителя заменить дефектные части изделия. В случае не соответствующего нормам использования изделия, не санкционированного демонтажа или ремонта, или небрежного обращения действие гарантии прекращается. Гарантия не покрывает ущерба, возникшего в результате сбоев в работе изделия.

TU. GARANTI

Bu arac, satis tarihinden itibaren, kullanicinin saadesi vezne alindisini sunmasıyla tum uretim ve malzeme hatasina karshi garantilidir. Garanti eksik olan kisimlari degistirmek icindir. Bu garanti aracin sartlarina uygun olmayan isleme durumundan izin verilmeden kullanimlardan kaynaklanan hasarlarda veya alininin isticigi durumunda uygulanmaz. Garanti malzemenin bir eksikliginden meydana gelen bir zararda uygulanmaz.

CS. ZÁRUKA

Pro tento nástroj platí smluvní záruka na všechny výrobní a materiálové vady od data prodeje uživateli a na základě předložení pokladního bloku. Záruka spočívá ve výměně vadných částí. Tato záruka neplatí v případě použití přístroje, které neodpovídá normám, ani v případě škod způsobených nepovolenými zásahy nebo nedbalostí ze strany kupujícího. Záruka se nevztahuje na škody způsobené závadou nástroje.

SK. ZÁRUKA

Pre tento nástroj platí zmluvná záruka na všetky výrobné a materiálové chyby od dátumu predaja užívateľovi a na základe predloženia pokladničného bloku. Záruka spočíva vo výmene chybných častí. Táto záruka neplatí v prípade použitia prístroja, ktoré nezodpovedá normám, ani v prípade škôd spôsobených nepovolenými zásahmi alebo nedbalosťou zo strany kupujúceho. Záruka sa nevzťahuje na škody spôsobené poruchou nástroja

HE. אחריות

הצגת השבנית קופה. האחריות-משמעה בחומר, החל מיום המכירה ומשמש על ידי התערבותו תללא הי עלכל זה חלה מתאים לתקנים ובמקרה של נזק שנגרם חלה במקרה של שימוש במכשיר שאינו החלף תחלקם הלקויים אחריות זו אינה חלה על נזק שנגרם על ידי תקלה בכלי. ידי רשלנות מאת הקונה. האחריות אינה עומדת או על

AR. الضمان

وبناء على مجرد تقديم بطاقة الشراء في تاريخ من تاريخ البيع الى المشتري عمل من أي غير فسي التصدي عوفي الجوال. إن هذه العدة مضمونة في حالة تعرضه قبلًا للتطبي في حالة الاستخدام غير سبب الارتفاع في الارتفاع في الارتفاع في الارتفاع من قبل المشتري في تطبيق الضمان عن عمليات تدخل غير حرجية أو في حالة

HU. GARANCIA

Erre a szerszáma szerződéses garanciát vállalunk bármilyen gyártási és anyaghibá felmerülése esetére, a fogyasztó részére történt eladás napjától számítva, a pénztári blokk egyzeredj felmutatása ellenében. A garancia a hibás alkatrészek cserejére terjed ki. Ez a garancia nem érvényes, ha a készüléket nem rendeltetésszerűen használták, sem illetéktelen beavatkozások, vagy a vásárló hanyagsága okozta károk eseten. A garancia nem fedezi azokat a károkat, melyeket a szerszám hibás működése okozott.

SL. GARANCIJA

To orodje je z garancijsko pogodbo zasciteno proti vsem napakam v izdelavi in v sestavnem materialu od datuma prodaje naprej in ta velja ob predložitvi blagajniškega računa. Garancija velja za zamenjavo delov z napako. Ta garancija ne velja za uporabo orodja, ki ni v skladu z normami, predpisanimi za omenjeno orodje in za primere okvar, ki nastanejo zaradi nedovoljenih posegov na orodju ali zaradi malomarnega rokovanja kupca. Garancija ne velja za škodo, ki jo lahko povzroči okvara orodja.

ET. GARANTII

See tööriist kuulub lepingu järgi

garantiiremonti arvestades alates müümise päevast ja kassatseki alusel kasutajale kõigi konstruktsiooni- ja materjalvigade puhul. Garantii seisneb defektsete osade väljavahetamises. See garantii ei kehti aparaadi normide ebatavalise eiramise puhul ega ostja poolt keelatud viisil kasutamisesest või hooletussejätmisest tulenevate kahjude korral. Garantii ei kehti seadme defektidest põhjustatud kahjude puhul

LV. GARANTIJA

Sis prietaisys yra užtikrinamas kaip itin geros kokybės, nuo jo panaudojimo, ir jam yra suteikiamas garantinis talonas. Garantijos metu galima pakeisti atsiradusius trumplaikinius gedimus. Si garantija netaikoma esant netinkamam naudojimui ar nesilaikant reikiam šio aparato, vartojimo instrukcijų, tai pat paciam pirkejuji jį sugadinus. Garantija taip pat netaikoma, prietaisą naudojant ne pagal paskirtį ir jį apgadinus

LT. GARANTIJA

Sim darbarikam ir ligumá noteikta garantija visiem defektiem, kas saistás ar konstrukciju un materiálu, sákot ar pardošanas datumá, kad mašinu pãrdot lietotájam un vienkarši uzrãdot kases ceku. Garantija ieklauj bojãto dalu nomainu. Si garantija nav derīga, ja aparãts nav lietots saskaņá ar drošibas noteikumiem, ne gadijumsos ja bojájumi radusies nesankcionētas iejauksãnas gadījumá vai arī pircēja nolaidības dēļ. Garantija nav derīga, ja bojájumi radusies darbariká defekta dēļ

HR. JAMSTVO

Ovaj alat ima ugovorno jamstvo u slucaju bilo kakvih nedostataka u konstrukciji i materijalu, od datuma prodaje korisniku uz jednostavno predocenje racuna. Jamstvo se sastoji u zamjeni neispravnih dijelova. Ovo se jamstvo ne primjenjuje u slucaju uporabe i eksploatacije koja nije sukladna standardima uređaja, niti u slucaju štete uzrokovane neovlastenim intervencijama ili nemarom kupca. Jamstvo se ne primjenjuje na štetu uzrokovanu nekim nedostatkom alata.

SERVICE APRÈS VENTE - AFTER SALE SERVICE

FAR GROUP EUROPE

Une société du groupe **SIGMA**

192, Avenue Yves Farge
37700 St. Pierre-des-Corps
FRANCE

www.fartools.com

