

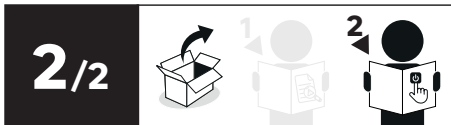

Ipanema

EAN CODE: 3276007464535

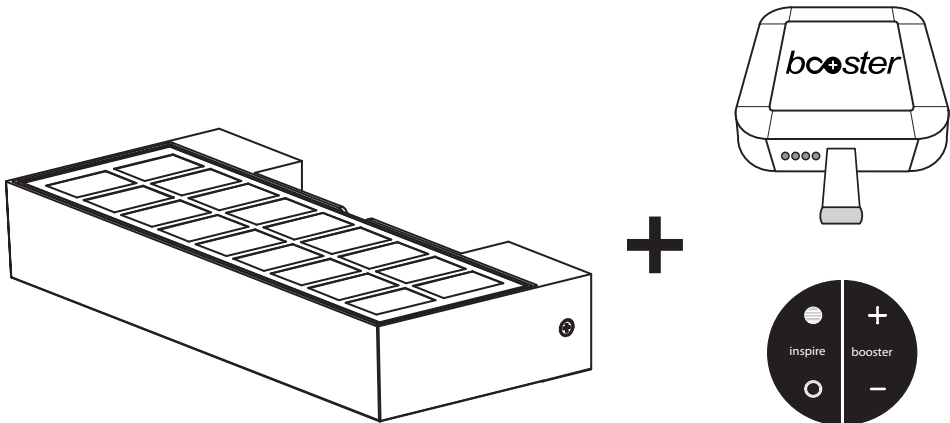

2022/03 V02

**FR** Manuel d'Instructions

**ES** Manual de Instrucciones

**PT** Manual de Instruções

**IT** Manuale di Istruzioni

**EL** Εγχειρίδιο Οδηγιών

**PL** Instrukcja Obsługi

**UA** Інструкція ЗЕксплуатації

**RO** Manual de Instrucțiuni

**EN** Instructions Manual

\* Garantie 3 ans / 3 años de garantía / Garantia de 3 anos / Garanzia 3 Anni / Εγγύηση 3 ετών / Gwarancja 3-letnia / Гарантія 3 років / Garanție 3 ani / Garantia de 3 anos / 3-year-guarantee

\*\* réparable / repairable / reparável / riparabile / διορθώσιμος / naprawiany / ремонтний / reparabil / repairable



Montage / Montaje / Montagem / Montaggio / Συναρμολόγηση / Montaż / Збірка / Montaj /  
Assembly



2 → 5



Utilisation / Utilización / Utilização / Uso / Χρήση / Użytkowanie /  
Використання / Utilizare / Use



6 → 10



1/2



FR : CARACTERISTIQUES TECHNIQUES / ES : CARACTERÍSTICAS TÉCNICAS / PT : CARACTERÍSTICAS TÉCNICAS /  
IT : CARATTERISTICHE TECNICHE / EL : ΤΕΧΝΙΚΑ ΧΑΡΑΚΤΗΡΙΣΤΙΚΑ / PL : DANE TECHNICZNE / UA : ТЕХНІЧНІ ХАРАКТЕРИКИ  
/ RO : CARACTERISTI TECHICE / BR : CARACTERÍSTICAS TÉCNICAS / EN : TECHNICAL CHARACTERISTICS



1



4



6

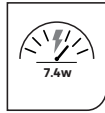

9



12

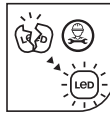

19

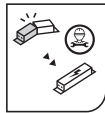

20

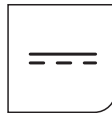

31



34



35

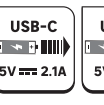
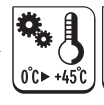
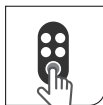



A

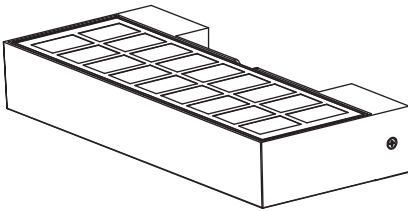

B



C

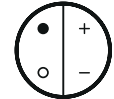

+

+

+

D

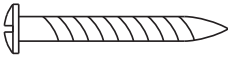
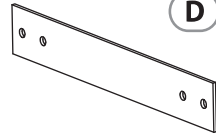

E x4

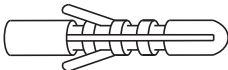

F x4



G x1

CR2032

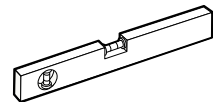

⊕ PZ

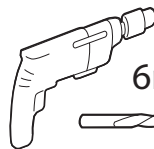
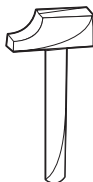

6mm





1

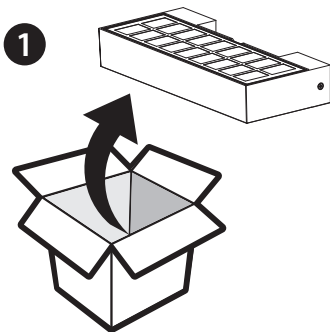

2

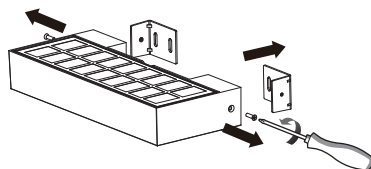

3

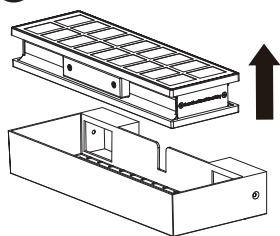

4

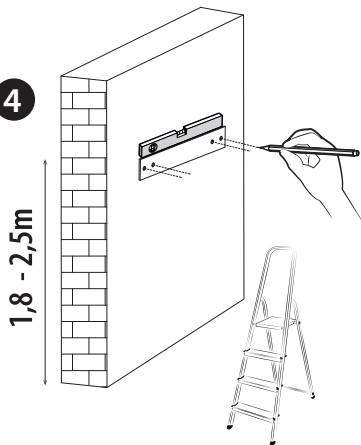

2

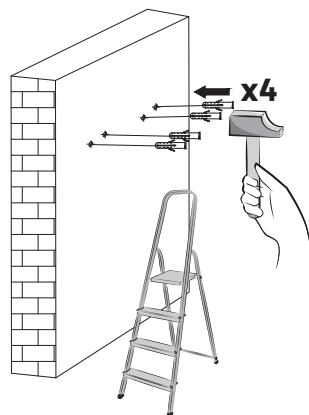
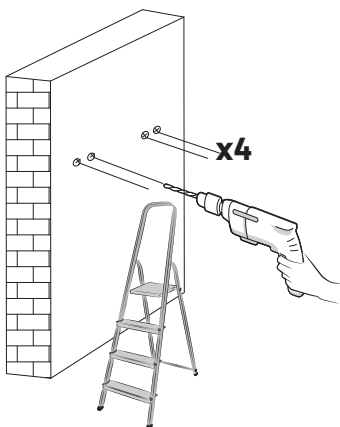

3

# 3

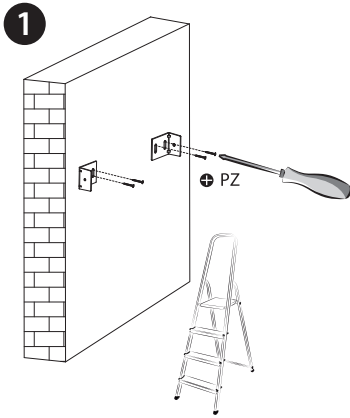

**2**

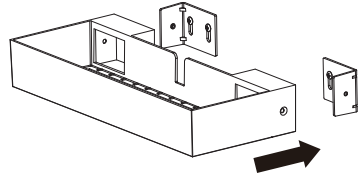

**3**

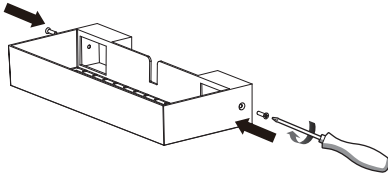

**4**

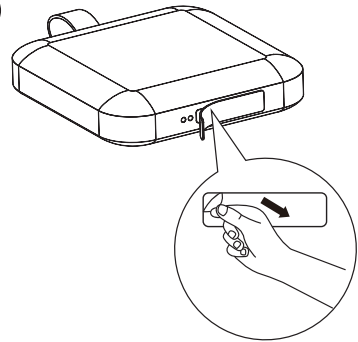

# 4

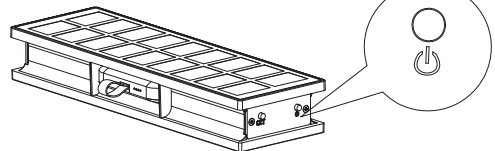
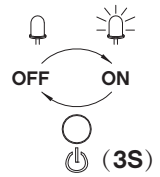
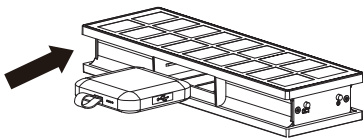

5

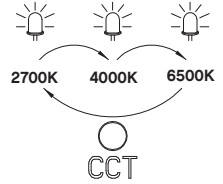
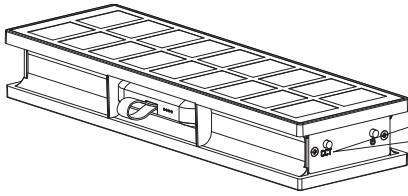

6

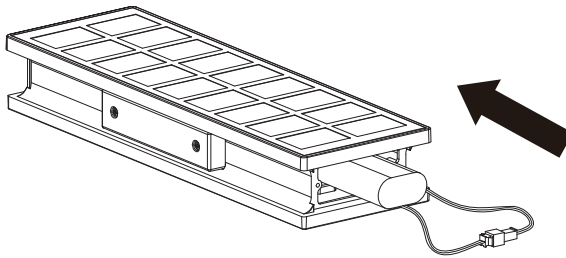

7

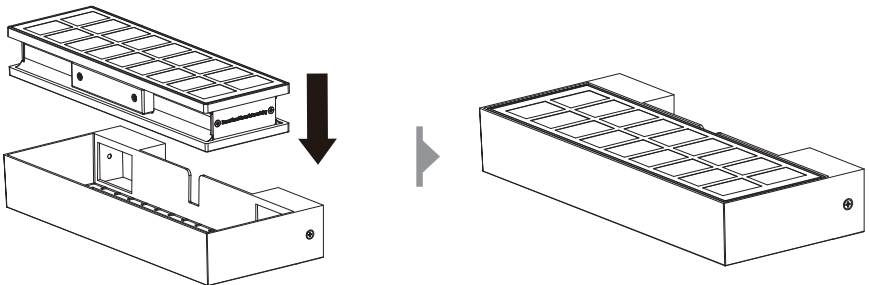



1

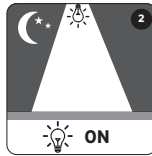
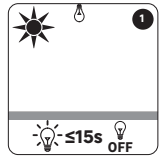
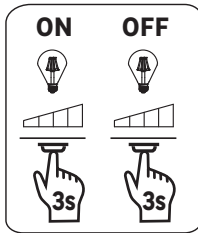
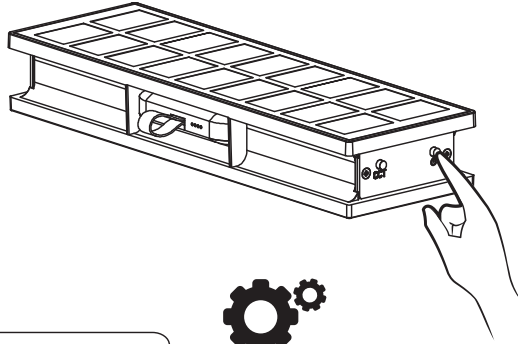

# 2

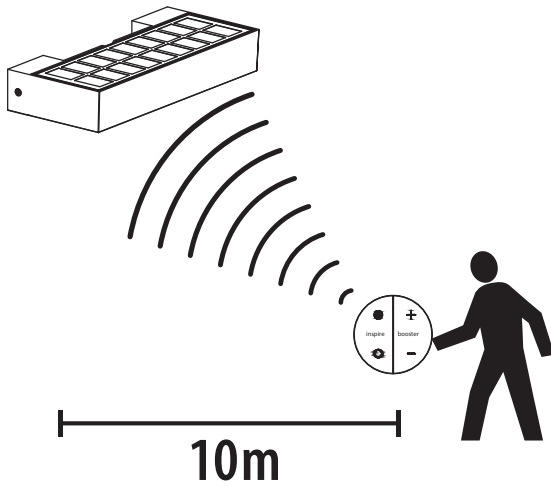
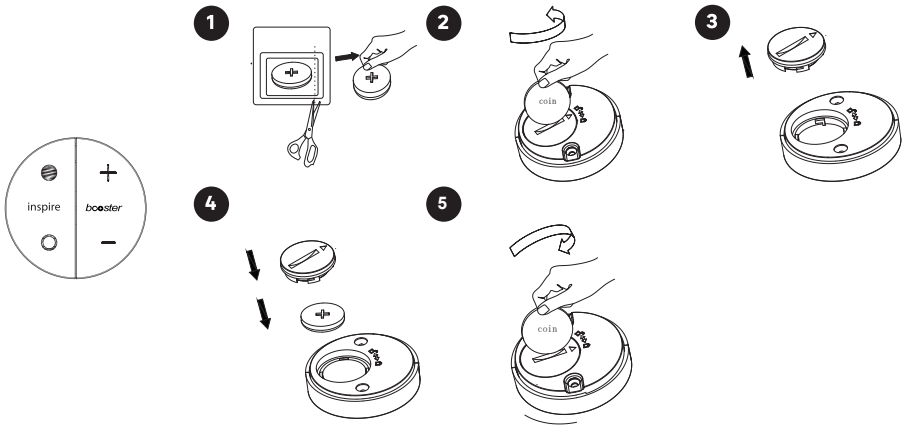



# 3

**booster**

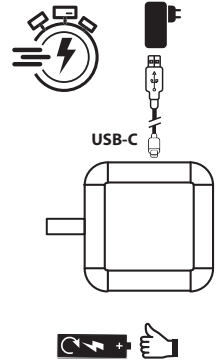
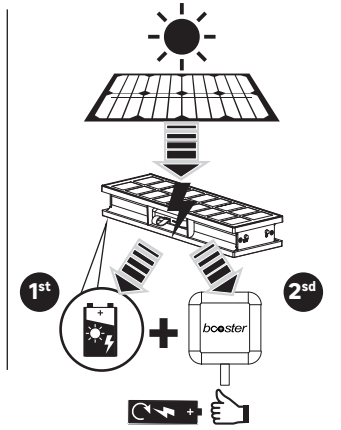
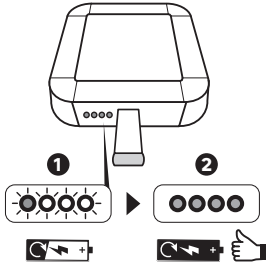

# 4

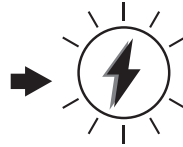
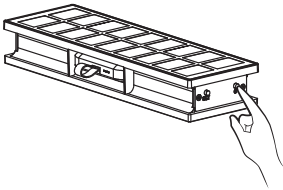

>7s

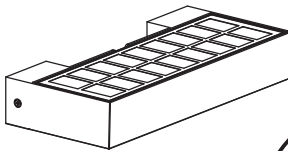

=

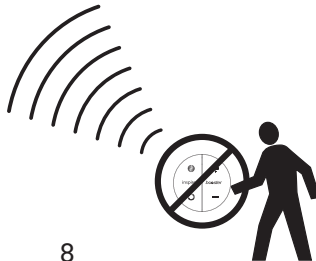

# 5



1

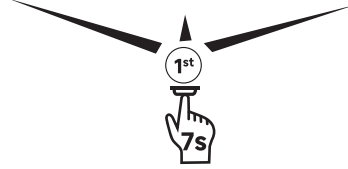
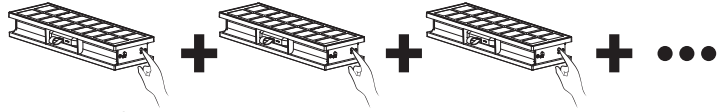

2

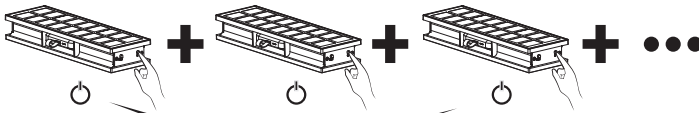

<30s

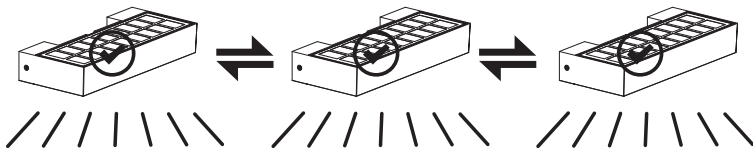
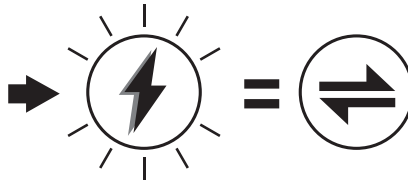
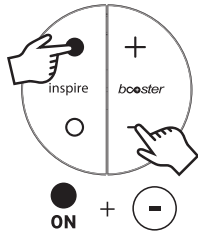

# 6

## Twilight Sensing

flash 2 times

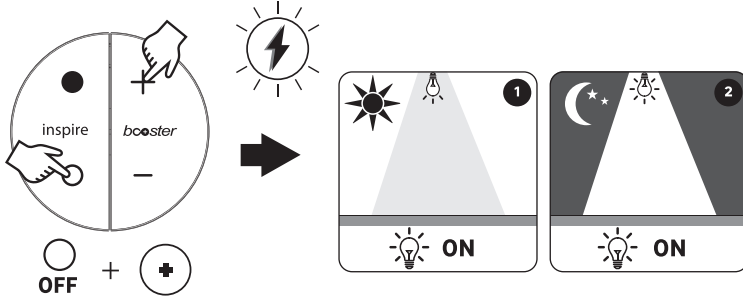

flash 2 times

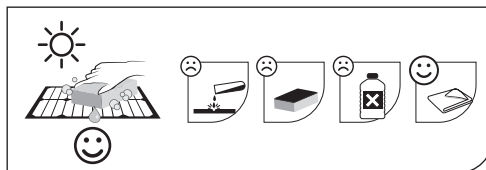
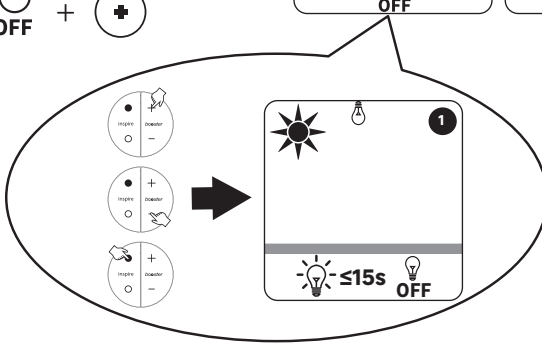
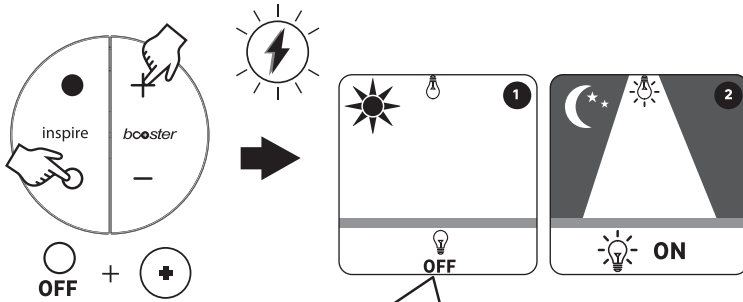



Made in China

Traduction de la version originale du mode d'emploi / Traducción de las Instrucciones originales / Tradução das Instruções Originais / Traduzione delle istruzioni originali / Μετάφραση των πρωτότυπων οδηγιών / Тітмацнені інструкції оригіналеї / Переклад оригінальної інструкції / Traducerea instrucțiunilor originale / Tradução das Instruções Originais / Original Instructions

---

### ADEO Services - 135 Rue Sadi Carnot - CS 00001 - 59790 RONCHIN - France

**UA** Виробник: ТОВ "Адео Сервісез С.А.", вул. Саді Карно, CS 00001, 59790 Роншен, Франція.  
Імпортер: ТОВ "Леруа Мерлен Україна", 04201 Україна, м.Київ, вул. Полярна 17А, +380 44 498 46 00.  
Імпортер приймає претензії від споживачів щодо товару, а також проводить його еремент, технічне і гарантійне обслуговуваня

**BR** IMPORTADO E DISTRIBUÍDO POR:  
LEROY MERLIN COMPANHIA BRASILEIRA DE BRICOLAGEM CNPJ: 01.438.784/0001-05  
Rua Pascoal Pais, nº. 525, 6º andar, cj 61 a 64 - Vila Cordeiro, São Paulo - SP CEP: 04581-060  
CALM (Central de Atendimento Leroy Merlin)  
Capitais 4020-5376 Demais Regiões 0800-0205376  
IMAGEM ILUSTRATIVA

**ZA** Imported by Adeo South Africa (PTY) LTD T/A Leroy Merlin  
Leroy Merlin Greenstone Store Corner Blackrock Street and Stoneridge Drive, Greenstone Park Ext 2, Edenvale, 1610 Johannesburg, Gauteng, South Africa