

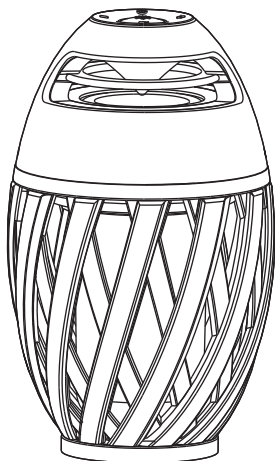

Isken

EAN : 3276007468830



2/2



2022-07-V01

**FR** Manuel d'Instructions

**ES** Manual de Instrucciones

**PT** Manual de Instruções

**IT** Manuale di Istruzioni

**EL** Εγχειρίδιο Οδηγιών

**PL** Instrukcja Obsługi

**UA** Інструкція з Експлуатації

**RO** Manual de Instrucțiuni

**DE** Anleitung Handbuch

**EN** Instructions Manual

\*Année de garantie / años de garantía / Ano de garantía / Anno di garanzia / Έτος εγγύησης / Rok gwarancji / Гарантія років / Anul de garanție / Año de garantía / Jahr der Garantie / Year of guarantee

\*\* réparable / reparabile / reparável / riparabile / διορθώσιμος / naprawiany / ремонтний / reparabil / reparaturfähig / repairable





Montage / Montaje / Montagem / Montaggio / Συναρμολόγηση / Montaž / Збірка /  
Montaj / Assembly



3



Utilisation / Utilización / Utilização / Uso / Χρήση / Użytkowanie /  
Використання / Utilizare / Use



4 → 9

FR: CARACTERISTIQUES TECHNIQUES / ES: CARACTERÍSTICAS TÉCNICAS / PT: CARACTERÍSTICAS TÉCNICAS / IT: CARATTERIS-  
TICHE TECNICHE / EL: ΤΕΧΝΙΚΑ ΧΑΡΑΚΤΗΡΙΣΤΙΚΑ / PL: DANE TECHNICZNE / UA: / RO: CARACTERISTI TECHICE / DE: TECHNISCHE  
MERKMALE / EN: TECHNICAL CHARACTERISTICS



1 / 2



1



4



6



8



9



12



8h-22h  
MAX\*\*



22



23



31



34

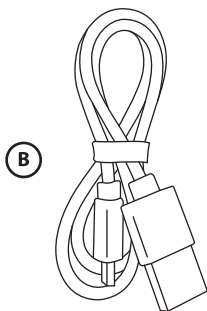
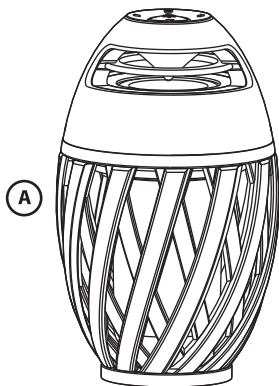



1

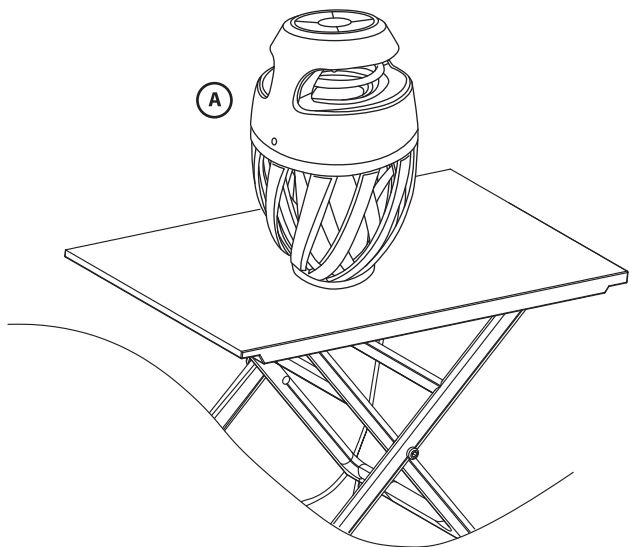



1

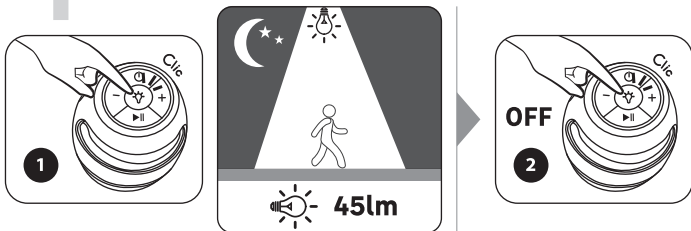

2

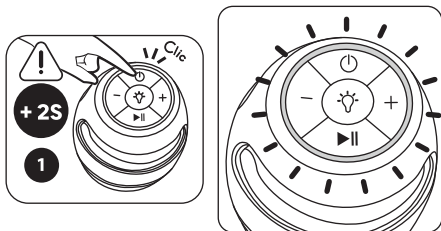

ISKEN-INSPIRE

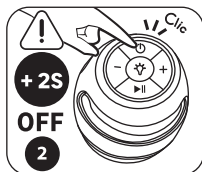

# 3

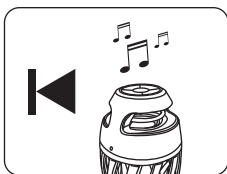
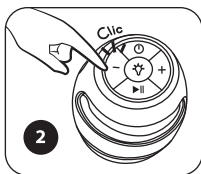
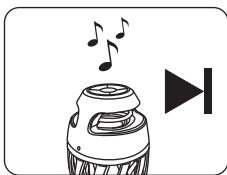
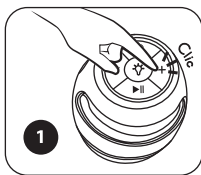

# 4

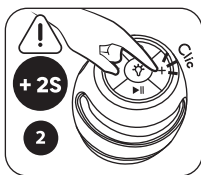
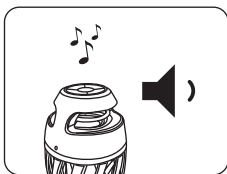
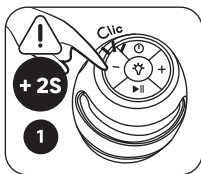

# 5

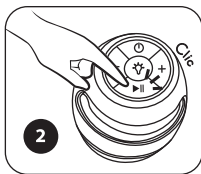
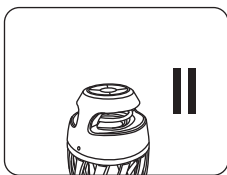
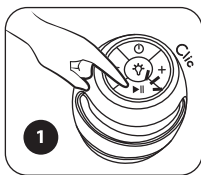

# 6

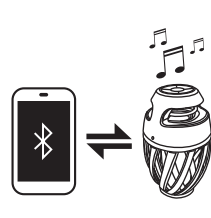
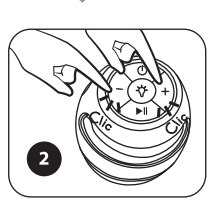
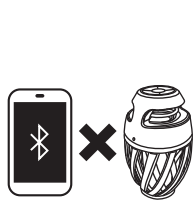
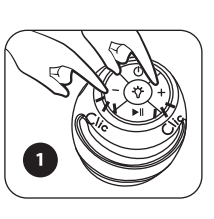
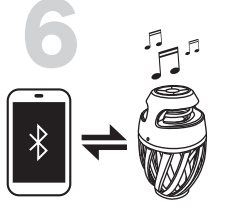



# 7

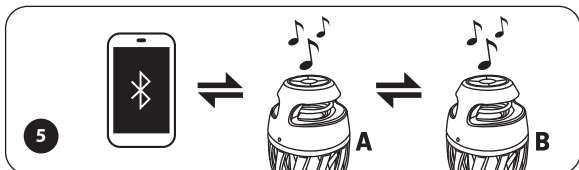
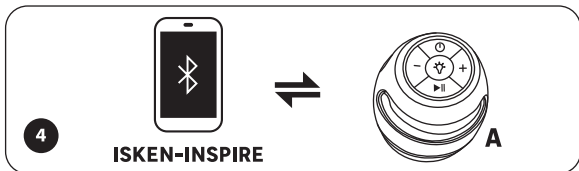
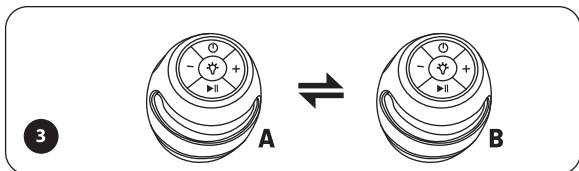
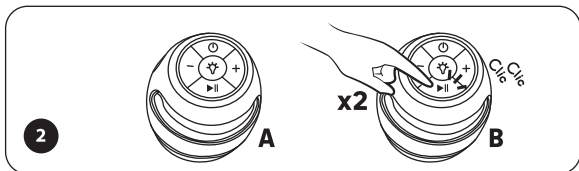
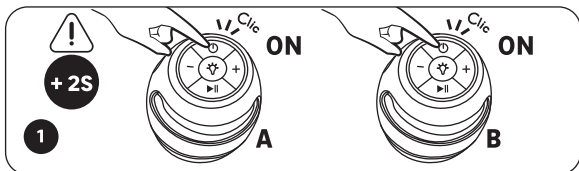

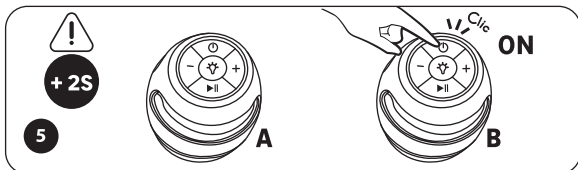
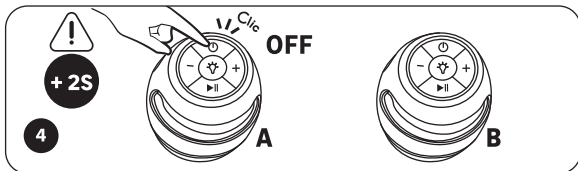
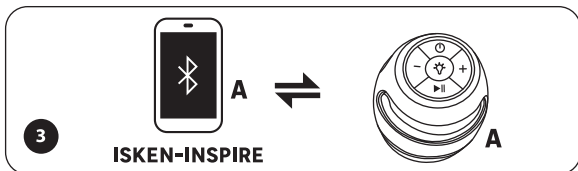
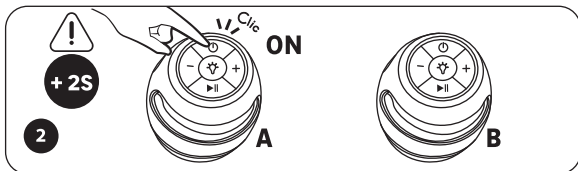
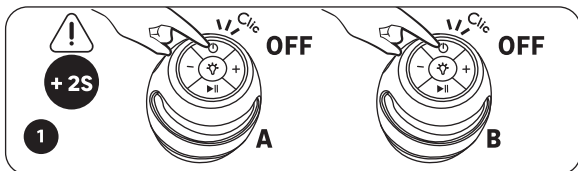

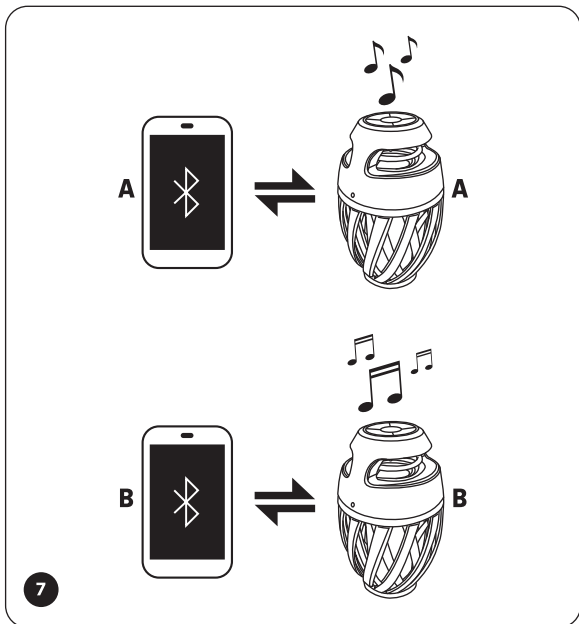
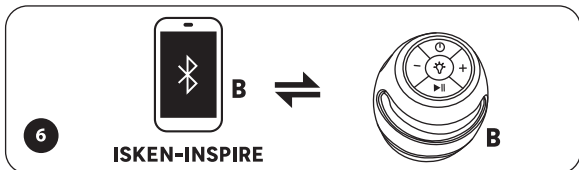

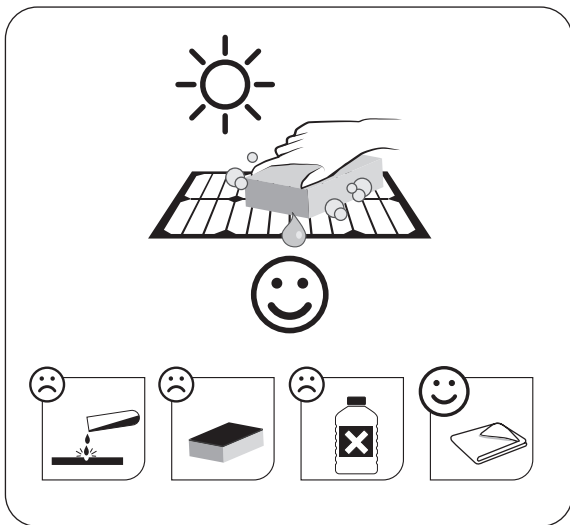
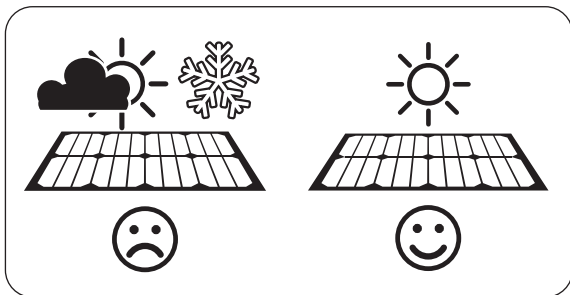





EU/EC Declaration of conformity  
Déclaration UE/CE de conformité  
DECLARACIÓN CE / UE DE CONFORMIDAD  
Declaração CE/UE de conformidade



ENFR  
ESP1

Product Model/Modèle du produit/Modelo de producto/Modelo do produto

84723581

Name and address of the manufacturer or his authorised representative/Nom et adresse du fabricant ou de son mandataire/Nome y dirección del fabricante o de su representante autorizado/Nome e endereço do fabricante ou do seu representante autorizado

ADEO Services, 135 Rue Sadi Carnot - CS 00001 59790 RONCHIN - France

This declaration of conformity is issued under the sole responsibility of the manufacturer./La présente déclaration de conformité est établie sous la seule responsabilité du fabricant./La presente declaración de conformidad se expide bajo la exclusiva responsabilidad del fabricante./Esta declaração de conformidade é emitida sob a exclusiva responsabilidade do fabricante./

Object of the declaration/Objet de la déclaration/Objeto de la declaración/Objeto da declaração

Product Type - Descriptor/Type de produit - Description/Tipo de producto - MOBILE LIGHT USB SPEAKER 45LM FLAME EFF 16,5CM PC IP54 INSPIRE ISKEN

Product Reference/Referéncia produit/Referéncia del producto/Referéncia do produto 84723581 - EAN Code: 3276007468830 Industrial Type Design Reference: ISKENNG113

Product Brand/ Marque Produit/Producto de marca/ Marca do produto INSPIRE

Serial number coding or batch number/Codification du numéro de série ou de lot/Codificação del número de serie/Codificação do número de série NNNNNN-DDMMYYYY-DD (NNNNNN : the last 6 digits of the EAN code, DDDMMYYYY : The date on which the order is created in the factory, DD : number of order

The object of the declaration described above is in conformity with the relevant Union harmonization legislation./L'objet de la déclaration décrit ci-dessus est conforme à la législation d'harmonisation de l'Union applicable./El objeto de la declaración descrita anteriormente es conforme a la legislación de armonización pertinente de la Unión/O objeto da declaração acima descrita está em conformidade com a legislação de harmonização da União aplicável./

References to the relevant harmonised standards used or references to the specifications in relation to which conformity is declared/Referéncias des normes harmonisées pertinentes auxquelles ou des spécifications par rapport auxquelles la conformité est déclarée/Referencias a las normas armonizadas pertinentes utilizadas, o referencias a las especificaciones respecto a las cuales se declara la conformidad/Referéncias às normas harmonizadas pertinentes utilizadas ou referéncias às especificações para as quais a conformidade é declarada./

When applicable, the name and number of notified body number./Le cas échéant, le nom et le numéro de l'organisme notifié./Cuando correspondo, el nombre y número de laboratorio notificado que haya emitido la certificación y la referencia al documento./Quando aplicável, o nome e número do laboratório notificado que emitiu a certificação e a referência ao documento./

EN 62368-1:2014 + A11:2017  
EN IEC 59015:2019 + A11:2020  
EN IEC 61000-3-2:2019 + A1:2021  
EN 61000-3-3:2013 + A1:2019 + A2:2021  
EN 61527:2009  
EN 60998-2-4:2019  
ETSI EN 300 328 V2.2.2 (2019-07)  
ETSI EN 301 488-1 V2.2.3 (2019-11)  
ETSI EN 301 488-17 V3.2.4 (2020-09)  
EN 60032:2019/A11:2020  
EN 55035:2017/A11:2020  
EN 62479:2019  
EN 60965:2017

2014\_53\_EU\_RED  
radio equipment / Equipements radioélectriques/equipos radioelétricos/equipamentos de rádio

RoHS Directive (EU)2015/863 amending Directive 2011/65/EU  
EN 62311-2:2014  
EN 62311-3-1:2014  
EN 62311-4:2014/A1:2017  
EN 62311-5:2015  
EN 62311-6:2015  
EN 62311-7-1:2015  
EN 62311-7-2:2017  
EN 62311-8:2017  
EN IEC 63000:2018

2011\_65\_EU\_RoHS  
Restriction of hazardous substances in electrical products/Restriction des substances dangereuses dans les produits électriques/Restricción de sustancias peligrosas en equipos eléctricos/Restricção de substâncias perigosas em equipamentos elétricos

Completed, signed by and on behalf of/Complé, signé par et au nom de/Completado, firmado por y en nombre de/Completado, assinado por e em nome de

Eric LEMONE  
International Project Quality Leader

ADEO Services SAS  
135 Rue Sadi Carnot  
59790 Ronchin  
France

Place and date of issue/Lieu et date d'émission/Lugar y fecha de expedición/Local e data de emissão  
Ronchin France  
11/10/2022





- FR** Ce produit est recyclable. S'il ne peut plus être utilisé, veuillez l'apporter dans un centre de recyclage de déchets.
- ES** Este producto es reciclable. Si ya no se puede usar, llévelo a un centro de reciclaje de residuos.
- PT** Este produto é reciclável. Se deixar de o utilizar, entregue-o num centro de reciclagem de resíduos.
- IT** Questo prodotto può essere riciclato. Se deve essere smaltito, portalo presso un centro di riciclaggio.
- EL** Αυτό το προϊόν είναι ανακυκλώσιμο. Εάν δεν μπορεί πλέον να χρησιμοποιηθεί, μεταφέρετε την σε κάποιο κέντρο ανακύκλωσης απορριμμάτων.
- PL** Ten produkt poddawany jest recyklingowi, kiedy przestaje być użyteczny należy dostarczyć go do punktu zbiórki odpadów.
- UA** Цей продукт може перероблятися. Якщо воно більше не є придатне для використання, здайте його в утилізаційний центр.
- RO** Acest produs este reciclabil. Dacă nu mai poate fi folosit, vă rugăm să îl aduceți într-un centru de reciclare a deșeurilor.
- BR** Este produto é reciclável. Se não puder mais ser usado, descarte em um centro de reciclagem de resíduos.
- DE** Dieses Produkt ist recycelbar. Wenn es nicht mehr verwendet werden kann, bringen Sie es bitte zum Recycling-Center.
- EN** This product is recyclable. If it cannot be used anymore, please take it to waste recycling centre.



Traduction de la version originale du mode d'emploi / Traducción de las Instrucciones originales / Tradução das Instruções Originais / Traduzione delle istruzioni originali / Μετάφραση των πρωτότυπων οδηγιών / Tłumaczenie instrukcji oryginalnej / Переклад оригінальної інструкції / Traduce re-a instrucțiunilor originale / Tradução das Instruções Originais / Original-Anleitung / Original Instructions.

Made in China  
Країна походження: Китай

**EU** ADEO Services - 135 Rue Sadi Carnot - CS00001 - 59790 RONCHIN - FRANCE

**UA** ТОВ «Адео Сервісез С.А.», вул. Саді Карно, CS 00001, 59790 Роншен, Франція.

**ZA** Imported by Adeo South Africa (PTY) LTD T/A Leroy Merlin, Hosted in Leroy Merlin Fourways Store 35 Roos Street, Witkoppen Ext 97, Sandton, 2191 Johannesburg, Gauteng, South Africa. Tel: +27 10 493 8000 Email: contact@leroymerlin.co.za.

**BR** IMPORTADO E DISTRIBUÍDO POR: LEROY MERLIN  
COMPANHIA BRASILEIRA DE BRICOLAGEM CNPJ:  
01.438.784/0001-05 Rua Pascoal Pais, nº. 525, 6º andar,  
cj 61 a 64 - Vila Cordeiro, São Paulo - SP CEP: 04581-060  
CALM (Central de Atendimento Leroy Merlin) Capitais  
4020-5376 Demais Regiões 0800-0205376