

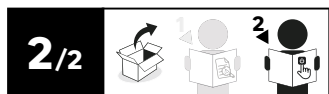

EAN : 3276007574425
REF : 85686407

EAN : 3276007574432
REF : 85686408



- FR Manuel d'Instructions
- EL Εγχειρίδιο Οδηγιών
- DE Anleitung Handbuch
- ES Manual de Instrucciones
- PL Instrukcja Obsługi
- EN Instructions Manual
- PT Manual de Instruções
- UA Інструкція з Експлуатації
- IT Manuale di Istruzioni
- RO Manual de Instrucțiuni

*Année de garantie / años de garantía / Ano de garantia / Anno di garanzia / Έτος εγγύησης / Rok gwarancji / Гарантія років / Anul de garanție / Ano de garantía / Jahr der Garantie / Year of guarantee
** réparable / repairable / reparável / riparabile / βιορθώσιμος / naprawiany / ремонтний / reparabil / reparaturfähig / repairable



Montage / Montaje / Montagem / Montaggio / Συναρμολόγηση / Montaž / Збірка / Ansamblu / Montaje / Montage / Assembly



Utilisation / Utilizaci3n / Utiliza3o / Uso / Χρήση / Uzytkowanie / Використовуйте / Utilizați / Utilizare / Verwenden Sie / Use



FR : CARACTERISTIQUES TECHNIQUES / ES : CARACTERÍSTICAS TÉCNICAS / PT : CARACTERÍSTICAS TÉCNICAS / IT : CARATTERISTICHE TECNICHE / EL : ΤΕΧΝΙΚΑ ΧΑΡΑΚΤΗΡΙΣΤΙΚΑ / PL : DANE TECHNICZNE / UA : ТЕХНІЧНІ ХАРАКТЕРИКИ / RO : CARACTERISTI TEHNICE / DE : TECHNISCHE MERKMALE / EN : TECHNICAL CHARACTERISTICS

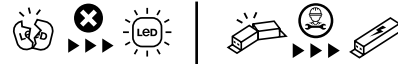
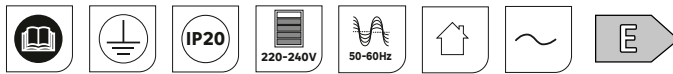

- FR Ce produit contient une source lumineuse de classe d'efficacité énergétique E .
- ES Este producto contiene una bombilla de clase de eficiencia E .
- PT Este produto contém uma fonte de luz de eficiência energética de classe E .
- IT Questo prodotto contiene una sorgente luminosa di classe di efficienza energetica E .
- EL Αυτό το προϊόν περιέχει πηγή φωτός κατηγορίας ενεργειακής απόδοσης E .
- PL Niniejszy produkt zawiera źródło światła klasy efektywności energetycznej E .
- UA Данне изделие содержит источник света класса энергоэффективности E .
- RO Acest produs con ine o sursă de lumină din clasa de eficiență energetică E .
- BR Este produto inclui uma luz da classe de eficiência energética E .
- DE Dieses Produkt umfasst eine Leuchte der Energieeffizienz-Klasse E .
- EN This product includes a light of the energy efficiency class E .

Importado e distribuído por: LEROY MERLIN COMPANHIA BRASILEIRA DE AÇO, S/A - Rua Santa Cruz, 155 - Vila Cordero, São Paulo - SP CEP: 04581-060 - Brasil
Importado e distribuído por: LEROY MERLIN COMPANHIA BRASILEIRA DE AÇO, S/A - Rua Santa Cruz, 155 - Vila Cordero, São Paulo - SP CEP: 04581-060 - Brasil
Importado e distribuído por: LEROY MERLIN COMPANHIA BRASILEIRA DE AÇO, S/A - Rua Santa Cruz, 155 - Vila Cordero, São Paulo - SP CEP: 04581-060 - Brasil
Importado e distribuído por: LEROY MERLIN COMPANHIA BRASILEIRA DE AÇO, S/A - Rua Santa Cruz, 155 - Vila Cordero, São Paulo - SP CEP: 04581-060 - Brasil
Importado e distribuído por: LEROY MERLIN COMPANHIA BRASILEIRA DE AÇO, S/A - Rua Santa Cruz, 155 - Vila Cordero, São Paulo - SP CEP: 04581-060 - Brasil
Importado e distribuído por: LEROY MERLIN COMPANHIA BRASILEIRA DE AÇO, S/A - Rua Santa Cruz, 155 - Vila Cordero, São Paulo - SP CEP: 04581-060 - Brasil
Importado e distribuído por: LEROY MERLIN COMPANHIA BRASILEIRA DE AÇO, S/A - Rua Santa Cruz, 155 - Vila Cordero, São Paulo - SP CEP: 04581-060 - Brasil
Importado e distribuído por: LEROY MERLIN COMPANHIA BRASILEIRA DE AÇO, S/A - Rua Santa Cruz, 155 - Vila Cordero, São Paulo - SP CEP: 04581-060 - Brasil
Importado e distribuído por: LEROY MERLIN COMPANHIA BRASILEIRA DE AÇO, S/A - Rua Santa Cruz, 155 - Vila Cordero, São Paulo - SP CEP: 04581-060 - Brasil
Importado e distribuído por: LEROY MERLIN COMPANHIA BRASILEIRA DE AÇO, S/A - Rua Santa Cruz, 155 - Vila Cordero, São Paulo - SP CEP: 04581-060 - Brasil

Made in China
Traduction de la version originale du mode d'emploi / Traducción de las instrucciones originales / Traduzione delle istruzioni originali / Μετάφραση των οδηγιών / Переклад оригінальних інструкцій / Traducere a versiunii originale a instrucțiunilor / Original instructions



- FR Ce produit est recyclable. S'il ne peut plus être utilisé, veuillez l'apporter dans un centre de recyclage de déchets.
- ES Este producto es reciclable. Si ya no se puede usar, lleve-lo a un centro de reciclaje de residuos.
- PT Este produto é reciclável. Se não puder mais ser usado, descarte-o num centro de reciclagem de resíduos.
- IT Questo prodotto è riciclabile. Se non può essere più utilizzato, portarlo presso un centro di riciclaggio.
- UA Це продукт є переробним. Якщо він більше не може бути використаний, зробіть його в утилізаційному центрі.
- RO Acest produs este reciclabil. Dacă nu mai poate fi folosit, vă rugăm să îl aduceți într-un centru de reciclare a deșeurilor.
- PL Ten produkt poddamy jest recyklingowi, kiedy przestaje być użyteczny należy dostarczyć go do punktu zbiórki odpadów.
- EN This product is recyclable. If it cannot be used anymore, please take it to waste recycling centre.



A x1

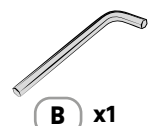

B x1

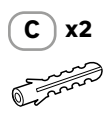

C x2

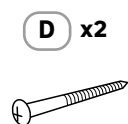

D x2

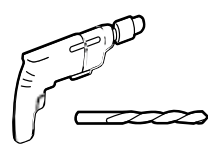

Ø 5 mm

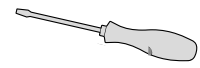

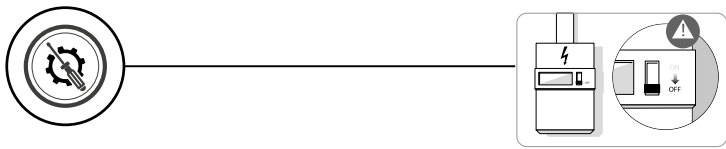

1



2

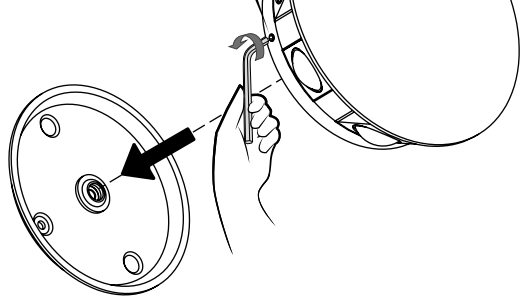

2

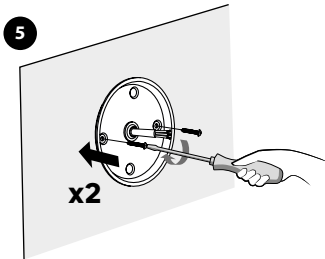
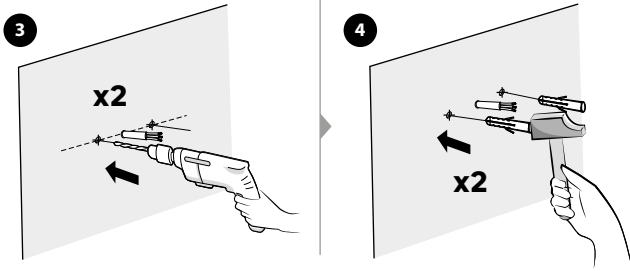
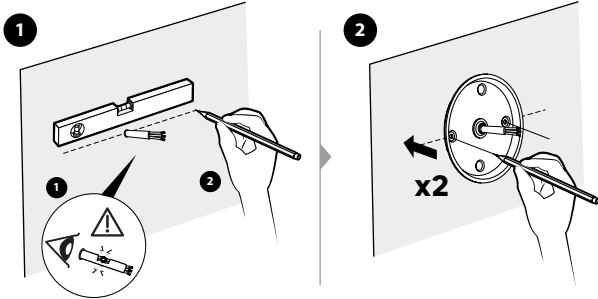

Utiliser des vis et des chevilles adaptées à votre support / Utilice tacos y tornillos adecuados al soporte / Utilize buchas e parafusos adequado ao seu suporte / Utilizzare viti e tasselli adatti per il retro / Χρησιμοποιήστε βίδες και βύσματα που ταιριάζουν στην επιφάνεια στήριξης. / Należy użyć śrub i kotków odpowiednich dla podłoża / Використовуйте гвинти та шканти, призначені для задньої поверхні. / Utilizați șuruburi și dibluri adecvate pentru suportul dvs. / Use parafusos e buchas adequados para seu suporte / Verwenden Sie für Ihre Unterlage geeignete Schrauben und Dübel / Use screws and dowels suited to your backing

3

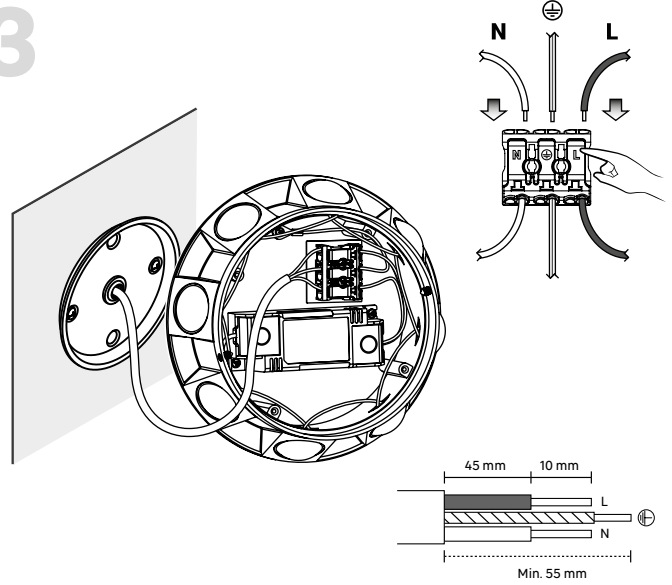

N =Bleu/Azul/Azul/Blu/Μπλε/Niebieski/Синій/Albastru/Blau/**Blue**
 ⊕ =Vert et jaune/Verde y amarillo/Verde e giallo/
 Πράσινο και κίτρινο / Zielony i żółty / Зелений і жовтий/Verde-galben/
 Verde e amarelo/Grün und gelb/**Green and yellow**
 L =Marron/Marrón/Castanho/Marrone/Καφέ/Brązowy/
 Коричневий/Μαρο/Marrom/Braun/**Brown**

4

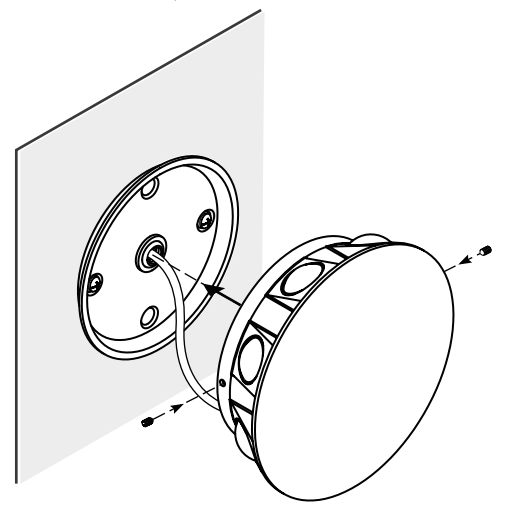

5

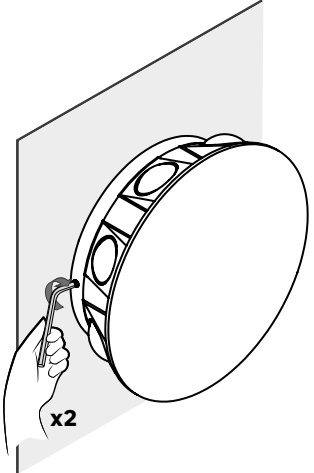

6

