

WORX

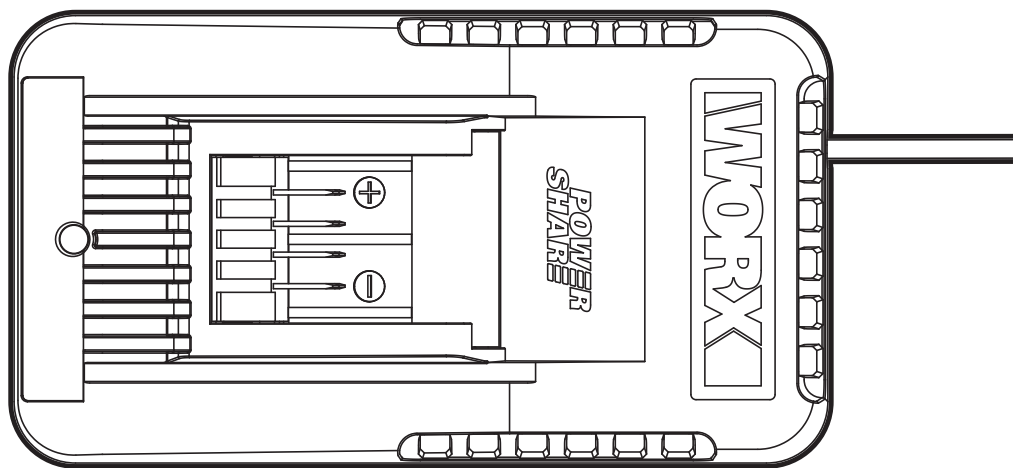

SAFETY AND OPERATING MANUAL

ORIGINAL INSTRUCTIONS

Battery Charger

WA3880







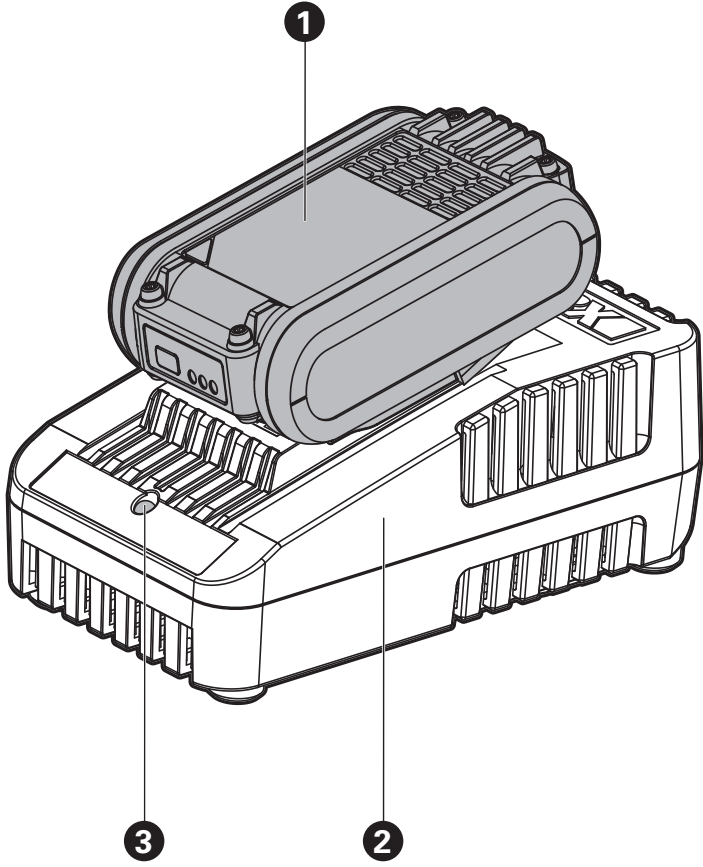

PRODUCT SAFETY GENERAL SAFETY WARNINGS

⚠ WARNING: Read all safety warnings and all instructions. *Failure to follow the warnings and instructions may result in electric shock, fire and/or serious injury.*

Save all warnings and instructions for future reference.

This appliance can be used by children aged from 8 years and above and persons with reduced physical, sensory or mental capabilities or lack of experience and knowledge if they have been given supervision or instruction concerning use of the appliance in a safe way and understand the hazards involved. Children shall not play with the appliance. Cleaning and user maintenance shall not be made by children without supervision.

This appliance is not intended for use by persons (including children) with reduced physical, sensory or mental capabilities, or lack of experience and









knowledge, unless they have been given supervision or instruction concerning use of the appliance by a person responsible for their safety. Children should be supervised to ensure that they do not play with the appliance. If the supply cord is damaged, it must be replaced by the manufacturer, its service agent or similarly qualified persons in order to avoid a hazard.

ADDITIONAL SAFETY INSTRUCTIONS FOR YOUR BATTERY CHARGER

1. Before charging, read the instructions.
2. Do not charge a leaking battery.
3. Do not use chargers for works other than those for which they are designed.
4. Before charging, ensure your charger is matching the local AC supply.
5. For indoor use, or do not expose to rain.
6. The charging device must be protected from moisture.
7. Do not use the charging device in the open.
8. Do not short out the contacts of battery or

- charger.
9. Respect the polarity "+/-" when charging.
 10. Do not open the unit and keep out of the reach of children.
 11. Do not charge the batteries of other manufactures or ill-suited models .
 12. Ensure that the connection between the battery charger and battery is correctly positioned and is not obstructed by foreign bodies.
 13. Keep battery charger's slots are free of foreign objects and protect against dirt and humidity. Store in a dry and frost-free place.
 14. When charging batteries, ensure that the battery charger is in a well-ventilated area and away from inflammable materials. Batteries can get hot during charging. Do not overcharge any batteries. Ensure that batteries and chargers are not left unsupervised during charging.
 15. Do not recharge non-rechargeable batteries, as they can overheat and break.
 16. Longer life and better performance can be obtained if the battery pack is charged when the air temperature is between 18°C and 24°C. Do not charge the battery pack in air temperatures below 0°C, or above 40°C. This is important as it can prevent serious damage to the battery pack.
 17. Charge only battery pack of the same model provided by Worx and of models recommended by Worx.
 18. For charge Li-ion battery pack only.

SYMBOLS

	Read the operator's manual.
	Warning
	For indoor use only
	Double insulation
	Fuse
	Positive terminal
	Negative terminal
	Waste electrical products must not be disposed of with household waste. Please recycle where facilities exist. Check with your local authorities or retailer for recycling advice.
	RCM marking

ABN: Australian Business Number. By this number, business information such as entity type, status, business location etc. can be found at website <http://abr.business.gov.au>.

ABN of Positec Australia Pty Limited is 14 101 682 357

1. BATTERY PACK *



2. CHARGER

3. CHARGE INDICATOR LIGHT

*** Not all the accessories illustrated or described are included in standard delivery.**

We recommend that you purchase your accessories listed in the above list from the same store that sold you the battery charger. Refer to the accessory packaging for further details. Store personnel can assist you and offer advice.

TECHNICAL DATA

Rated input voltage	100-240V~50/60Hz	
Output voltage	20V 	
Charging current	2A	
Rated Input power	50W	
Charge battery	Li-Ion	
Number of cells	4/5/10	
Charging time (approx.)		
Battery pack	-- 1.3Ah	42mins
	-- 1.5Ah	45mins
	-- 2.0Ah	58mins
	-- 2.5Ah	77mins
	-- 3.0Ah	95mins
	-- 4.0Ah	125mins
	-- 5.0Ah	145mins
	-- 6.0Ah	183mins
Protection class	 /II	
Machine weight	0.45kg	

For the technical data of the types, the number of cells and the rated capacity of the batteries that can be charged, please refer the nameplate of the battery pack supplied by Worx.

CHARGING PROCEDURE

 **NOTE:** Before using the tool, read the instruction book carefully.

CHARGING INSTRUCTIONS

1. CHARGING YOUR BATTERY PACK

 **WARNING:** The charger and battery pack are specifically designed to work together so do not attempt to use any other devices. Never insert or allow metallic objects into your charger or battery pack connections because an electrical failure and hazard will occur.

2. BEFORE USING YOUR CORDLESS TOOL

Your battery pack is UNCHARGED and you must charge once before use.



3. HOW TO CHARGE YOUR BATTERY CHARGING PROCEDURE



- 1) Plug the charger into an appropriate outlet.
- 2) Slide the battery pack into the charger. The LIGHT (3) will become green and flash to show charging has started.
- 3) After charging approx 1-2 hours, the light will stay green without flashing, which means the battery is full, and charging is completed.

 **WARNING:** When battery charge runs out after continuous use or exposure to direct sunlight or heat, allow time for the battery to cool down before re-charging to achieve the full charge.

CHARGING INDICATOR

This charger is designed to detect some problems that can arise with battery packs. Indicator lights indicate problems (see table below). If this occurs, insert a new battery pack to determine if the charger is OK. If the new battery charges correctly, then the original pack is defective and should be returned to a service center or recycling service center. If the new battery pack displays the same problem as the original Battery Pack, have the charger tested at an authorized service center.

Light	ON/ Flash	Status
Red on 	————	Defective Battery
Red flash 	-----	Battery Temperature Protection The temperature of battery pack is less than 0°C or more than 45°C.

Green on 	————	Fully Charged
Green flash 	-----	Charging

BATTERY TEMPERATURE PROTECTION

This charger has a battery temperature protection feature. When the charger detects a battery pack that is too hot or cold (the light will be red and flash), it automatically activates the protection circuit, and suspends charging until the battery pack has reached the correct temperature. The charging process will then automatically begin (the light will be green and flash). This feature ensures maximum battery life.

LEAVING THE BATTERY PACK IN THE CHARGER

If a fully charged battery pack is left in the charger, the Light will remain green. The battery pack will remain charging with a maintenance trickle current.

DEFECTIVE BATTERY PACKS

This charger will detect a defective battery pack. When a defective battery pack is inserted into the charger, the charger will try to repair it. This process will last about 30mins (the light will be green and flash). If the repair is successful, the charger will automatically begin to charge the battery pack to the highest capacity possible (the light will be green and flash). If the light becomes solid red, the battery pack is dead.

NOTE: Repaired battery packs are still usable but should not be expected to perform as much work as new battery packs.

IMPORTANT CHARGING NOTES:

1. For a new battery or a battery that has been in storage for sometime, please recharge the battery before use. If you want to store the battery for a long time, please fully charge the battery pack to ensure maximum battery life.
2. Longer life and better performance can be obtained if the battery pack is charged when the air temperature is between (18°C-24°C). Do not charge the battery pack in air temperatures below 0°C, or above 40°C. This is important as it can prevent serious damage to the battery pack.
3. Never freeze your charger or immerse charger in water or any other liquid.
4. When the battery pack fails to produce sufficient power on jobs that were previously done easily, please recharge your battery, do not continue to use under this condition. You may charge a partially used pack whenever you desire with no adverse affect on the battery pack.
5. When charging it is normal that the charger and

- battery pack may become warm to touch.
6. If the battery pack does not charge properly:
 - a. Check current at power outlet by plugging in another appliance.
 - b. Plug and unplug to check whether the charger is ok
 - c. Check whether the battery has been damaged
 - d. Move the charger and battery pack to a location where the surrounding air temperature is approximately 18°-24°C.
 - e. If the charging problem persists, take the tool, battery pack and charger to an authorized service center.
 - f. Under certain conditions, when the charger is plugged into the power supply, the exposed charging contacts inside the charger can be shorted by foreign material. Foreign materials of a conductive nature such as metallic particles should be kept away from charger cavities. Always unplug the charger from the power supply when there is no battery pack in the charger or before attempting to clean.

PROBLEM SOLUTION

I CANNOT FIT THE BATTERY INTO THE BATTERY CHARGER. WHY?

- a) Check if the charger and the battery pack are specifically designed for working together.
- b) The battery can be inserted into the charger only in one direction. Turn the battery around until it can be inserted into the slot, the indicator light should be green and flash when the battery is charging.

REASONS FOR DIFFERENT CHARGING TIMES

The charging time can be affected by many reasons which are not defects in your product.

- a) If the battery pack is only partly discharged it may be re-charged in less than rated charging time.
- b) If the battery pack and ambient temperature are very cold/ hot, it may take longer to re-charge. Please find an appropriate environment with proper air temperature to start charging.
- c) If the battery pack is very hot, remove battery pack from the charger and allow battery pack to cool first to ambient temperature and then recharging can be started.

MAINTENANCE

Remove the plug from the socket before carrying out any adjustment, servicing or maintenance.

Your battery charger requires no additional lubrication or maintenance. Never use water or chemical cleaners to clean your charger. Wipe clean with a dry cloth. Always store your charger in a dry place. If the supply cord is damaged, it must be replaced by the manufacturer, its service agent or similarly qualified persons in order to avoid a hazard.

Positec Australia Pty Limited
10 Corporate Blvd Bayswater , VIC 3153, Australia

ENVIRONMENTAL PROTECTION



Waste electrical products must not be disposed of with household waste. Please recycle where facilities exist. Check with your local authorities or retailer for recycling advice.

PLUG REPLACEMENT (ONLY FOR REWIRABLE PLUG OF UK & IRELAND)

If you need to replace the fitted plug then follow the instructions below.

IMPORTANT

The wires in the mains lead are colored in accordance with the following code:

Blue = Neutral

Brown = Live

As the colors of the wires in the mains lead of this appliance may not correspond with the colored markings identifying the terminals in your plug, proceed as follows. The wire which is colored blue must be connected to the terminal which is marked with N. The wire which is colored brown must be connected to the terminal which is marked with L.

WARNING!

Never connect live or neutral wires to the earth terminal of the plug. Only fit an approved BS1363/A plug and the correct rated current fuse which is used in the plug.

NOTE: If a moulded plug is fitted and has to be removed take great care in disposing of the plug and severed cable, it must be destroyed to prevent engaging into a socket.

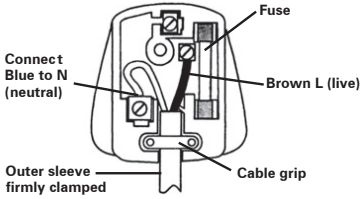

DECLARATION OF CONFORMITY

We,
Positec Germany GmbH
Postfach 32 02 16, 50796 Cologne, Germany

On behalf of Positec declare that the product,
Description **Worx Battery Charger**
Type **WA3880**

Complies with the following Directives,
2014/35/EU
2014/30/EU
2011/65/EU&(EU)2015/863

Standards conform to
EN 60335-1
EN 60335-2-29
EN 62233,
EN 55014-1
EN 55014-2
EN IEC 61000-3-2
EN 61000-3-3



11

2022/01/28
Allen Ding
Deputy Chief Engineer, Testing & Certification
Positec Technology (China) Co., Ltd
18, Dongwang Road, Suzhou Industrial
Park, Jiangsu 215123, P. R. China

DECLARATION OF CONFORMITY

We,
Positec (UK & Ireland) Ltd
PO Box 6242, Newbury, RG14 9LT, UK

On behalf of Positec declare that the product,

Description **Worx Battery Charger**

Type **WA3880**

Complies with the following regulations,
Electrical Equipment (Safety) Regulations 2016
Electromagnetic Compatibility Regulations 2016
The Restriction of the Use of Certain Hazardous Substances in Electrical and Electronic Equipment Regulations

Standards conform to

BS EN 60335-1, BS EN 60335-2-29, BS EN 62233, BS EN 55014-1, BS EN 55014-2, BS EN IEC 61000-3-2, BS EN 61000-3-3,



12

2022/01/28
Allen Ding
Deputy Chief Engineer, Testing & Certification
Positec Technology (China) Co., Ltd
18, Dongwang Road, Suzhou Industrial
Park, Jiangsu 215123, P. R. China



After-sales Service and Application

At www.worx.com you can order spare parts or arrange the collection of a product in need of servicing or repair.

Tel. Service: 0345 202 9679

E-Mail: customerservices@worxtools.com

www.worx.com

Copyright © 2022, Positec. All Rights Reserved.

AR03030406

Battery Charger

WA3880