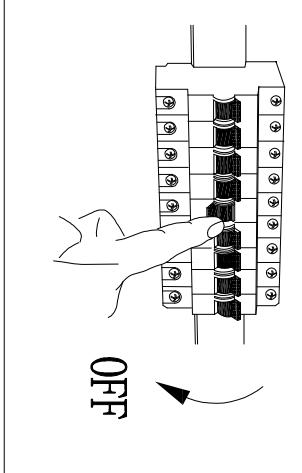
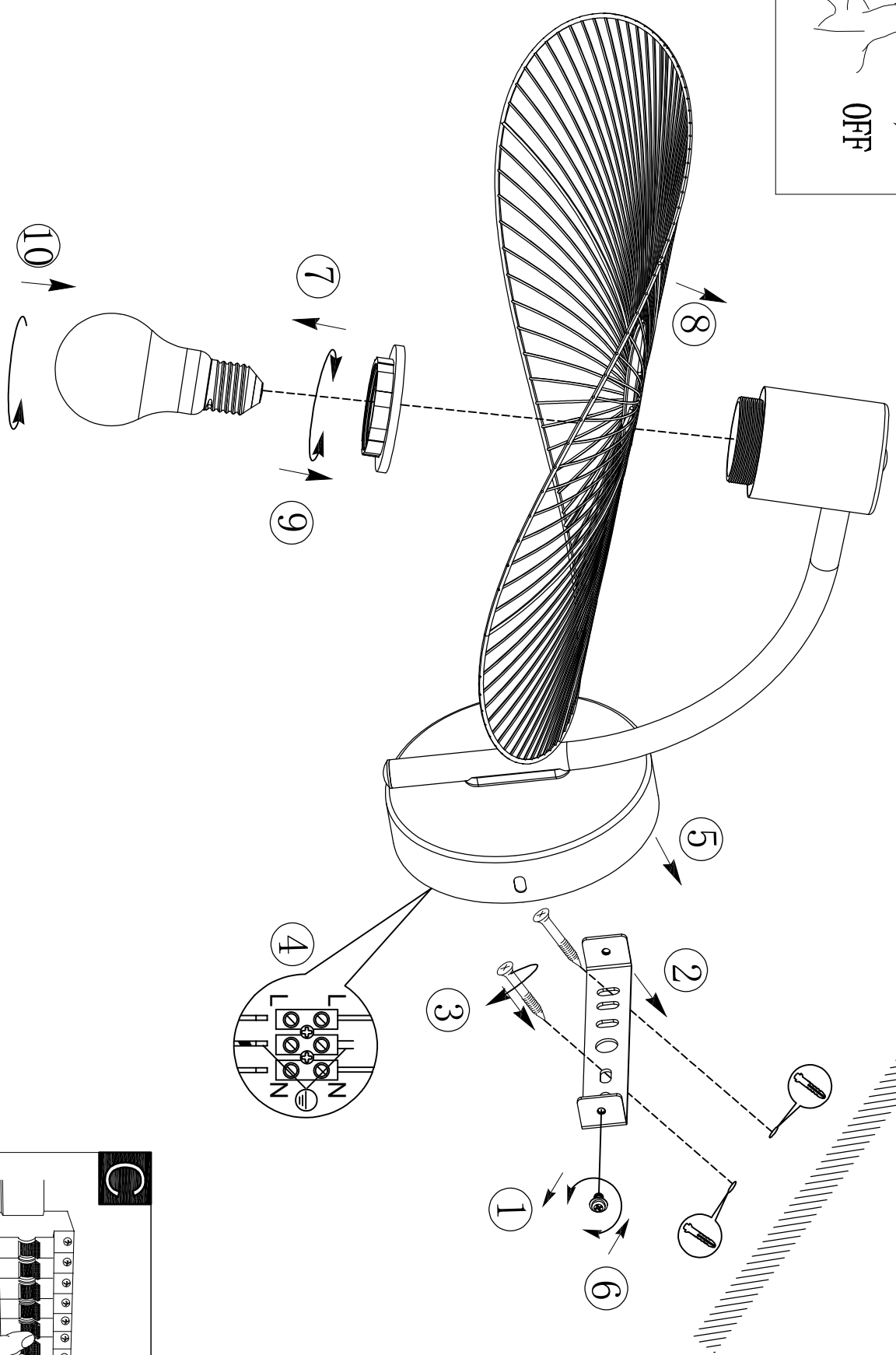
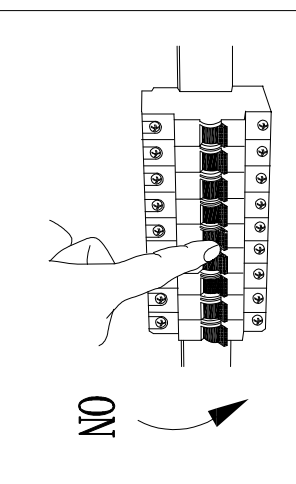

A**B****C**

B31964

www.eglo.com