

VisioDoor wi-Fi

Interphone vidéo connecté filaire

Smart wired video doorphone
Videocitofono intelligente cablato
Videoportero intelligente con cable

PVF0056

VisioDoor wi-Fi



2 fils
100m max



Ecran tactile



Contrôle
à distance



REC
Photos/
vidéos



6 mélodies



Gâche
et portail



Notice d'utilisation et d'installation



Installation and user manual



Manuale d'installazione e uso



Instrucciones de uso e instalación

SOMMAIRE

A- Précautions d'utilisation	2
B- Descriptif	2
C- Câblage / Installation	3
D- Utilisation	5
E- Réglages.....	7
F- Configuration de l'application.....	9
G- Paramétrage.....	12
H- Caractéristiques techniques.....	16
I- Assistance technique	17
J- Garantie	17
K- Avertissements	17
L- Déclaration de conformité	18

A- PRÉCAUTIONS D'UTILISATION

Ce manuel fait partie intégrante de votre produit. Ces instructions sont pour votre sécurité. Lisez-les attentivement avant utilisation et conservez-les pour une consultation ultérieure. Choisir un emplacement approprié. S'assurer qu'aucun élément ne gêne à l'insertion des chevilles et des vis dans le mur. Ne pas brancher votre alimentation tant que votre installation n'est pas terminée et contrôlée. La mise en œuvre, les connexions électriques et les réglages doivent être effectués dans les règles de l'art par une personne qualifiée et spécialisée. Le bloc d'alimentation doit être installé dans un lieu sec. Vérifier que ce produit est utilisé uniquement pour l'usage auquel il est destiné.

La fonction de ce visiophone est d'identifier un visiteur, il ne doit pas être utilisé pour la surveillance de la rue. L'utilisation de cette installation doit se faire dans le respect de la Loi n° 78-17 du 6 janvier 1978 relative à l'informatique, aux fichiers et aux libertés. Il appartient à l'acheteur de se renseigner auprès de la CNIL en cas de questionnement sur les conditions et les autorisations administratives nécessaires en cas d'usage en dehors d'un cadre strictement personnel. SCS Sentinel ne pourra être tenu responsable en cas d'utilisation de ce produit en dehors des lois et réglementations en vigueur.

Ce produit fonctionne avec l'application iSCS Sentinel uniquement. L'application est disponible gratuitement sur le PlayStore et l'AppStore. Les mises à jour de l'application peuvent être nécessaires, par exemple pour corriger des bugs, améliorer des fonctionnalités, et bénéficier d'une meilleure expérience utilisateur. Vous pouvez activer ou désactiver le caractère automatique des mises à jour de l'application iSCS Sentinel dans les paramètres du PlayStore ou de l'AppStore. Les informations concernant la raison de la mise à jour, son impact sur les performances et l'évolution des fonctionnalités du produit ou de l'application ainsi que l'espace de stockage utilisé, sont indiquées, pour chaque mise à jour, sur le PlayStore ou l'AppStore.

Conformément à la réglementation et la garantie légale, la disponibilité de l'application et de ses mises à jour est garantie pour une durée de 2 ans.

Cette notice peut être amenée à évoluer selon les mises à jour de l'application. Afin d'être sûr d'avoir la dernière version, nous vous conseillons de la télécharger sur notre site internet www.scs-sentinel.com

B- DESCRIPTIF

B1- Contenu du kit / Dimensions

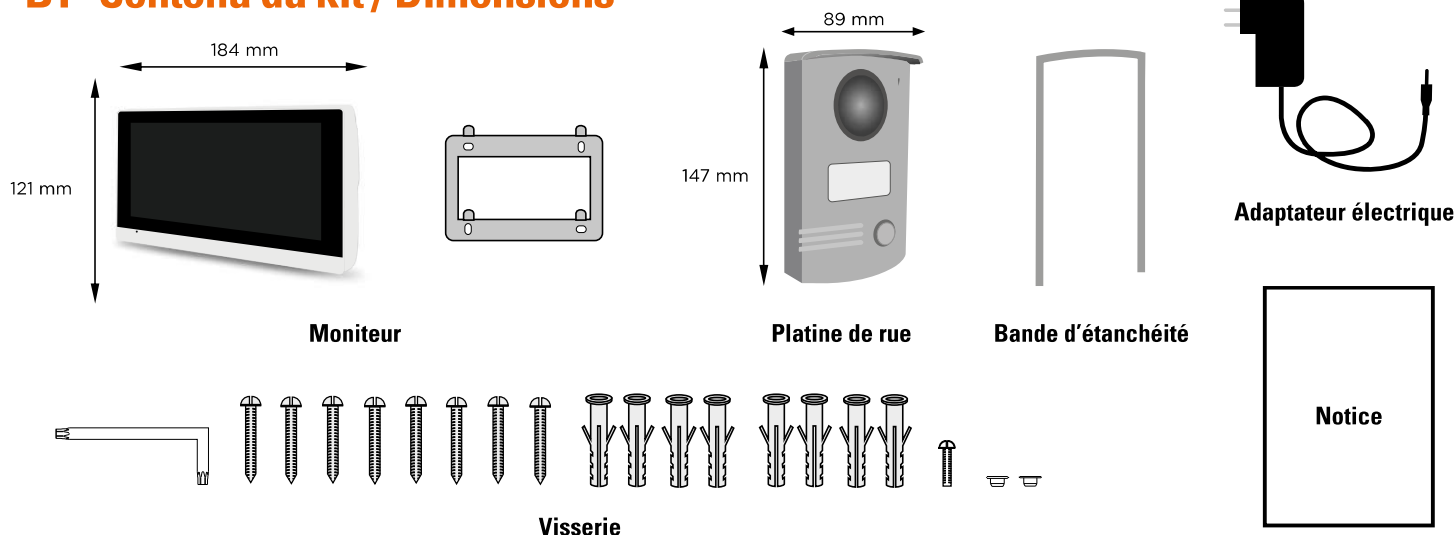

B2- Présentation du produit

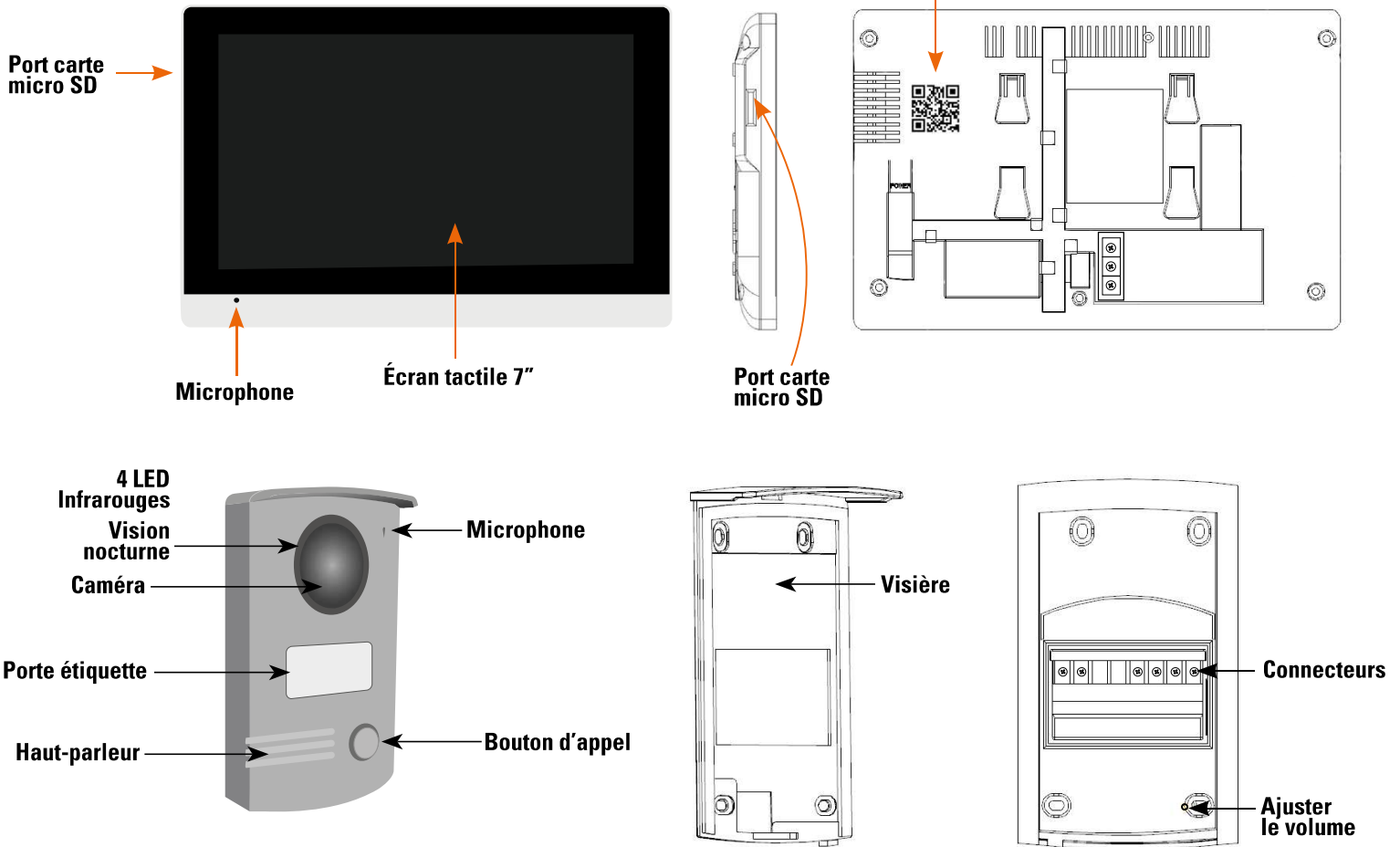

C- CÂBLAGE / INSTALLATION

C1- Installation et raccordement

Moniteur

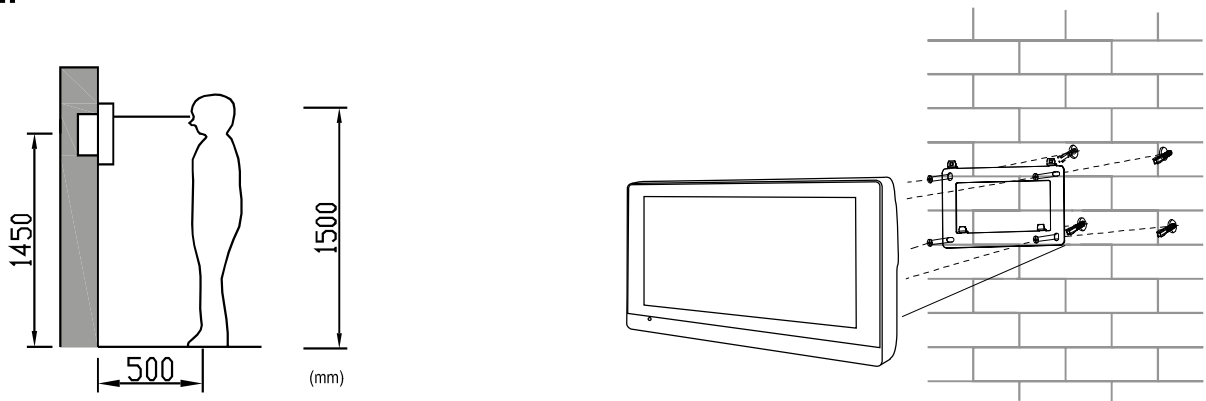

Platine de rue

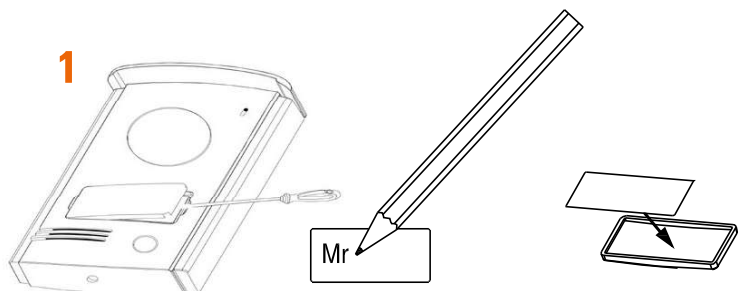
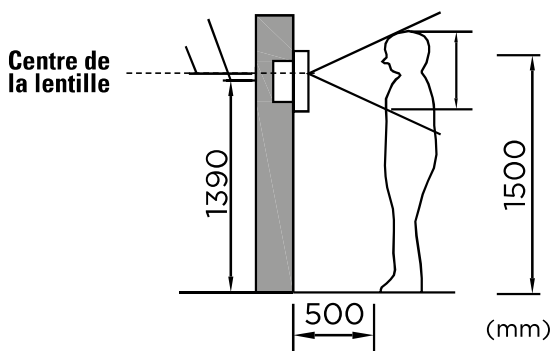

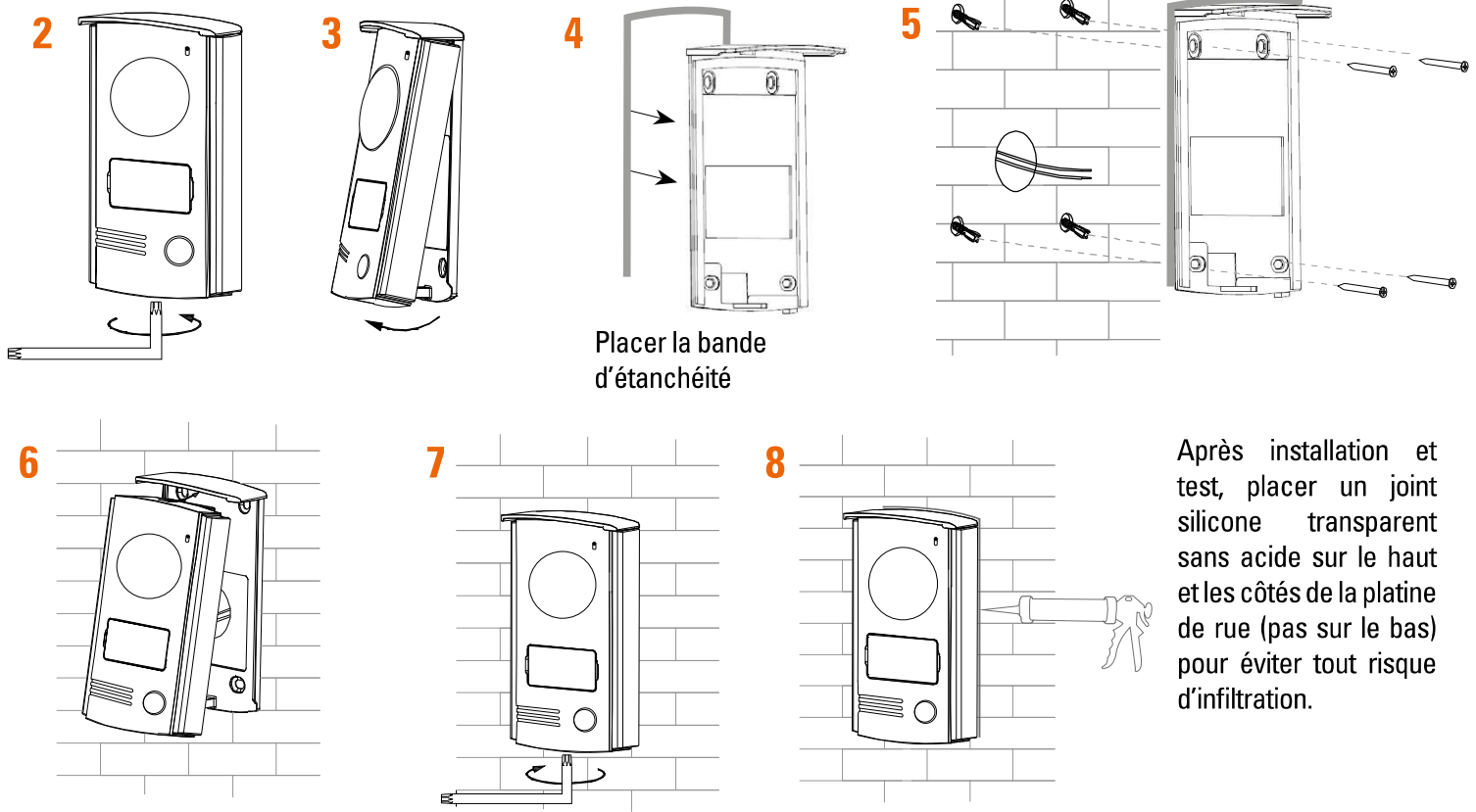

Placer la bande d'étanchéité

Après installation et test, placer un joint silicone transparent sans acide sur le haut et les côtés de la platine de rue (pas sur le bas) pour éviter tout risque d'infiltration.

C2- Schéma de câblage

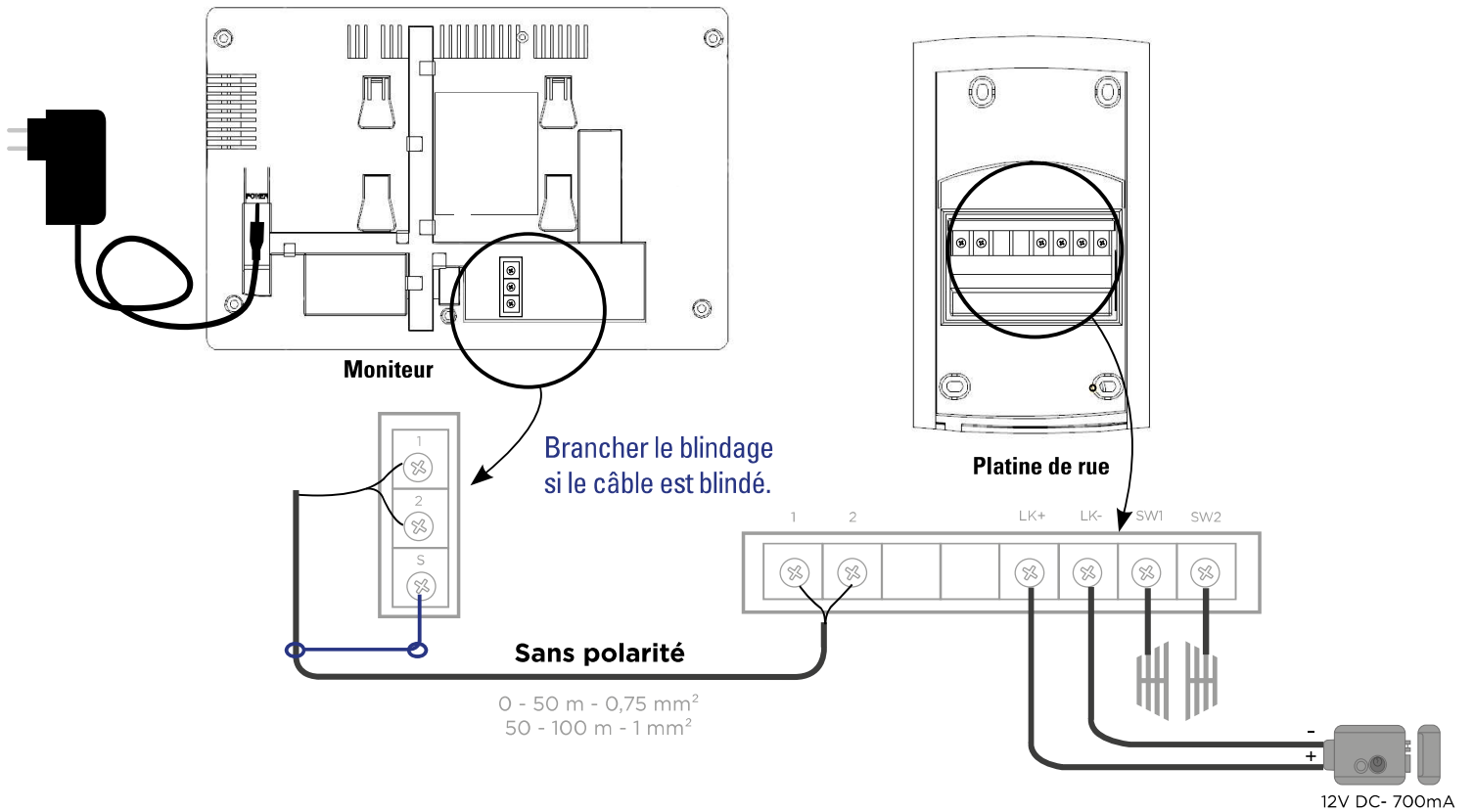

Vous avez la possibilité de connecter le moniteur directement à votre tableau électrique via un transformateur « rail DIN » de 15V DC 0,8A minimum. Des connaissances électriques étant nécessaires, nous vous conseillons de faire dans ce cas appel à un professionnel.

ATTENTION : RESPECTEZ LA POLARITÉ !
Le fil avec les traits gris doit être positionné sur le +. Le fil avec les écritures doit être positionné sur le -.

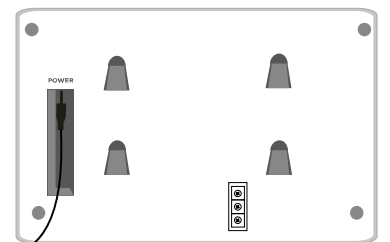
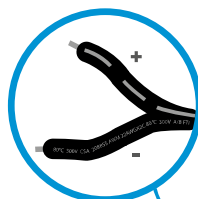

D- UTILISATION

D1- Appel depuis la platine de rue



Durée de la sonnerie en cours
(en secondes)

- Réglages écran
- Ouverture portail
- Ouverture gâche / serrure
- Enregistrer une vidéo
- Enregistrer une photo
- Décrocher / Raccrocher
- Retour à l'écran d'accueil
(l'appel en absence ne sera pas signalé)

D2- Écran principal

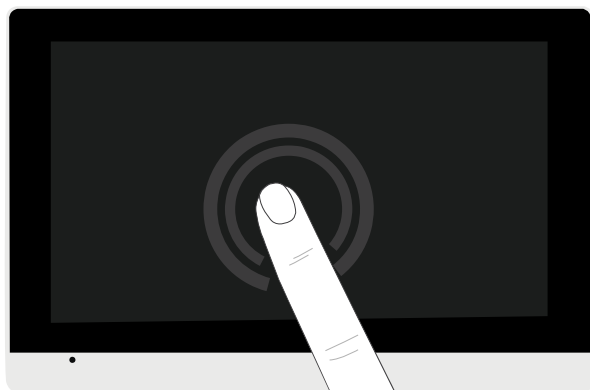

Pour quitter le mode veille, toucher l'écran

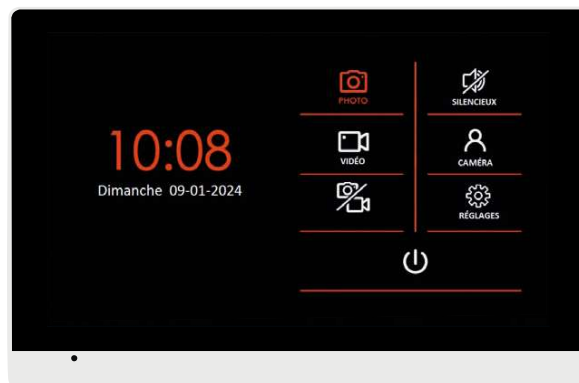

Visionner les photos



Visionner les vidéo



Activer/désactiver
la capture photo / vidéo automatique



Mise en veille de l'écran
(l'écran s'éteint automatiquement après 1 minute)



Mode silencieux (cette icône s'affichera
en haut de votre écran si le mode
silencieux est choisi)



Visualiser la caméra



Réglages

D3- Affichage des photos et vidéos

Photos

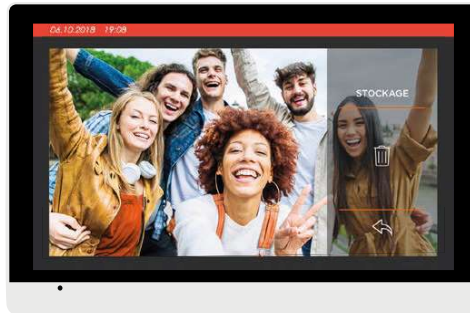

 Afficher les photos du moniteur

 Supprimer une photo

 Retour à l'écran d'accueil

D4- Mode silencieux

Mode silence

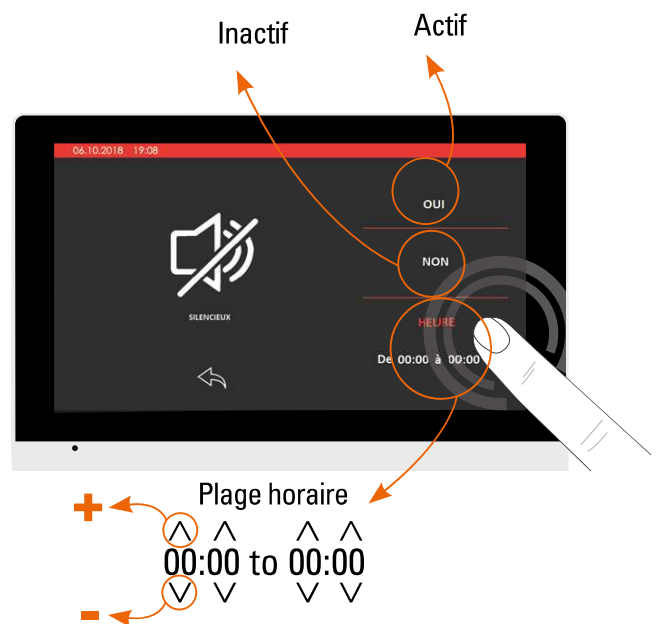
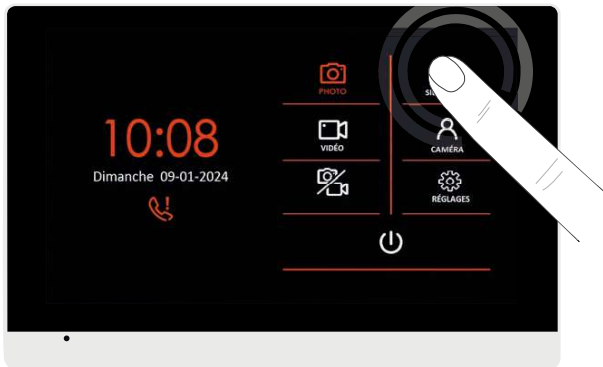

D5- Affichage caméra

Caméra

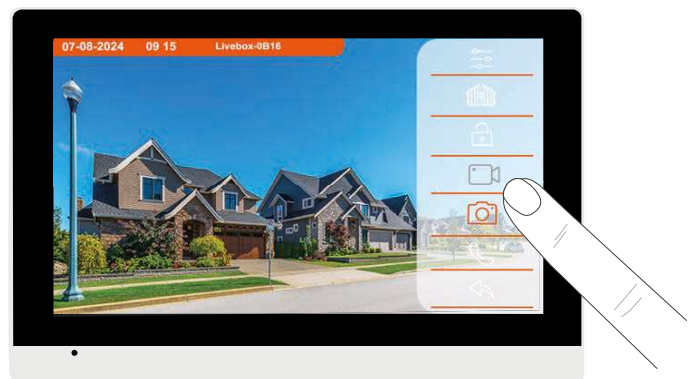
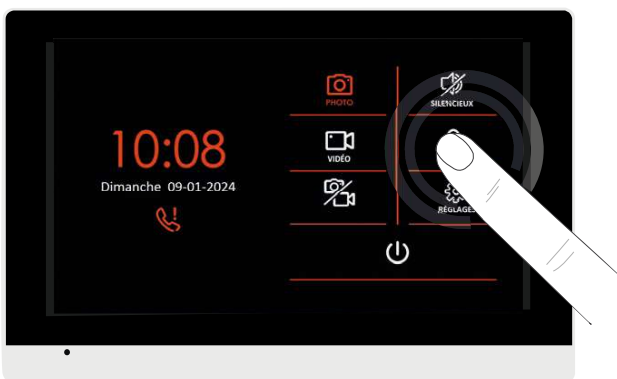

Vous avez accès de chez vous à la vue de la platine de rue en cliquant sur l'icône caméra

E- RÉGLAGES

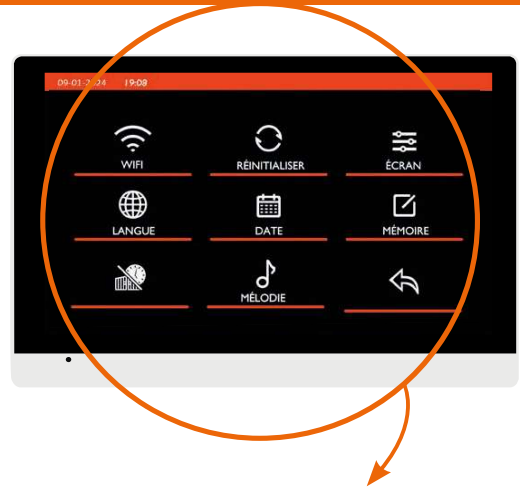
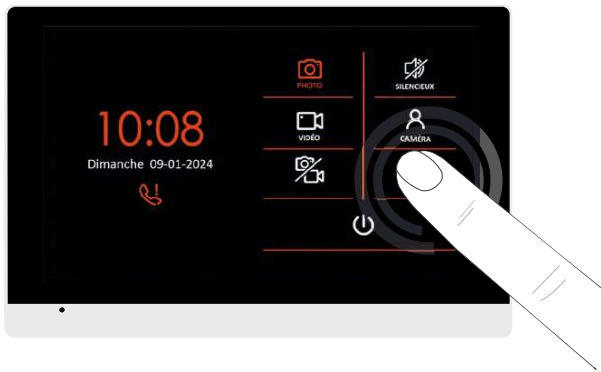

 Wi-Fi	 Réinitialiser	 Réglages écran
 Choix langue (moniteur)	 Réglage date et heure	 Supprimer toutes les photos et les vidéos
 Durée de fermeture du contact sec pour le portail	 Choix mélodie	 Retour à l'écran d'accueil

Wi-Fi



Mode hors-ligne

Accéder à la liste des réseaux Wi-Fi

Activation du Wi-Fi

Pour réinitialiser le Wi-Fi



Mélodie



Rappel de sonnerie activé



Rappel de sonnerie désactivé



Choisir la durée de la sonnerie
30, 60 ou 90 secondes

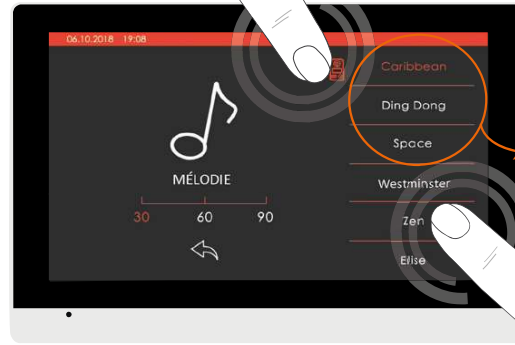

Sélectionner
une mélodie

3 mélodies premium
avec rappel de
sonnerie possible sur
la platine de rue



Réinitialiser

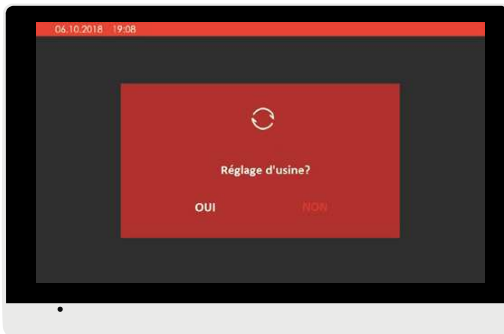

Cette fonction permet de rétablir toutes les données
et tous les réglages initiaux de l'appareil.

-  Luminosité
-  Couleur
-  Contraste
-  Volume sonnerie
-  Volume voix
-  Retour
à l'écran d'accueil



Réglages écran



Choix langue

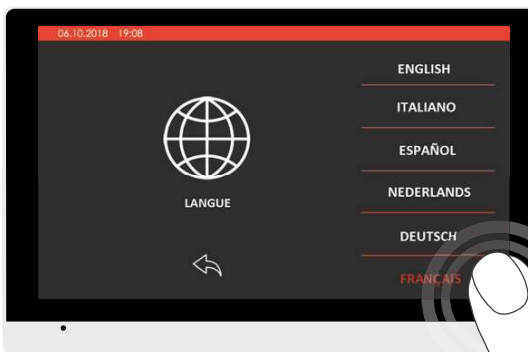



Réglage date et heure



Sauvegarde sur carte micro SD

Réglage date et heure automatique (si connexion Internet)

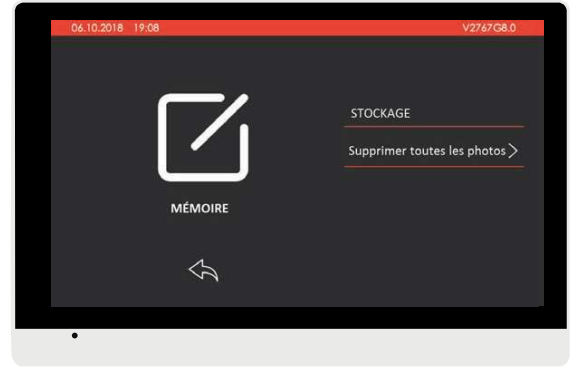
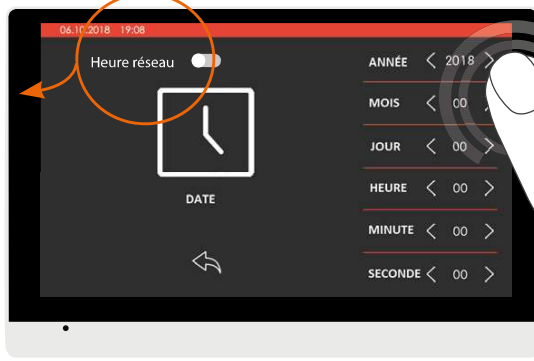

F- CONFIGURATION DE L'APPLICATION

Installation de l'application



iSCS Sentinel

Pour télécharger l'application, connectez-vous sur l'App Store ou le Play Store de votre smartphone. Recherche «iSCS Sentinel», cliquez ensuite sur Installer.

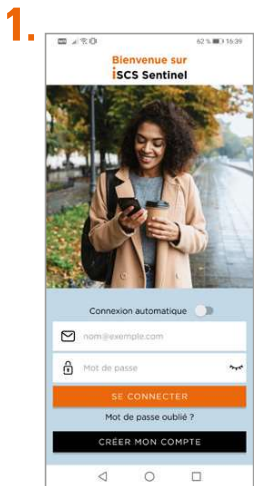

1. Lorsque le téléchargement est terminé, ouvrir l'application et cliquer sur «CRÉER MON COMPTE.»



2. Renseigner l'adresse mail ainsi que le mot de passe dans les cases correspondantes.

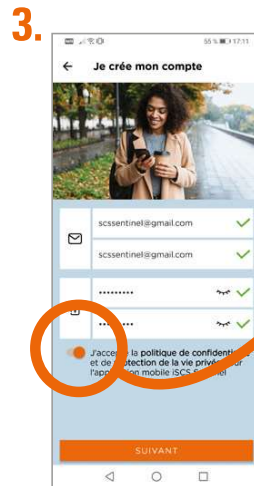

3. Appuyer sur «SUIVANT».



Il est nécessaire d'accepter la politique de confidentialité avant de cliquer sur suivant.

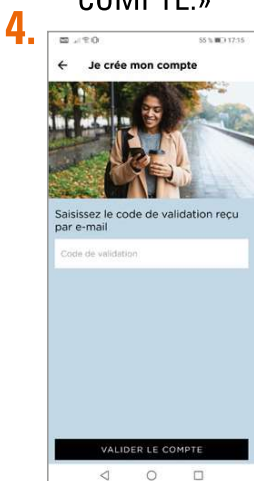

4. Renseigner le code de validation reçu par mail. Puis valider le compte.

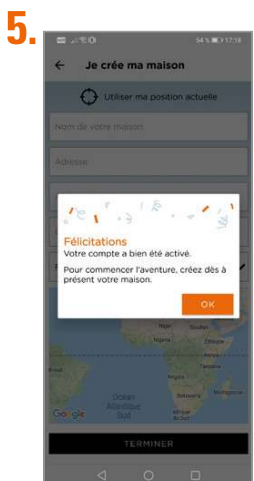

5.



6. Appuyer sur «AUTORISER».

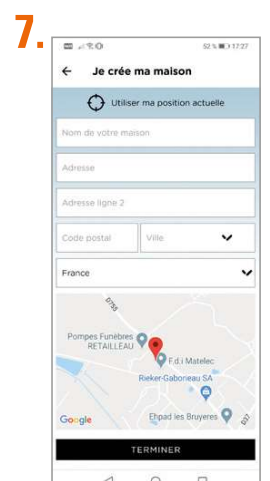

7. Renseigner toutes les informations demandées pour créer une maison. Cliquer sur «TERMINER».

Ajout du moniteur

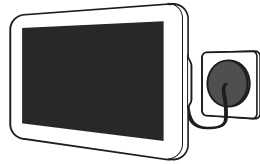
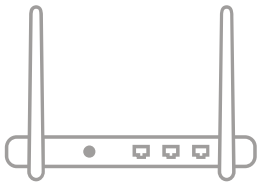

Brancher l'alimentation du moniteur et le placer à proximité du routeur Wi-Fi. Le téléphone doit être connecté au même réseau Wi-Fi que le moniteur et la localisation doit être activée.



Certains matériaux peuvent réduire la portée du signal Wi-Fi.

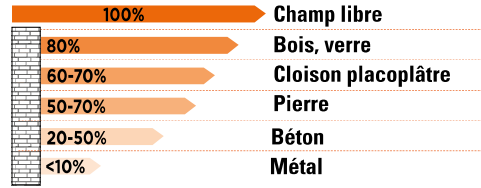

Appuyer sur + puis sur «NOUVEL APPAREIL» pour ajouter le visiophone.



Le réseau doit être en 2.4 GHz pour fonctionner.



Renseigner la clé Wi-Fi, flasher le QR Code au dos du moniteur ou entrer le code manuellement.



Sur le moniteur, aller dans réglages puis appuyer sur l'icône «Wi-Fi». Attendre que le bouton OK apparaisse en surbrillance. Sélectionner le réseau Wi-Fi et taper le mot de passe.

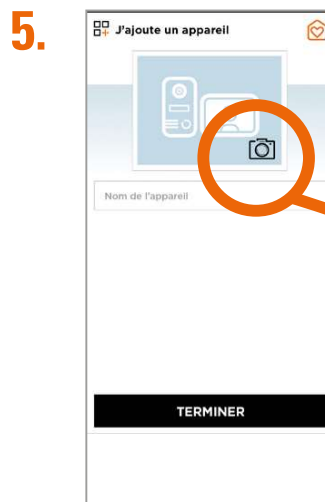

Nommer le visiophone et la pièce dans laquelle le produit se trouve.

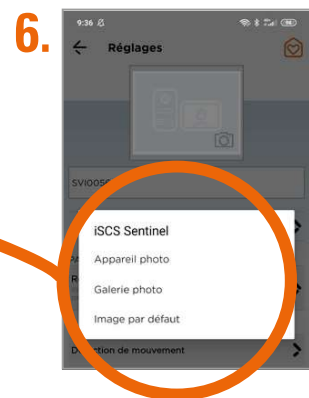

Ajouter une photo de profil à partir de l'appareil photo, de la galerie ou sélectionner une image par défaut (visuel du produit ou dernière capture de mouvement.)



En cas d'échec lors de la connexion de l'appareil au Wi-Fi, une page d'erreur apparaît.

Résolution en cas d'échec

1.



2.



«répéter l'opération» fait revenir à la 2^{ème} étape.



Si «répéter l'opération» ne fonctionne pas, appuyer sur «autre méthode»

3.

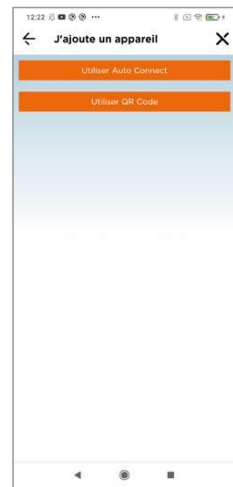

Cliquer sur «QR Code»

Vérifier ces 5 points.

4.



Vérifier les informations et cliquer sur suivant.

5.

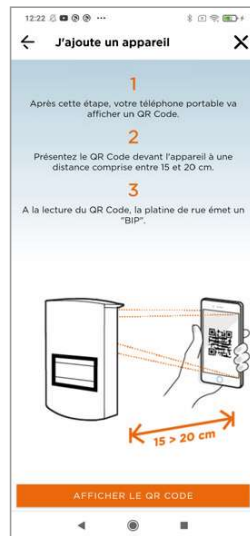

Cliquer sur «afficher le QR Code»

6.



Scanner le QR Code affiché avec la platine puis, après le signal sonore, appuyer sur «oui».



Le chargement s'effectue et les 3 étapes sont validées. Vous revenez ainsi à l'étape 5 et 6 pour changer la photo de profil.

G- PARAMÉTRAGE

Réglages de l'application



Pour ajouter une maison



Cliquer sur 

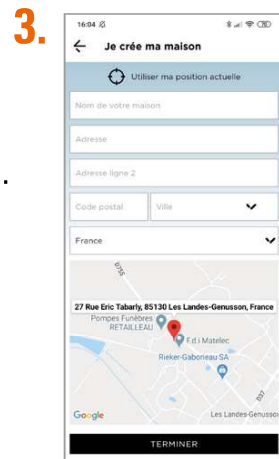
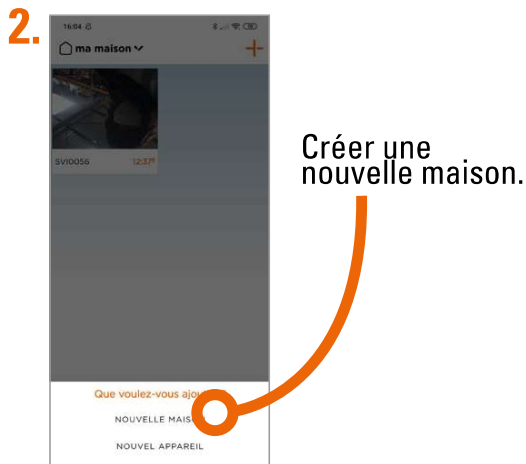

Renseigner les champs et appuyer sur «TERMINER».

Pour supprimer une maison



Appuyer sur 

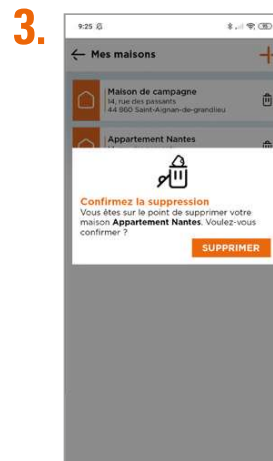
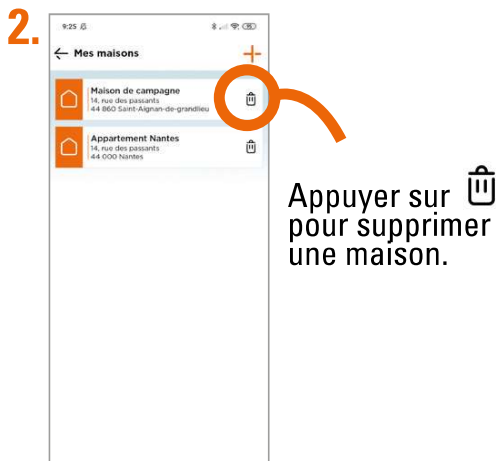

Pour modifier une maison



- 

Appuyer sur 
- 

Modifier l'adresse.
- 

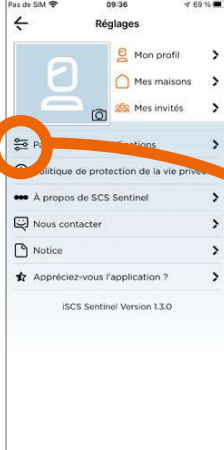
Paramètres de notifications

- 

Appuyer sur  pour accéder aux paramètres de notifications.
- 

Appuyer sur «Activer les notifications» pour activer la totalité des notifications. Sinon appuyer sur les notifications souhaitées.

Utilisation de l'application

- 

Appuyer pour parler.

Activer l'écoute.
- 

Capturer la photo dans votre téléphone.

Capturer la vidéo dans votre téléphone.

Activer le plein écran (basculer le téléphone).
- 

Ouvrir ou fermer le portail

Déclencher la gâche

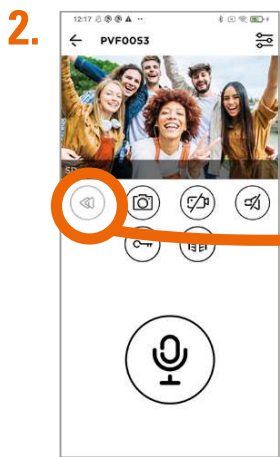

2. Visionner ce qu'il s'est passé.



Enregistrer une vidéo

Enregistrer une photo

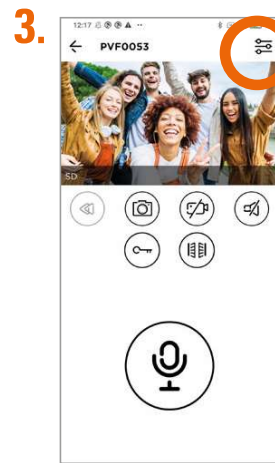

3. Appuyer sur  pour modifier les paramètres du visiophone.



Par défaut, le visiophone apparaîtra dès l'ouverture de l'application dans la liste des favoris.

Appuyer sur  pour ajouter/supprimer le visiophone des favoris.

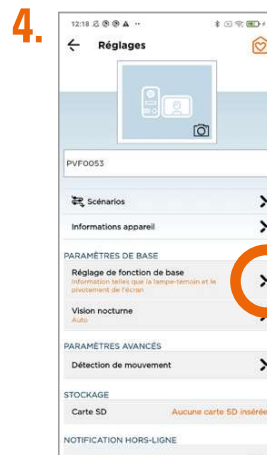

4. Appuyer sur réglages de fonction de base.

Réglages carte SD (si une carte est insérée dans le moniteur)



1. Appuyer sur «carte micro SD» pour accéder aux réglages.

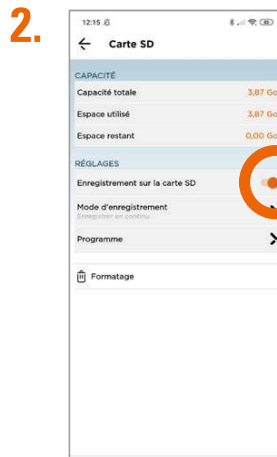

2. Appuyer sur «Enregistrement sur la carte micro SD» pour que les photos et vidéos soient automatiquement enregistrées sur la carte micro SD du moniteur.

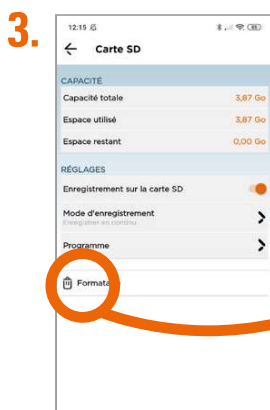

3. Appuyer sur «formatage» pour remettre à zéro la carte micro SD.

Scénarios

Un scénario est une action qui suit un/des événement(s) déclencheurs.

- 1 Sélectionnez le/les événements déclencheurs. Si vous avez plusieurs déclencheurs, vous avez le choix entre les combiner ensemble (ET) ou les dissocier pour réaliser l'action (OU).
- 2 Définissez le/les actions à réaliser.
- 3 Enregistrez votre scénario.

Ensuite, l'application lancera le/les action(s) du scénario, lorsqu'il aura repéré un déclencheur

SUIVANT

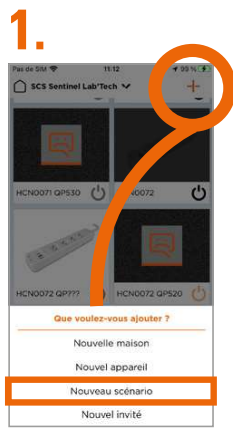

Pour sélectionner un ou des événements déclencheurs (appareil, date/heure ou lieu) appuyer sur +



Pour sélectionner une ou des actions (appareil, notification ou délai) appuyer sur +



Par défaut, le scénario apparaîtra dans la liste des favoris.



Le scénario est activé

Activer les «actions» du scénario sans attendre les «événements déclencheurs»

Ajouter des invités

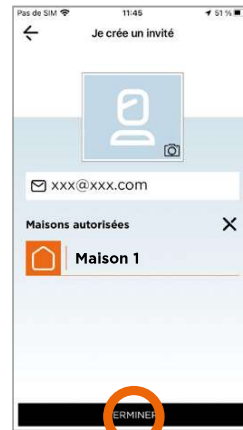

⚠ Via l'application **iSCS Sentinel**, un invité peut activer / désactiver les appareils mais il ne peut pas les paramétrer.

Reset

Pour totalement supprimer l'appareil il faudra le supprimer dans l'application.



H - CARACTÉRISTIQUES TECHNIQUES

Moniteur

Alimentation	15V DC 0.8A 12W
Ecran	Ecran tactile 7" TFT LCD
Résolution LCD	1024 x 600 px
Mémoire interne (photos)	14 Mo. Une fois la mémoire pleine, la nouvelle photo remplacera automatiquement la plus ancienne
Mémoire externe possible sur carte micro SD (photos ou vidéos)	4 Go - 32 Go classe 4 - 10 (non fournie) la carte micro SD doit être formatée avant utilisation
Fréquence de fonctionnement	2412 MHz - 2472 MHz
Puissance maximale d'émission	< 100mW
Wi-Fi	802 11b/g/n

Platine de rue

Matériau	Alliage d'aluminium
Angle de vue	100°
Vision nocturne	LED infrarouges
Température de fonctionnement	-10°C /+ 50°C
Indice de protection	IP55

Adaptateur électrique

Référence du modèle	SH-7000-15-1A
Tension d'entrée	110-240V AC
Fréquence du CA d'entrée	50/60Hz
Tension de sortie	15V DC
Courant de sortie	0.8A
Puissance de sortie	12W
Rendement moyen en mode actif	84.03%
Rendement à faible charge (10%)	78.41%
Consommation électrique hors charge	0.084W

I - ASSISTANCE TECHNIQUE

Conseils d'expert

En cas de besoin, vous pouvez prendre contact avec nos experts au numéro ci-dessous. Notre équipe de techniciens et de techniciennes, basée en France, assure un conseil avisé et personnalisé.



0 892 350 490

Service 0,15 € / min
+ prix appel

Horaire du service, voir sur le site internet : scs-sentinel.com/contact

Nous vous demandons au préalable de relever la référence de votre matériel sur la notice ou l'emballage de votre produit. Nous vous conseillons également de brancher votre matériel « en fils volants » sur une table après avoir démonté les éléments.

Chat' en ligne



Une question ?

Pour une réponse personnalisée, utilisez notre chat' en ligne sur notre site web www.scs-sentinel.com

Prenez rendez-vous avec nos experts



Notre service de prise de rendez-vous par visioconférence est là pour vous aider.

Ces sessions sont spécialement conçues pour répondre à vos besoins en installation ou dépannage de manière efficace et ciblée. Grâce à la visioconférence, vous pouvez montrer à notre équipe d'experts votre installation actuelle, poser des questions en temps réel et bénéficier de conseils précis étape par étape pour résoudre vos problèmes rapidement.

Pour plus d'informations sur ce service payant, rendez-vous sur notre site internet scs-sentinel.com (services)

J- GARANTIE



SCS Sentinel accorde à ce produit une garantie supérieure à la durée légale, en gage de qualité et de fiabilité.

Il est impératif de garder une preuve d'achat durant toute la période de garantie.

Conservez soigneusement le code-barre ainsi que votre justificatif d'achat, il vous sera demandé pour faire jouer la garantie.

K- AVERTISSEMENTS

- Garder une distance minimale (10 cm) autour de l'appareil pour une aération suffisante.
- Ne pas gêner l'aération par l'obstruction des ouvertures d'aération par des objets tels que journaux, nappes, rideaux, etc.
- Ne pas approcher l'appareil de flammes nues, telles que des bougies allumées.
- Le fonctionnement normal du produit peut être perturbé par une forte interférence électromagnétique.
- Cet équipement est destiné à un usage privé uniquement.
- L'appareil ne doit pas être exposé à des égouttements d'eau ou des éclaboussures. Aucun objet rempli de liquide tel que des vases ne doit être placé sur l'appareil.
- La prise du réseau d'alimentation doit demeurer aisément accessible. Elle est utilisée comme dispositif de déconnexion.
- Le moniteur et l'adaptateur doivent être utilisés en intérieur.
- Effectuer tous les branchements entre les éléments avant d'alimenter le kit.
- Ne brancher votre appareil qu'avec l'adaptateur fourni.
- Les éléments étant composés d'électronique, ils sont à manipuler avec précaution.
- Ne pas boucher le microphone de la platine de rue et du moniteur.
- Lors de l'installation de votre produit, ne pas laisser les emballages à la portée des enfants ou des animaux. Ils représentent une source potentielle de danger.
- Ce produit n'est pas un jouet. Il n'a pas été conçu pour être utilisé par des enfants.

 Avant tout entretien, débrancher vos appareils. Ne pas nettoyer le produit avec des solvants, des substances abrasives ou corrosives. Utiliser un simple chiffon doux pour nettoyer l'écran du moniteur. Ne rien vaporiser sur le produit.

 Assurez-vous de la bonne maintenance de votre produit et vérifiez fréquemment l'installation pour déceler tout signe d'usure. N'utilisez pas l'appareil si une réparation ou un réglage est nécessaire. Faites appel à du personnel qualifié.

 Ne jetez pas les appareils hors d'usage avec les ordures ménagères. Les substances dangereuses qu'ils sont susceptibles de contenir peuvent nuire à la santé et à l'environnement. Utilisez les moyens de collectes sélectives mis à votre disposition par votre commune ou votre distributeur.



— Courant continu

~ Courant alternatif

 Modèle de classe II

 Le moniteur est destiné à une utilisation intérieure uniquement

IP 55 : L'unité extérieure est protégée contre les dépôts nuisibles de poussières et contre les jets d'eau de toutes les directions à la lance.



L- DÉCLARATION DE CONFORMITÉ

Par la présente, SCS Sentinel déclare que ce produit est conforme aux exigences essentielles et autres dispositions pertinentes de la directive 2014/53/UE. La déclaration de conformité peut être consultée sur le site : www.scs-sentinel.com/downloads

TABLE OF CONTENTS

A- Safety instructions	19
B- Description	19
C- Wiring / Installation	20
D- Use	22
E- Settings.....	24
F- Technical features.....	26
G-Setting	29
H-Technical features	33
I- Technical assistance.....	34
J-Warranty.....	34
K- Warnings.....	34
L- Declaration of conformity	34

A- SAFETY INSTRUCTIONS

This manual is an integral part of your product.

These instructions are provided for your safety. Read this manual carefully before installing and keep it in a safe place for future reference. Select a suitable location. Make sure you can easily insert screws and wallplugs into the wall. Do not connect your electrical appliance until your equipment is totally installed and controlled. The installation, electric connections and settings must be made using best practices by a specialized and qualified person. The power supply must be installed in a dry place. Check the product is only used for its intended purpose. The function of this videophone is to identify a visitor, it must not be used for street surveillance. The use of this installation must be in compliance with the French law n° 78-17 of January 6, 1978 relating to data processing, files and freedoms. It is up to the buyer to ask the CNIL about the conditions and administrative authorisations required for use outside a strictly personal context. SCS Sentinel cannot be held responsible in case of use of this product outside the laws and regulations in force.

This product works with the iSCS Sentinel app only. The application is available for free on the PlayStore and the AppStore. Application updates may be necessary, for example to fix bugs, improve features, and benefit from a better user experience. You can enable or disable automatic updates for the iSCS Sentinel application in the PlayStore or AppStore settings. The information concerning the reason for the update, its impact on the performance and the evolution of the functionalities of the product or application as well as the storage space used, are indicated, for each update, on the PlayStore or the Apple Store.

In accordance with the regulations and the legal guarantee, the application availability and updates are guaranteed for a period of 2 years. **This manual may be amended as the application is updated. To ensure you have the latest version, we recommend you download it from our website www.scs-sentinel.com**

B- DESCRIPTION

B1- Content / Dimensions

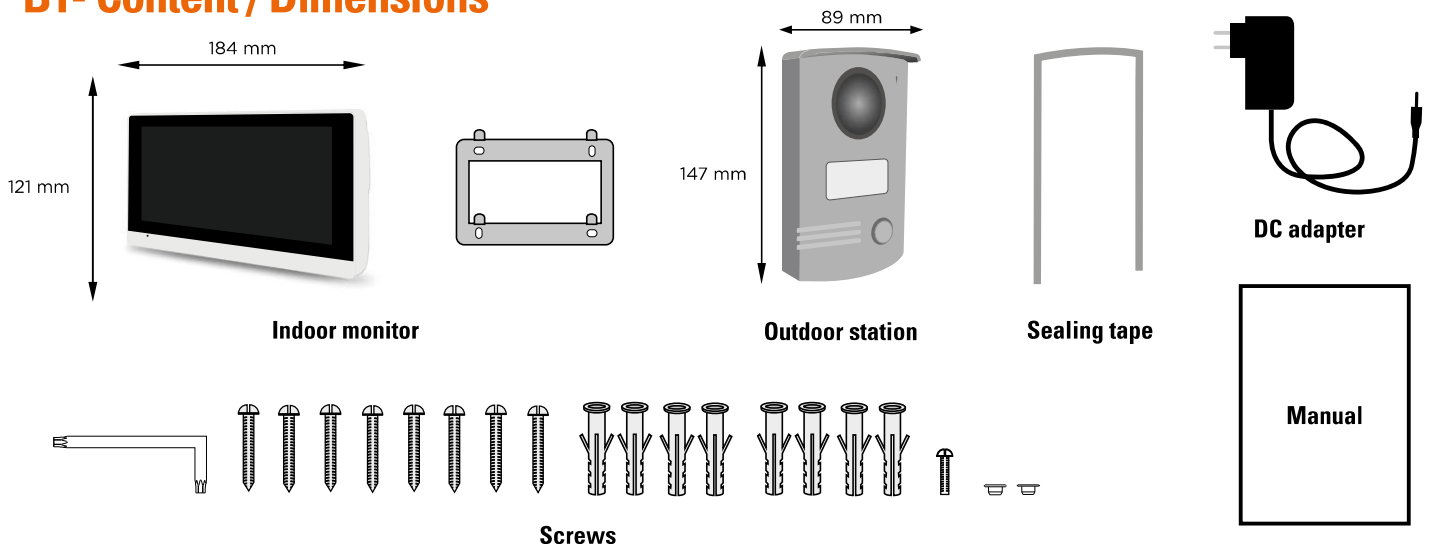

B2- Components

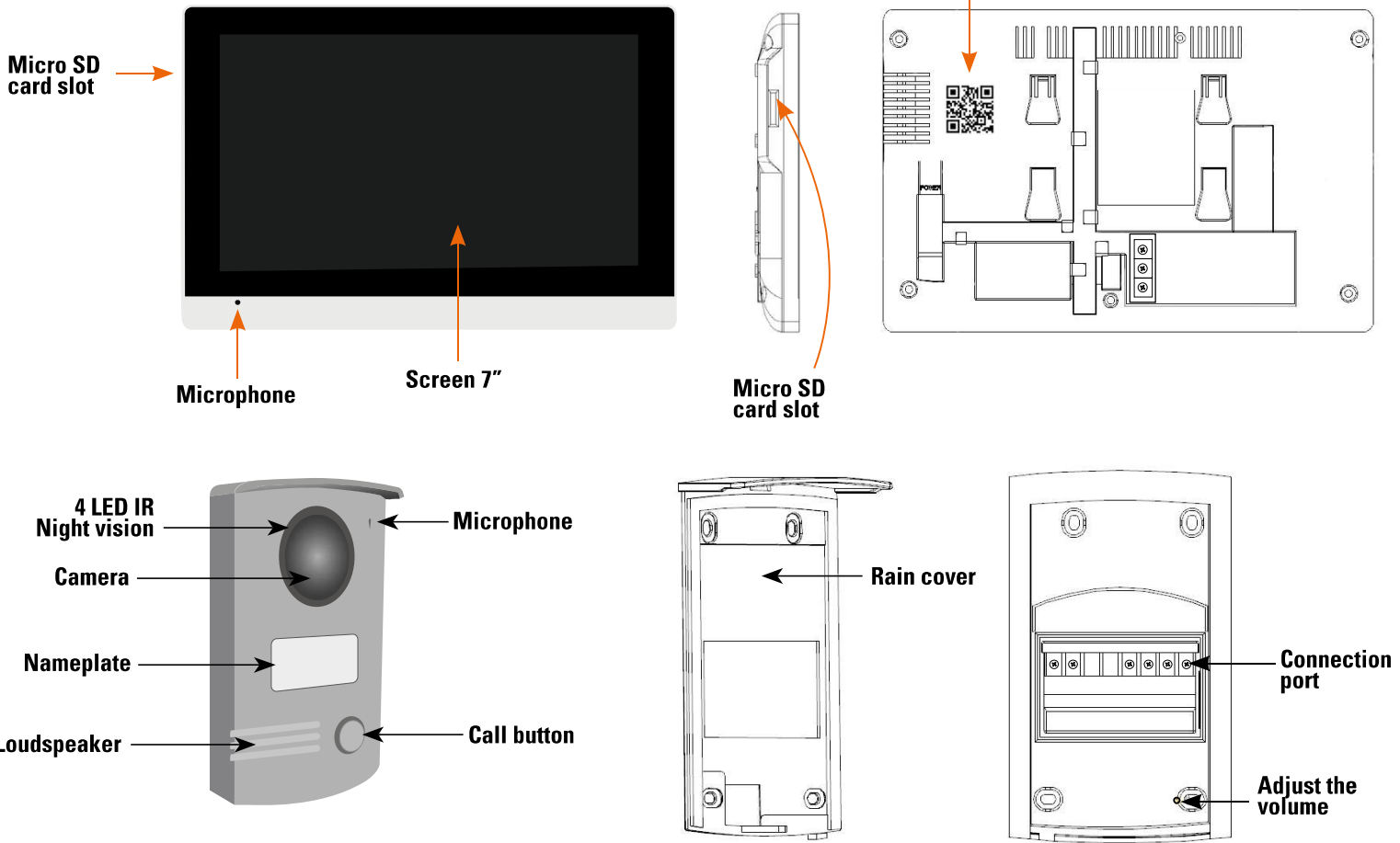

C- WIRING / INSTALLATION

C1- Installation

Indoor monitor

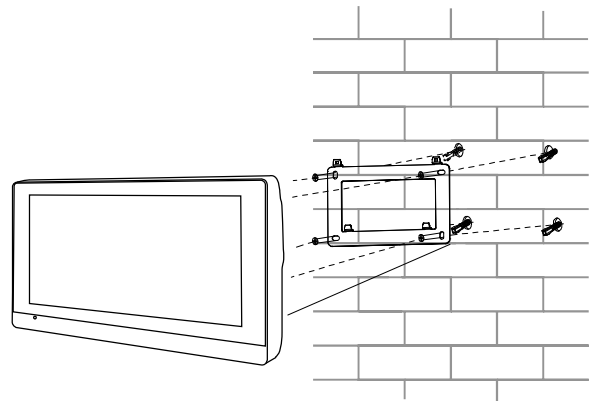
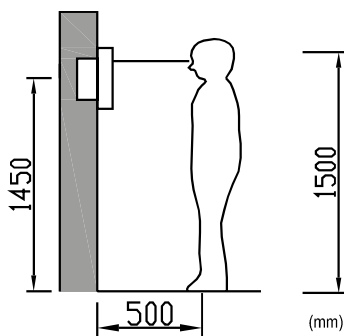

Outdoor station

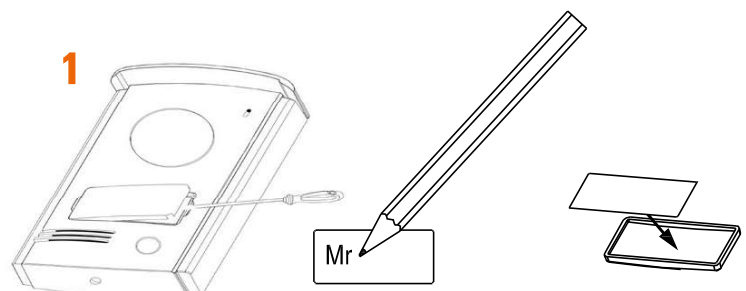
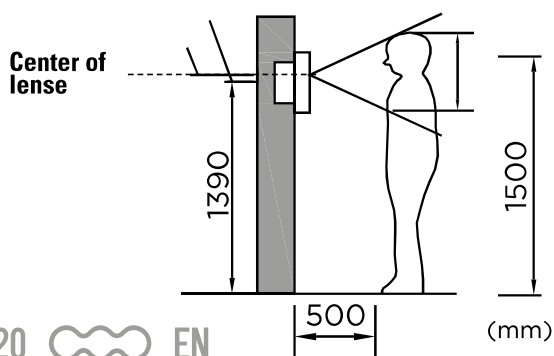

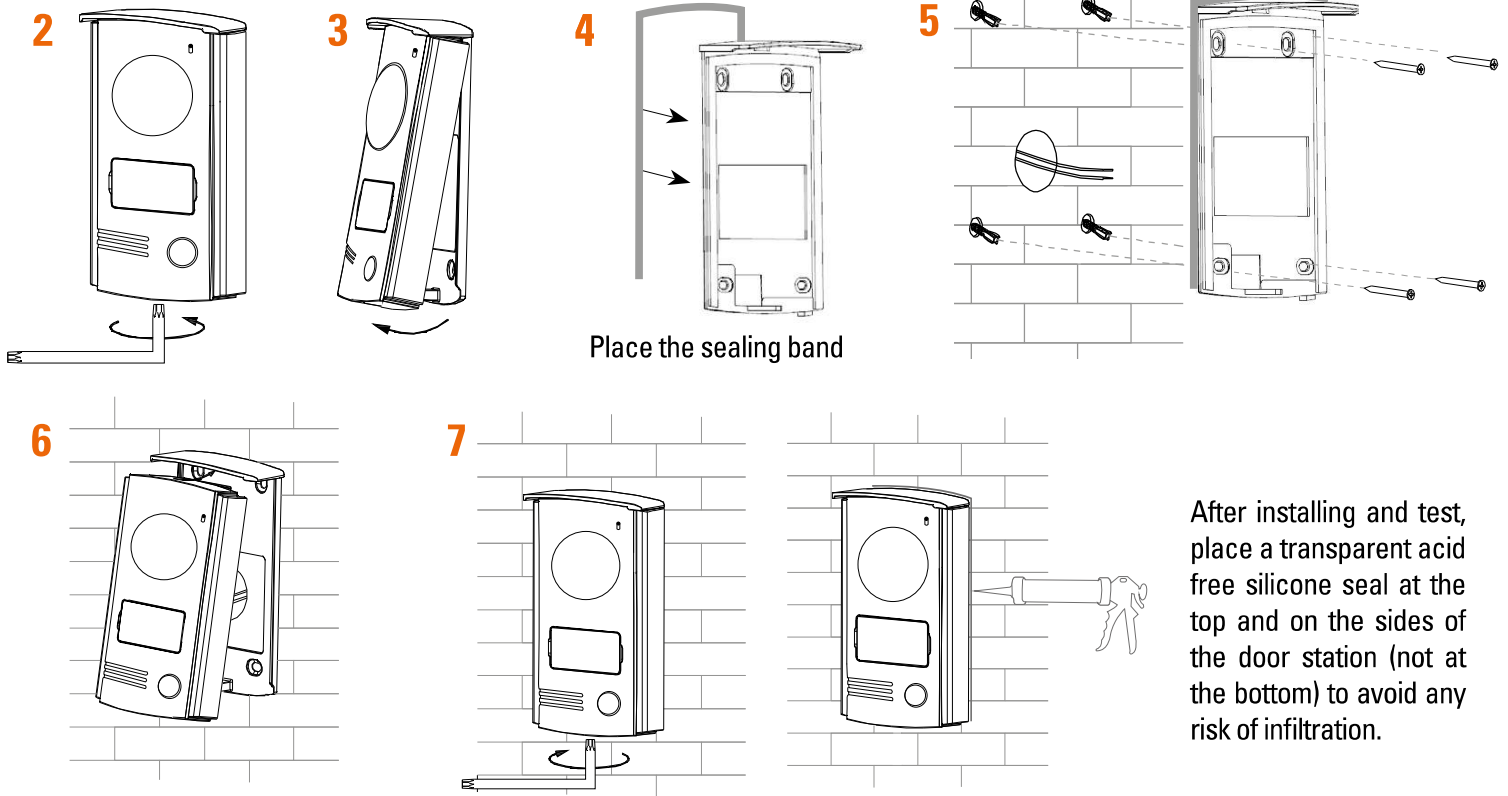

C2- Wiring diagram

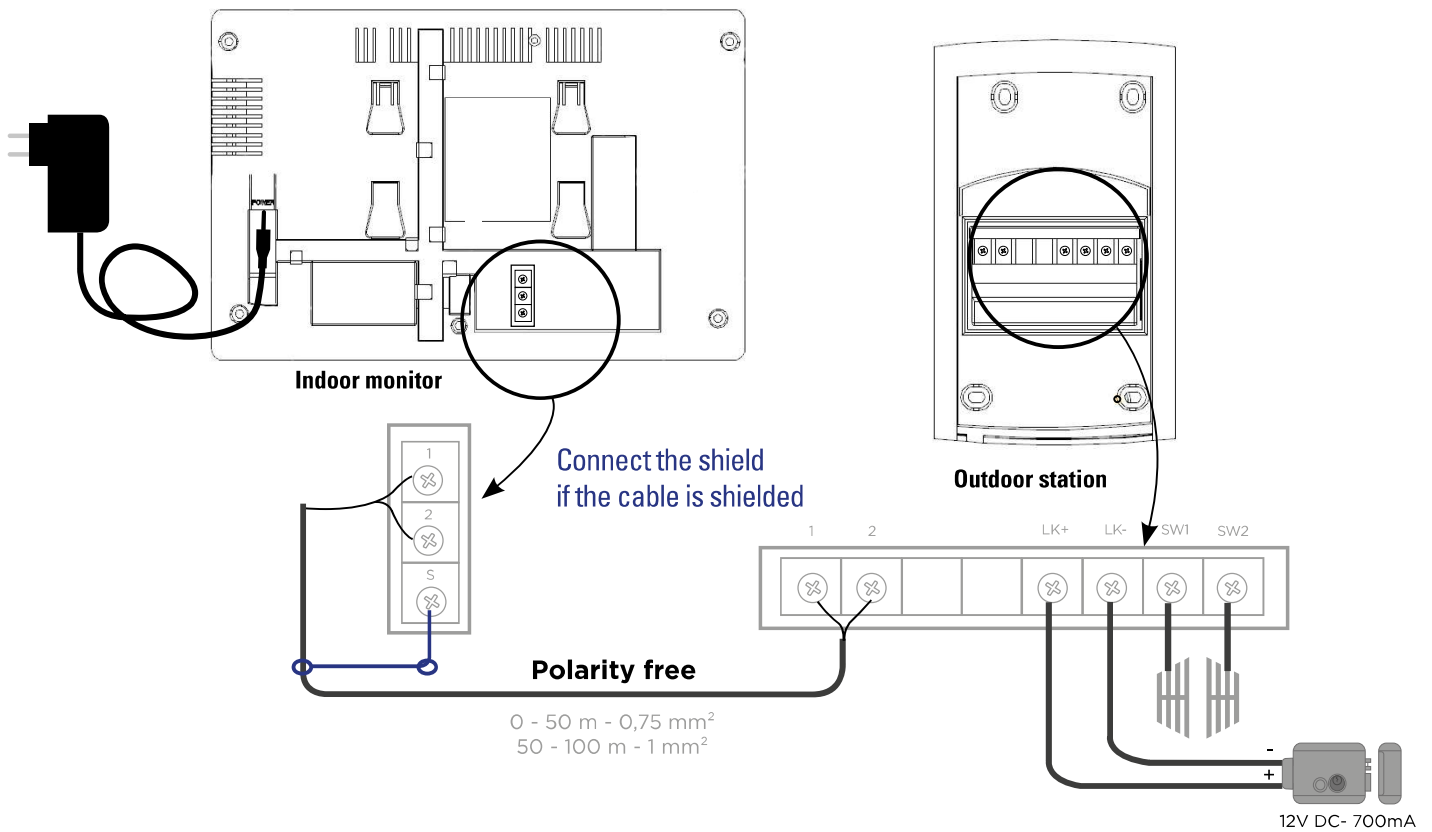

You can directly connect the monitor to your electrical panel via a 15V DC 0,8A (minimum) «rail DIN» transformer. Electrical knowledges are necessary, in this case. Please contact a professional.

BE CAREFUL : RESPECT THE POLARITY !
The wire with the gray strokes should be positioned on the +.
The wire with the writes must be positioned on the -.

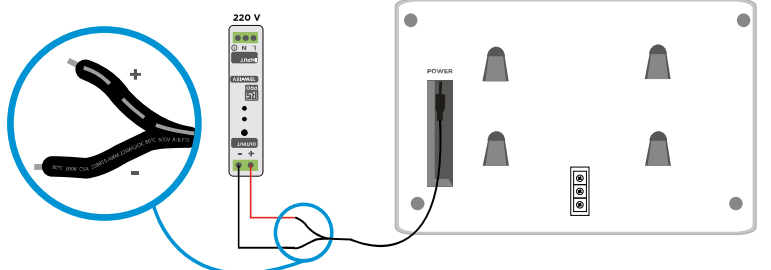

D- USE

D1- Call from the outdoor station

Remaining ringing time in seconds

- Settings
- Open the gate automation
- Release the electric lock
- Save a video
- Save a photo
- Talk
- Back to main screen (the missed call will not be displayed)

D2- Main screen

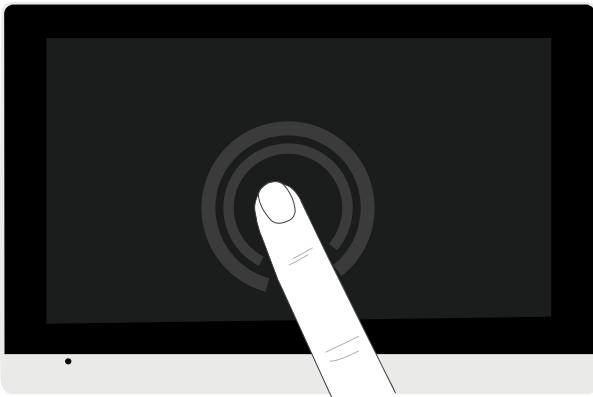

Exit the standby mode, only touching the screen.

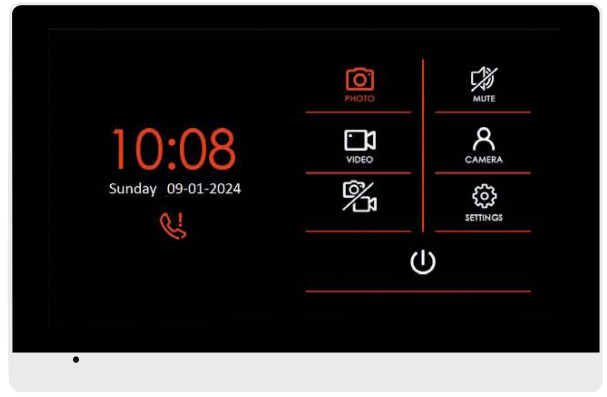



- Photos display
- Video display
- Select if the device takes a photo and/or video for each call
- Standby mode (the screen switch off automatically after 1 minute)
- Mute (this icon will be displayed on the top if the silent mode is selected)
- Camera view
- Settings

D3- Photos and videos display

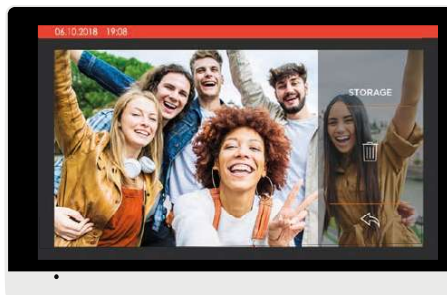
Photos



-  STORAGE Display photos of the device
-  Delete photo
-  Back to main screen

D4- Silent mode

Mute

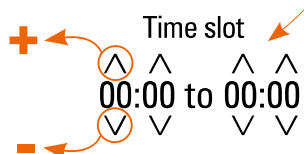
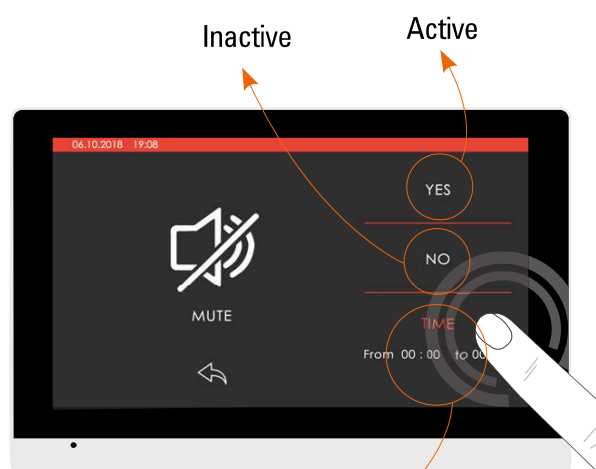
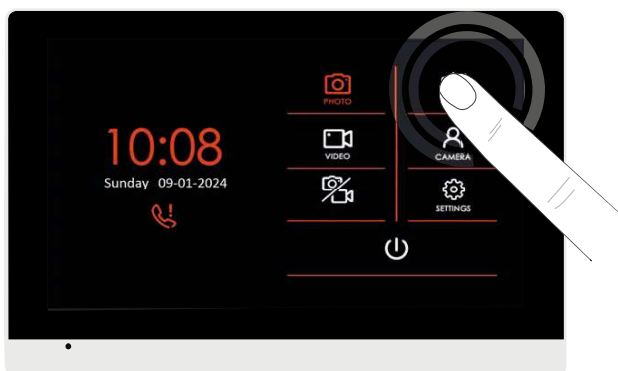

D5- Camera display

Camera

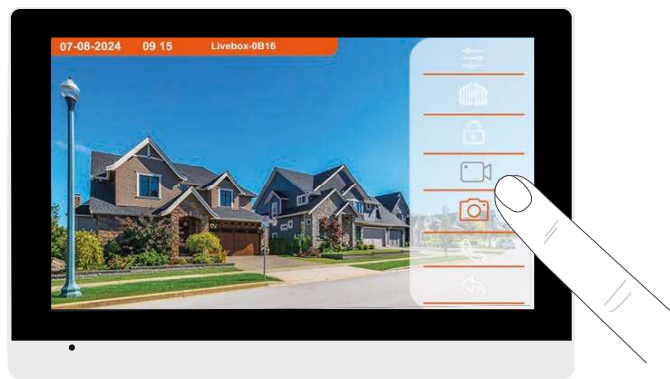
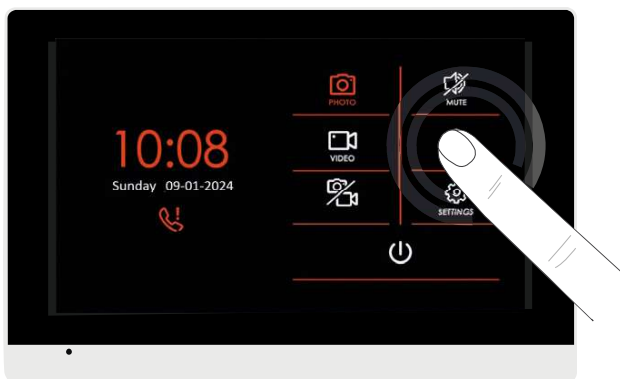

You can access the view of the door station from home by clicking on the camera icon

E- SETTINGS

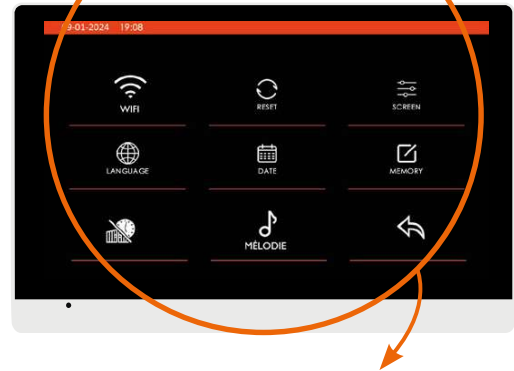
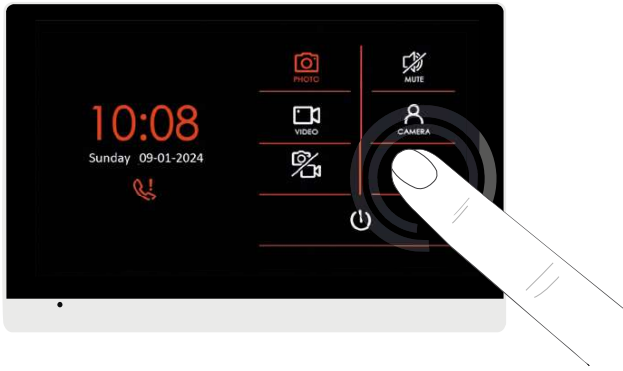

Wi-Fi	Reset	Screen setting
Set the language of the monitor	Set the date & time of the monitor	Memory setting page. Delete all images or videos on the Micro SD card, copy all images on the Micro SD card and format Micro SD card
Closing time of dry contact for the gate	Melody selection	Back to main screen

Wi-Fi

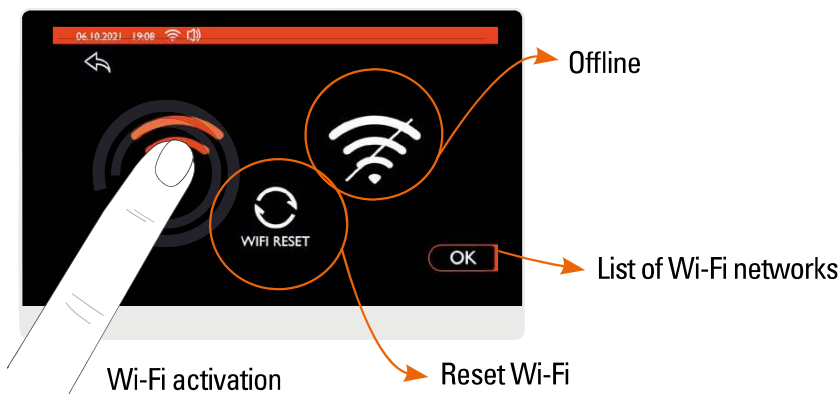



Melody



Ringtone at outdoor unit enabled



Ringtone at outdoor unit disabled

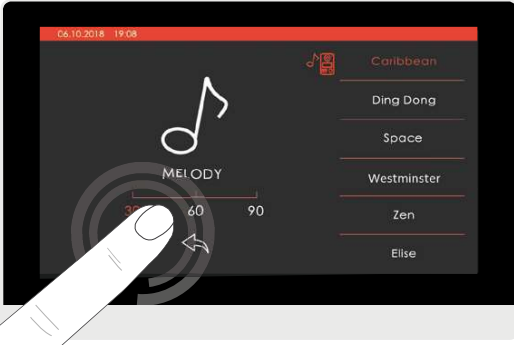

Choose ringing time :
30, 60 or 90 seconds

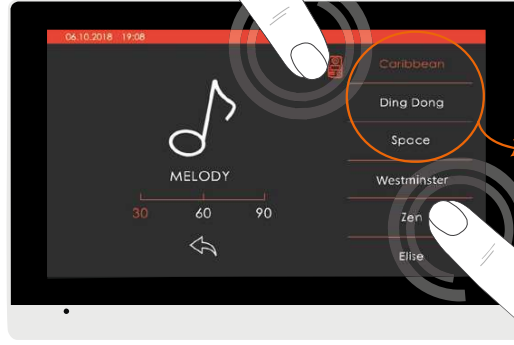

Set the melody

3 premium melodies
with possible ringtone
on the outdoor unit



Reset

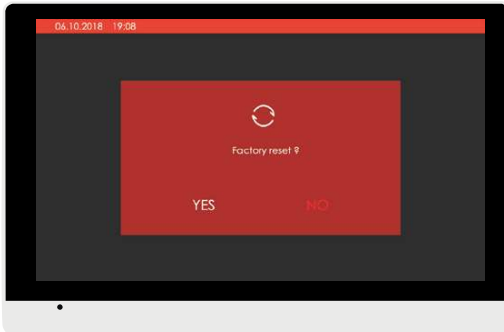

This function resets all the data
and all the device factory settings.



Brightness



Color



Contrast



Ring volume



Voice volume



Back
to main screen



Screen settings



Set the language

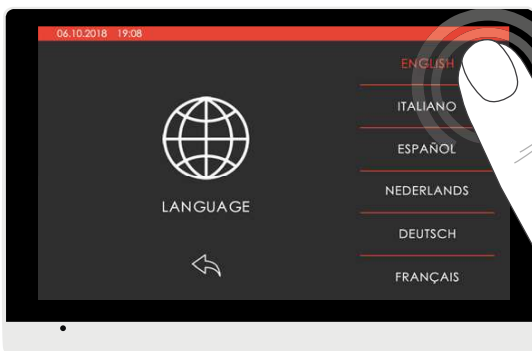



Set the date & time

Automatic date and time setting (If internet connection)

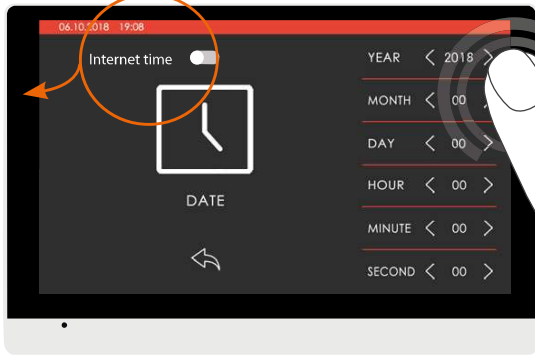

- <2023> +



Memory

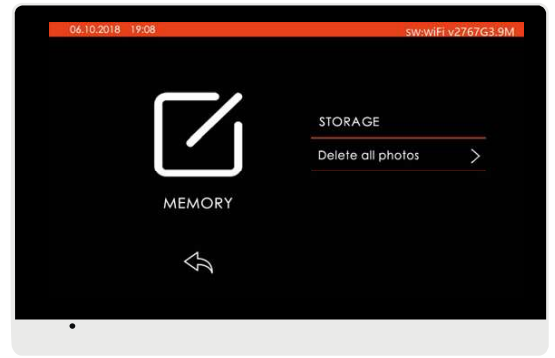

F- CONFIGURATION

Installing the app



iSCS Sentinel

To download the app, go on to the App Store or Play Store on your smartphone. Search for "iSCS Sentinel", then click on install.

1.



Once the download is complete, open the app and click on create my account.

2.



Enter your email address and password in the relevant boxes.

3.

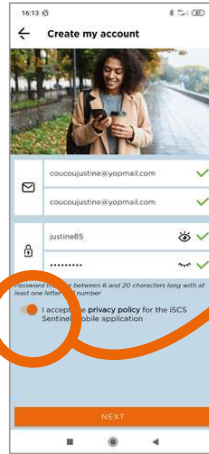

Click «next».



Please agree to the privacy policy before clicking next.

4.



Enter the validation code you received by email. Then confirm the account.

5.

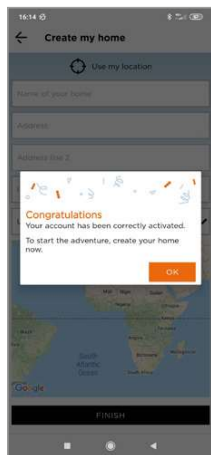

6.

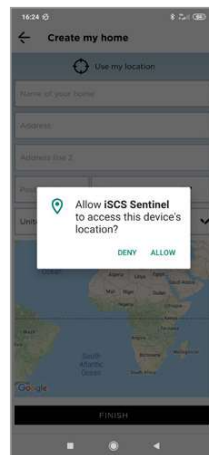

Click on allow.

7.

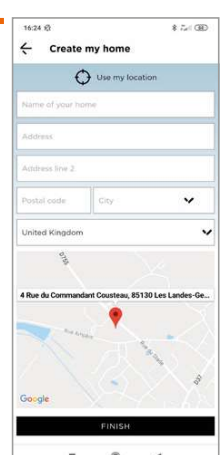

Enter all the information requested to create your home. Then click on finish.

Adding the monitor

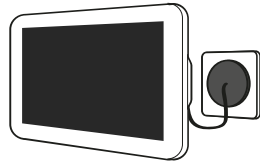
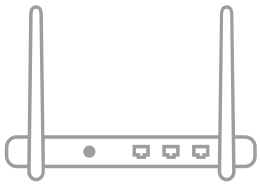

Plug in the power to the monitor and place it near your Wi-Fi router. Your phone must be connected to the same Wi-Fi network as your monitor and location must be enabled.



Some materials may reduce the Wi-Fi range.

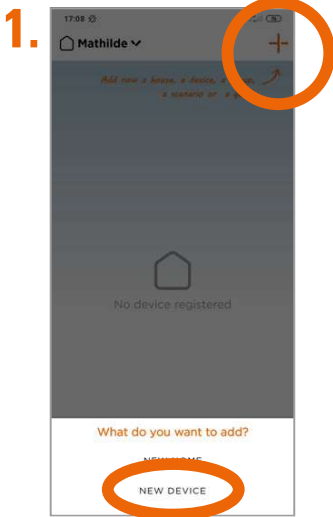
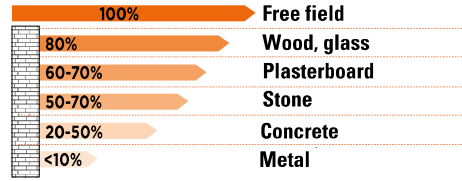

Click on "NEW DEVICE" to add your product.

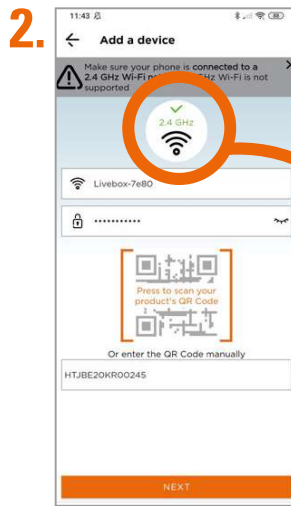

The network needs to be 2.4 GHz to work.



On the monitor, go to settings and then press the «WiFi» icon. Wait until the OK button is highlighted. Select your WiFi network and type in your password.

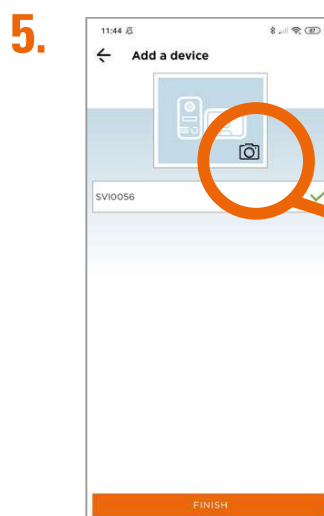
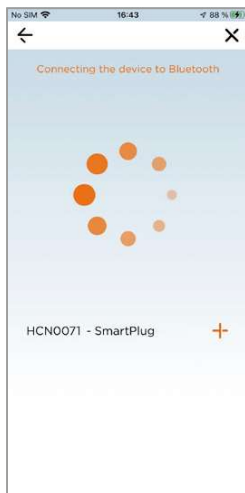

Enter a name for the product and the room in which it is located.

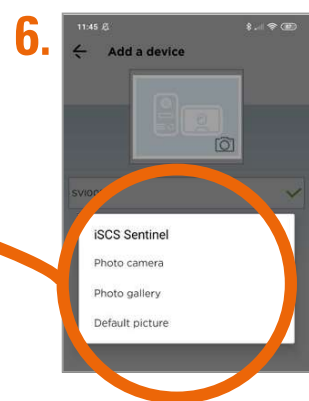

Add a profil picture from your camera, the gallery or select a picture by default (product visual or last motion capture).



If the device fails to connect to Wi-Fi, an error page is displayed.

Troubleshooting

1.



2.

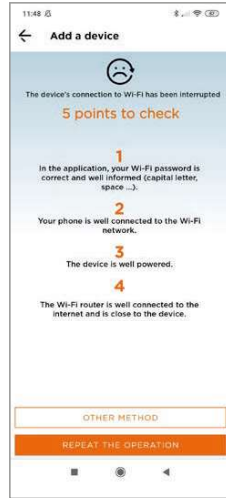

“repeat operation” takes you back to the second step.



If “repeat operation” does not work, click on “other method”

3.

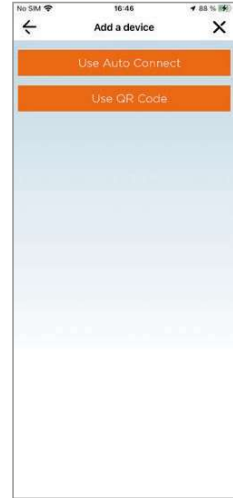

Check these five points.

Click on «QRCode»

4.

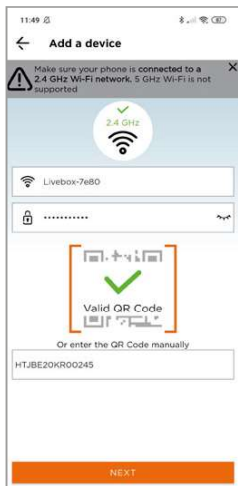

Check the information and click Next.

5.



Click on «show QR Code».

6.



Scan the QR code displayed with the board and then, after the sound signal, press «yes».



Loading begins and the three steps are completed.

This will take you to step 5 and 6 for changing the profile photo.

G- SETTING

Application settings

1.  Click on  to go to the app settings.

2.  **View my profile:** to change personal information



To add a home

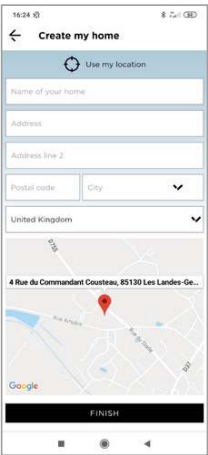

1.  Click on 

2.  Create a new home.

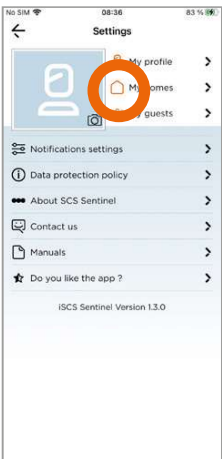
3.  Fill in the fields and click on "finish".

To remove a home

1.  Click on 

2.  Click on  to remove a home.

3. 

To edit a home

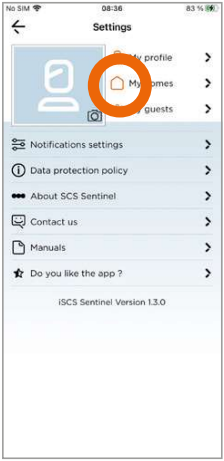
- 

Click on 
- 

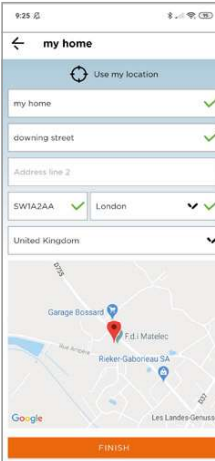
Edit the address.
- 

Notification settings

- 

Click on  to go to the notification settings.
- 

Click on « enable notification » to activate all notifications. Otherwise click on the desired notifications.

Using the app

- 

Click to speak.
- 

Take a photo on your phone.
- 

Activate full screen (tilt the phone).
- 

Record the video on your phone.
- 

Open or close the gate
- 

Release the electric lock

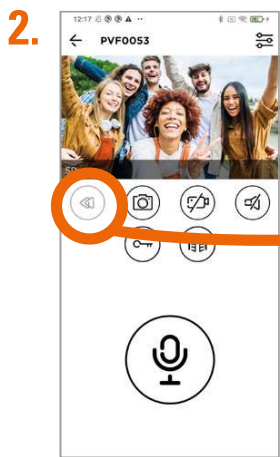

View what happened.



Save a video

save a photo



Click on  to change the product settings.



By default, the product will appear when the app is opened in the favourites list.

Click on  to add/remove the product from favourites.

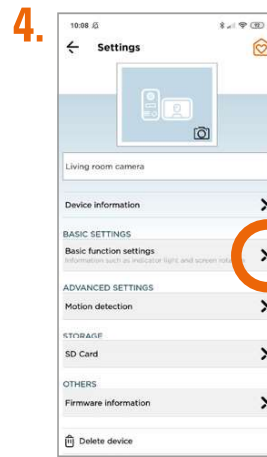

Click on basic settings.

SD card settings (if there is an SD card installed in your product)

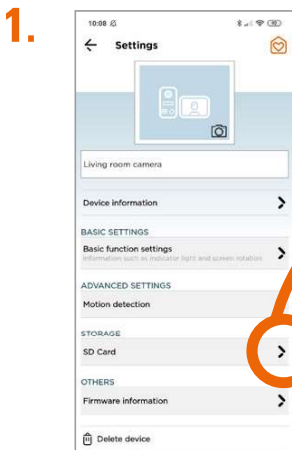

Click on "SD micro card" for the settings.

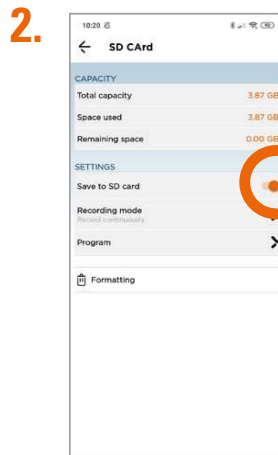

Click on "Record on SD micro card" to automatically save photos and videos on your product SD micro card.

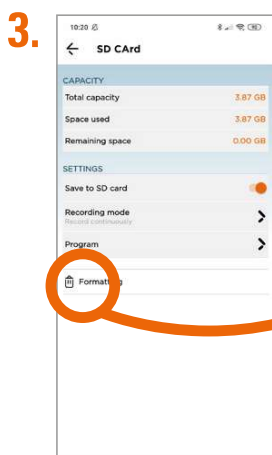

Press «Formatting» to reset your micro SD card.

Scenarios

A scenario is an action that follows a triggering event(s).

- 1 Select the trigger event(s). If you have several triggers, you could combine them together (AND) or dissociate them to carry out the action (OR).
- 2 Define the action(s) to carry out.
- 3 Register your scenario.

Then, the app will start the scenario action(s) when the trigger would be detected.

NEXT

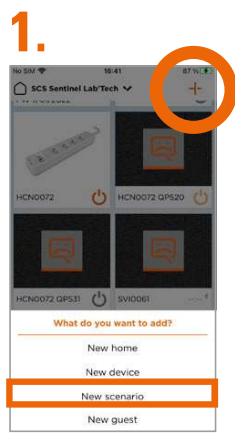

To select one or more trigger events (device, date/time or location) press +.

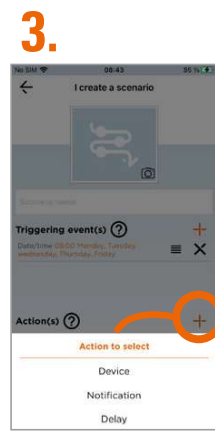

To select one or more actions (device, notification or delay) press +.

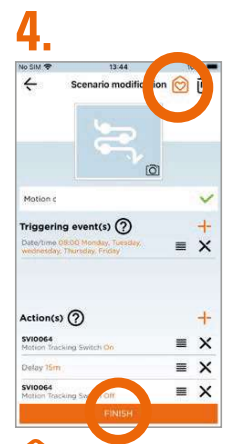

By default, the scenario will appear in the favorites list.



The scenario is activated

Activate the «actions» of the scenario without waiting for the «triggering events».

To add guests

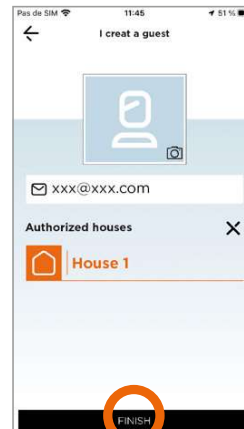
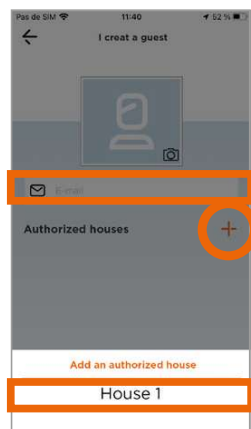
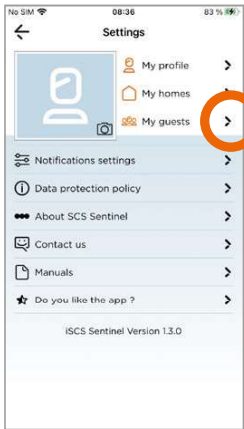

⚠ Via the iSCS Sentinel app, your guest can activate/deactivate the devices but cannot configure them.

Reset

To completely remove the device, you will need to delete it from the app.



H- TECHNICAL FEATURES

Indoor monitor

Input power	15V DC 0,8A
Screen	7 inch digital TFT LCD touch screen
LCD resolution	1024 x 600 px
Memory capacity (photos)	Built-in memory (14MB) when full the newest photo will automatically overwrite the oldest one
External memory capacity (photos or videos)	MicroSD card (4 GB - 32 GB class 4 - 10) (not supplied) MicroSD card must be formatted by monitor before using
Functioning frequency	2412 MHz - 2472 MHz
Maximum transmitted power	< 100mW
Wi-Fi	802 11b/g/n

Outdoor station

Material	Aluminium alloy
Angle view	100°
Night vision	IR LED
Operation temperature	-10°C /+ 50°C
Protection rating	IP55

Adapter

Model identifier	SH-7000-15-1A
Input voltage	110-240V AC
Input AC frequency	50/60Hz
Output voltage	15V DC
Output current	0.8A
Output power	12W
Average active efficiency	84.03%
Efficiency at low load (10%)	78.41%
No-load power consumption	0.084W

I- TECHNICAL ASSISTANCE

Online assistance



Any question ?

For an individual answer, use our online chat on our website www.scs-sentinel.com

J- WARRANTY





SCS Sentinel grants to this product a warranty period, beyond the legal time, as a sign of quality and reliability.

The invoice will be required as proof of purchase date. Please keep it during the warranty period. Carefully keep the barcode and the proof of purchase, that will be necessary to claim warranty.

K- WARNINGS

- Maintain a minimum distance of 10 cm around the device for sufficient ventilation.
- Be sure that the device is not blocked by paper, tablecloth, curtain or other items that would impede airflow.
- Keep matches, candles and flames away from the device.
- Product functionality can be influenced by a strong electromagnetic interference.
- This equipment is intended for private consumer use only.
- The appliance should not be exposed to dripping or splashing water; no objects filled with liquids, such as vases, should be placed near the appliance.
- The mains plug is used as disconnect device and shall remain readily operable during intended use.
- The monitor and the adapter must only be used indoors.
- Connect all the parts before switching on the power.
- Only connect your appliance using the provided adapter.
- Do not cause any impact on the elements as their electronics are fragile.
- Do not block the microphone.
- When installing the product, keep the packaging out of reach of children and animals. It is a source of potential danger.
- This appliance is not a toy. It is not designed to be used by children.

 Disconnect the appliance from the main power supply before service. Do not clean the product with solvent, abrasive or corrosive substances. Only use a soft cloth. Do not spray anything on the appliance.

 Make sure that your appliance is properly maintained and regularly checked in order to detect any sign of wear. Do not use it if a repair or adjustment is needed. Always call on qualified personnel.

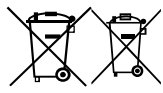
 Don't throw out of order products with the household waste (garbage). The dangerous substances that they are likely to include may harm health or the environment. Make your retailer take back these products or use the selective collect of garbage proposed by your city.

 Direct current

 Alternating current

 Model class II

 The monitor is for indoor use only

IP 55 : The outdoor unit is protected against harmful dust deposits and water jets from all direction.



L- DECLARATION OF CONFORMITY

Hereby, SCS Sentinel declares that this product complies with the essential requirements and other relevant provisions of Directive 2014/53/UE. The UE declaration of conformity may be consulted on the website : www.scs-sentinel.com/downloads.

INDICE

A- Precauzioni per l'uso	35
B- Specifiche.....	35
C- Cablaggio / Installazione	36
D- Utilizzo.....	38
E- Regolazioni	40
F- Configuration	42
G- Impostazione	45
H- Caratteristiche tecniche	49
I- Assistenza tecnica	50
J-Garanzia.....	50
K-Avvertenze	50
L-Dichiarazione UE di conformità	51

A- PRECAUZIONI PER L'USO

Il presente manuale costituisce parte integrante del prodotto. Queste istruzioni vengono fornite per vostra sicurezza. Siete pregati di leggerle con attenzione prima dell'uso e di conservarle per future esigenze di consultazione. Scegliere la posizione idonea. Verificare che non ci siano elementi che disturbano l'inserimento nel muro di viti e tasselli. Non collegare l'alimentazione prima di aver terminato e controllato l'installazione. L'installazione, i collegamenti elettrici e le regolazioni devono essere eseguiti a regola d'arte da un addetto qualificato e specializzato. L'unità di alimentazione deve essere installata in un luogo asciutto. Verificare che questo prodotto venga utilizzato esclusivamente per l'uso a cui è destinato.

La funzione di questo videotelefono è quella di identificare un visitatore, non deve essere utilizzato per la sorveglianza stradale. L'utilizzo di questo impianto deve essere conforme alla legge francese n° 78-17 del 6 gennaio 1978 relativa al trattamento dei dati, dei file e delle libertà. Spetta all'acquirente informarsi presso la CNIL sulle condizioni e le autorizzazioni amministrative necessarie per l'utilizzo al di fuori di un contesto strettamente personale. SCS Sentinel non può essere ritenuta responsabile in caso di utilizzo di questo prodotto al di fuori delle leggi e dei regolamenti in vigore. Questo prodotto funziona solo con l'applicazione iSCS Sentinel. L'applicazione è disponibile gratuitamente su PlayStore e AppStore. Può essere necessario aggiornare l'applicazione, ad esempio per risolvere bug, migliorare la funzionalità e fornire una migliore esperienza all'utente. È possibile attivare o disattivare gli aggiornamenti automatici dell'applicazione iSCS Sentinel nelle impostazioni di PlayStore o AppStore. Informazioni sul motivo dell'aggiornamento, sul suo impatto sulle prestazioni e sull'evoluzione delle funzionalità del prodotto o dell'applicazione, nonché sullo spazio di archiviazione utilizzato, sono indicate su PlayStore o AppStore per ogni aggiornamento.

In accordo con la normativa e la garanzia legale, la disponibilità dell'applicazione e dei suoi aggiornamenti è garantita per un periodo di 2 anni.

Il presente manuale può essere soggetto a modifiche man mano che l'applicazione viene aggiornata. Per essere sicuri di avere l'ultima versione, consigliamo di scaricarla dal nostro sito web www.scs-sentinel.com

B- SPECIFICHE

B1- Contenuto del kit

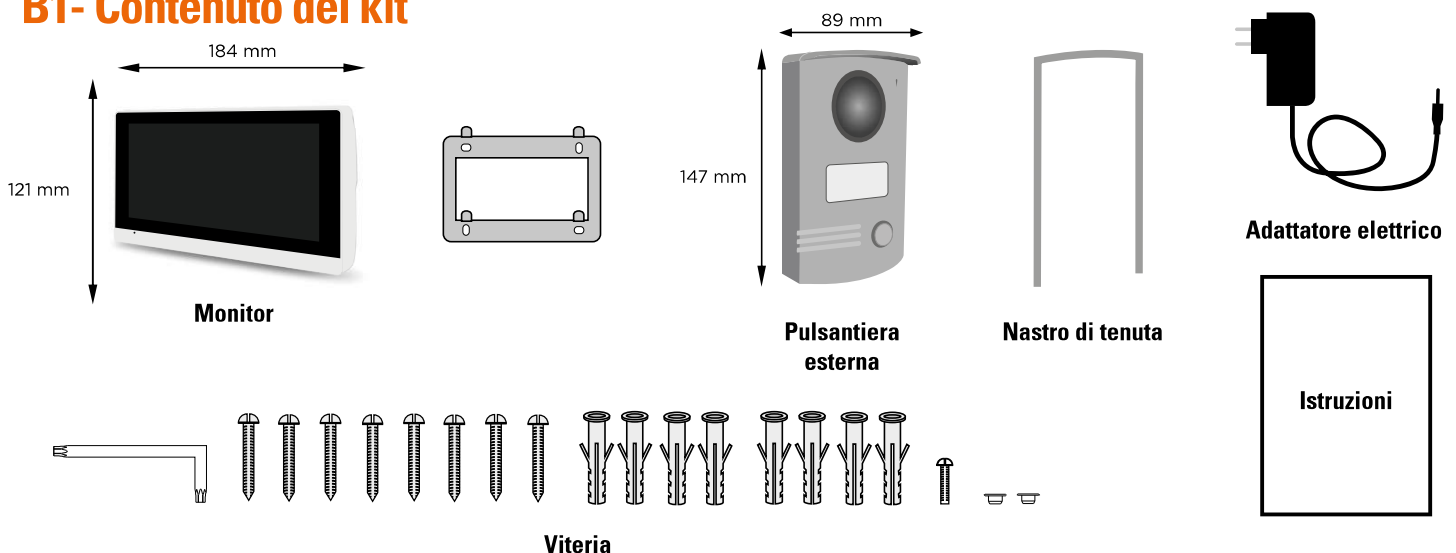

B2- Presentazione del prodotto

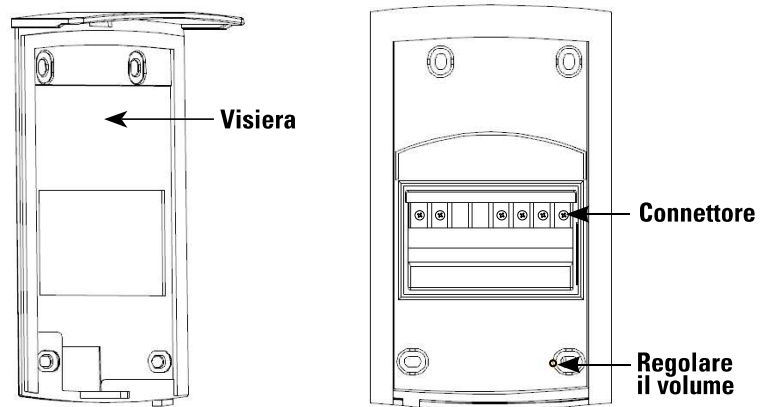
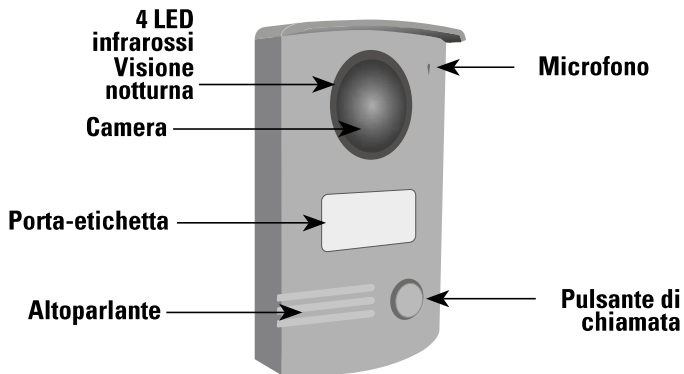
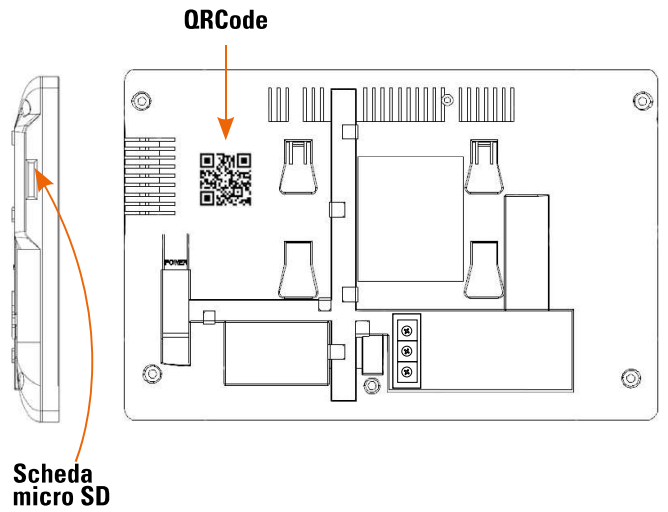
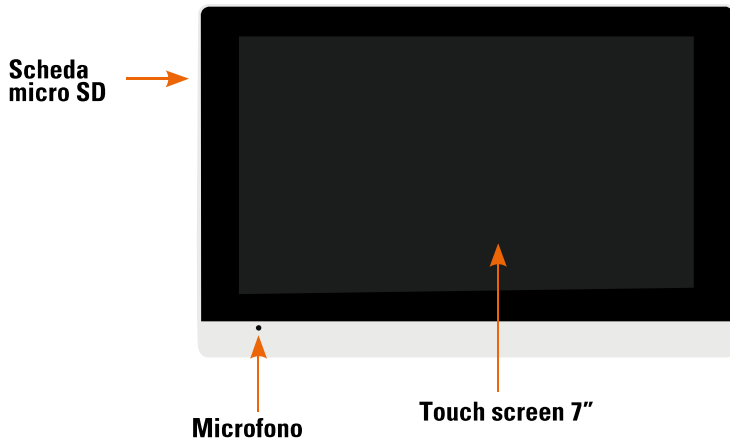

C- CABLAGGIO / INSTALLAZIONE

C1- Impianto

Monitor

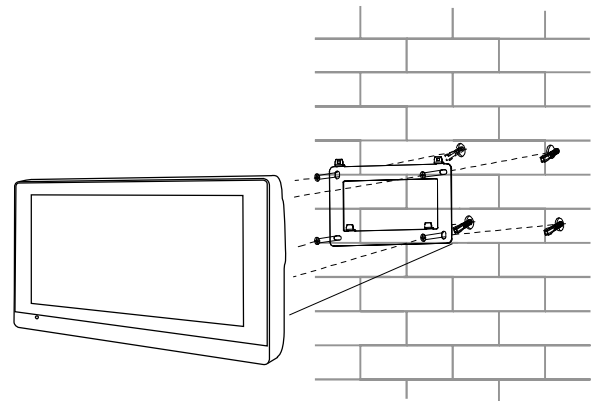
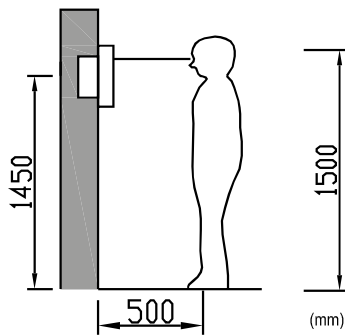

Pulsantiera esterna

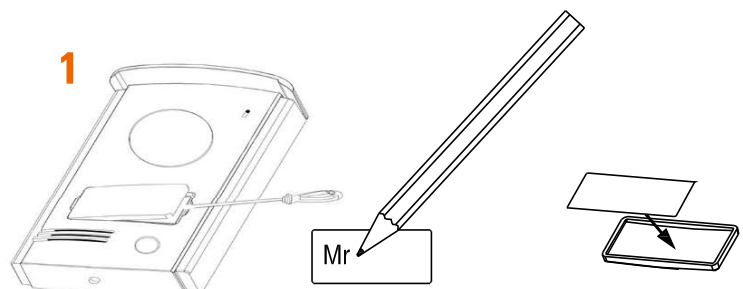
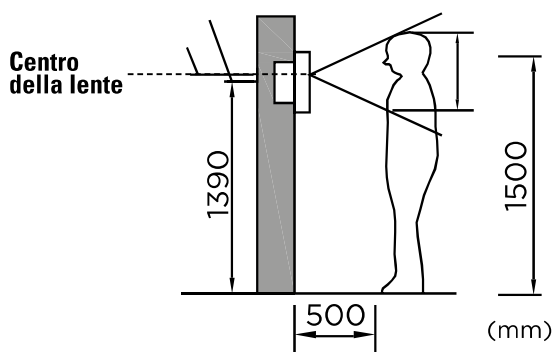

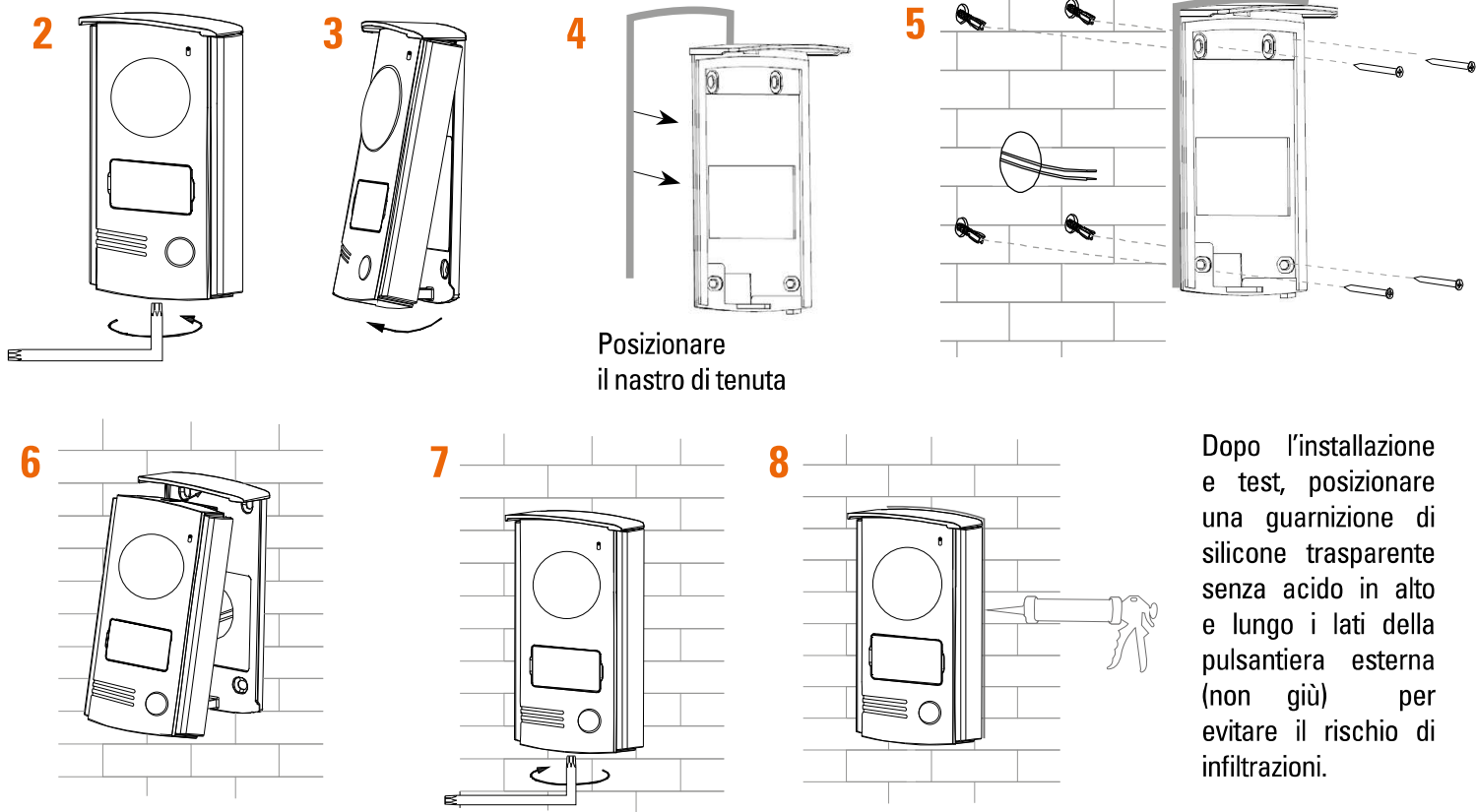

Dopo l'installazione e test, posizionare una guarnizione di silicone trasparente senza acido in alto e lungo i lati della pulsantiera esterna (non giù) per evitare il rischio di infiltrazioni.

C2- Schema di cablaggio

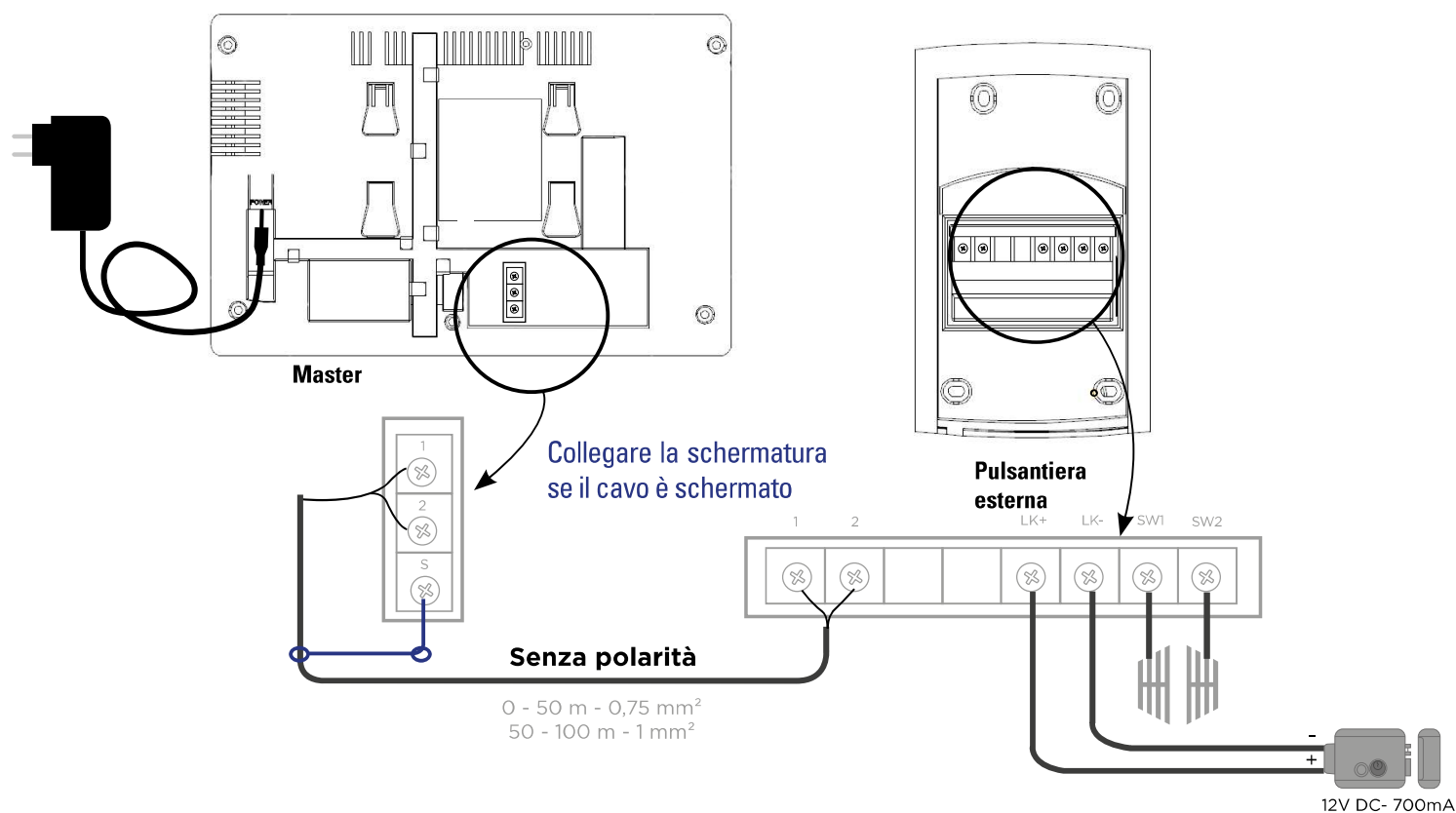

Avete la possibilità di connettere direttamente il monitor al vostro quadro elettrico attraverso uno trasformatore 15V DC 0,8A (minimo). Conoscenze elettriche che sono necessari, vi consigliamo di fare in questa caso chiamata a uno professionista.

ATTENZIONE : RISPETTARE LA POLARITÀ !
Il filo con i tratti grigi deve essere posizionato sul +. Il filo con le scritte deve essere posizionato sul -.

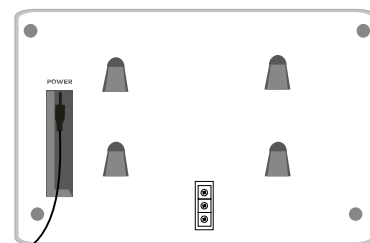

D- UTILIZZO

D1- Chiamata dalla pulsantiera esterna







Tempo di squillo rimanente in secondi

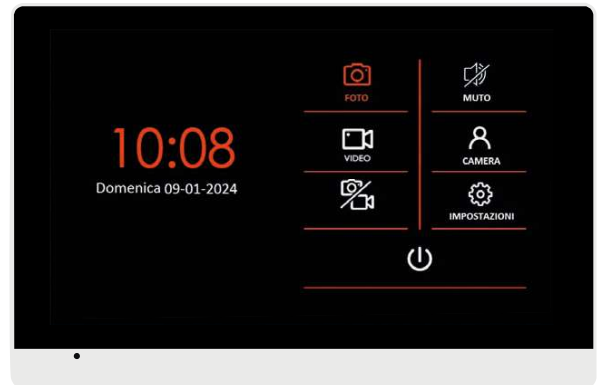
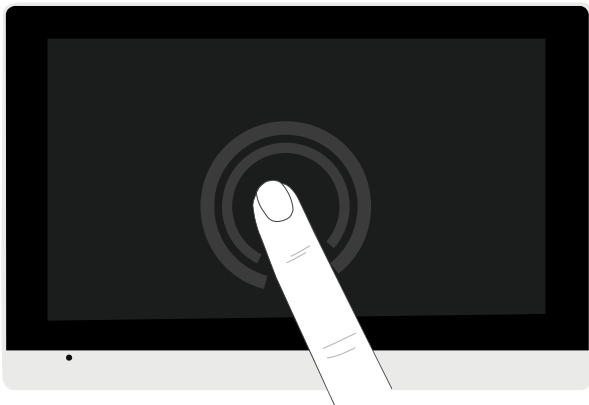

- Schermo di regolazioni
- Azionamento automatismo del cancello
- Azionamento apriporta
- Registrazione video
- Registrazione foto
- Rispondere / Riagganciare
- Ritorno allo schermo principale (la chiamata persa non sarà segnalata)

D2- Schermo principale



Per cescire della condizione de riposo, toccare lo schermo

-  Visualizzazione delle foto
-  Visualizzazione delle video
-  Scegliere se il dispositivo scatta una foto e(o) un video ad ogni chiamata
-  Oscuramento dello schermo (lo schermo si spegne automaticamente dopo 1 minuto)

-  Modo silenzioso (questa icona apparirà nella parte superiore dello schermo se viene selezionata la modalità silenziosa)
-  Vista Camera
-  Regolazioni

D3- Visualizzazione foto e video

Foto

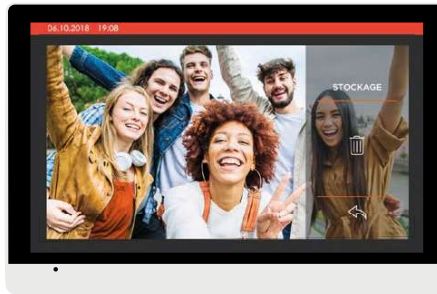

-  Visualizzare le foto
-  Eliminare la foto
-  Ritorno allo schermo principale

D4- Modo silenzioso

Modo silenzioso

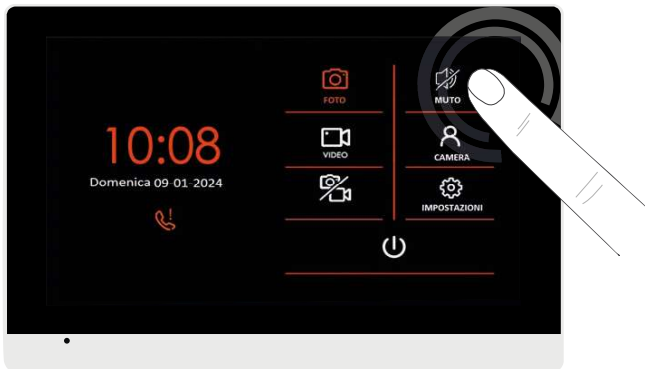

Fascia oraria
+ 00:00 alle 00:00 -

D5- Visualizzazione camera

Camera

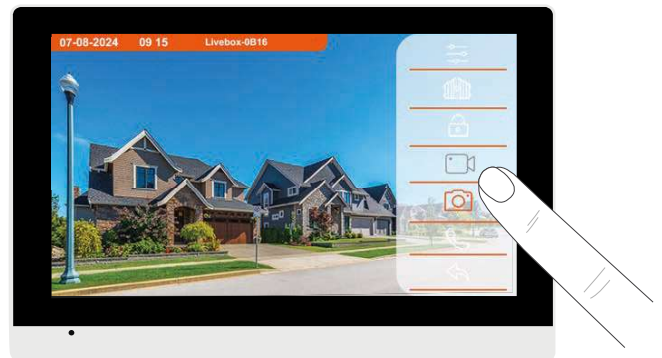
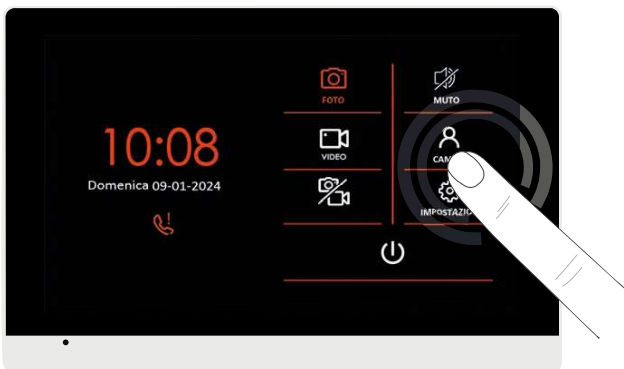

È possibile accedere alla vista del posto esterno da casa facendo clic sull'icona della telecamera

E- REGOLAZIONI

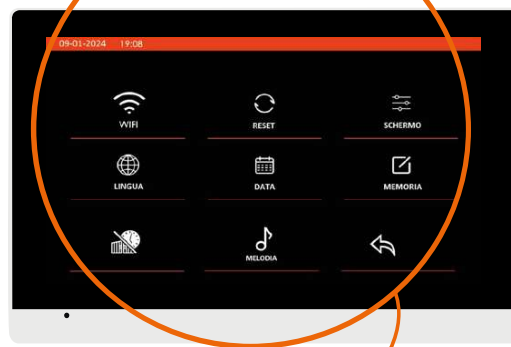
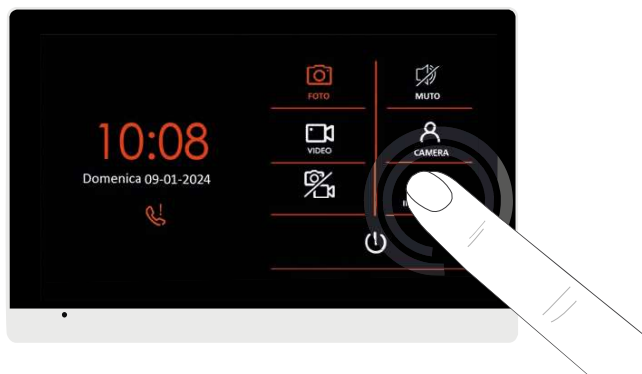

Wi-Fi



Reset

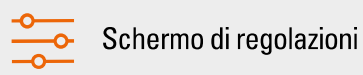

Schermo di regolazioni



Scelta della lingua

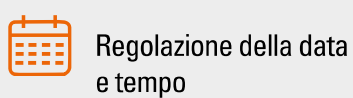

Regolazione della data e tempo

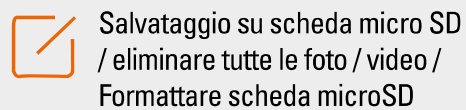

Salvataggio su scheda micro SD / eliminare tutte le foto / video / Formattare scheda microSD

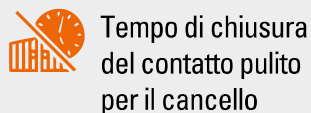

Tempo di chiusura del contatto pulito per il cancello

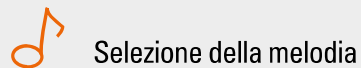

Selezione della melodia

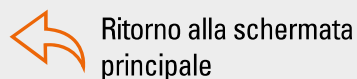

Ritorno alla schermata principale

Wi-Fi

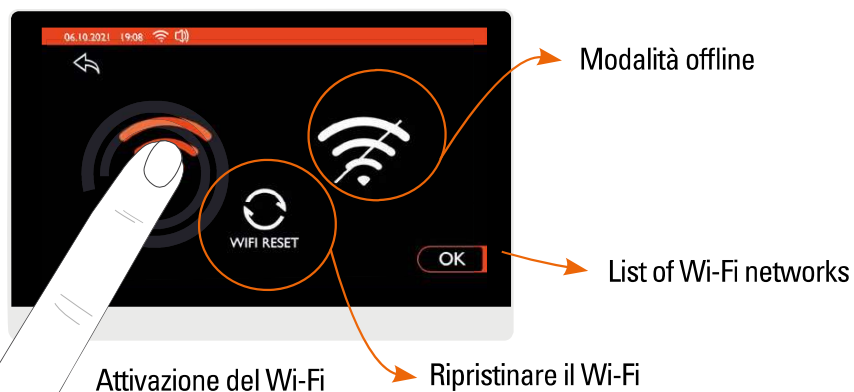

Melodia



Ritorno di chiamata attivato

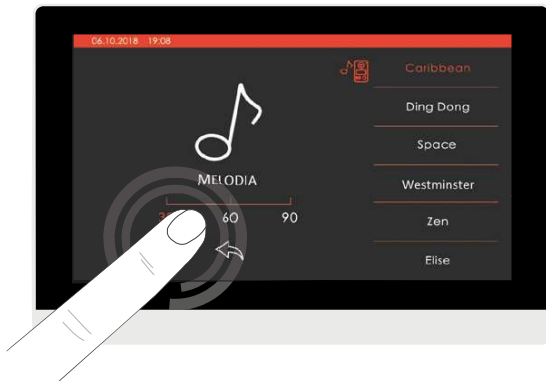

Scegliere la durata della chiamata
30, 60 o 90 secondi



Ritorno di chiamata disattivato

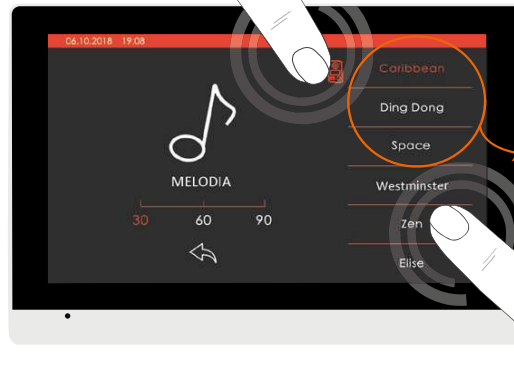

3 melodie premium
con ritorno di
chiamata possibile
sulla pulsantiera
esterna

Selezionare la
melodia



Reset

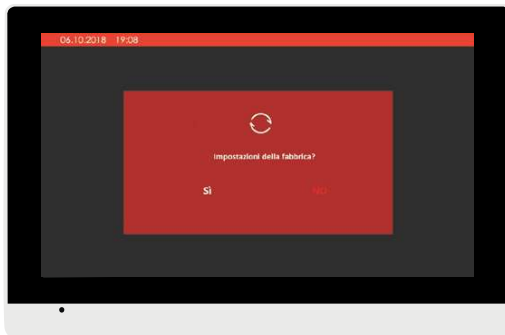

Questa funzione consente di ripristinare tutti i dati e tutte le impostazioni iniziali dell'apparecchio.



Regolazioni dello schermo



Luminosità



Colore



Contrasto



Volume della chiamata



Volume voce



Ritorno allo schermo
principale



Selezione della lingua





Regolazione della data

Impostazione automatica di data e ora (Se la connessione a Internet)

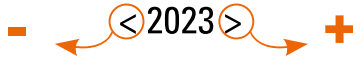
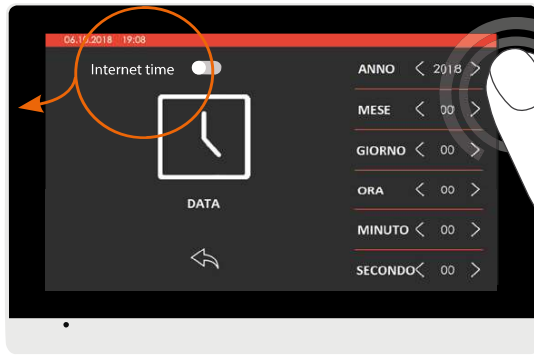

Salvataggio su scheda SD



F- CONFIGURAZIONE

Installazione dell'applicazione



iSCS Sentinel

Per scaricare l'applicazione, effettuare il login da App Store o Play Store del proprio smartphone. Cercare «iSCS Sentinel», poi cliccare su Installare.

1.



Quando il download è completo, aprire l'applicazione e cliccare su «creare il mio conto».

2.



Inserire l'indirizzo e-mail e la password nelle caselle corrispondenti.

3.

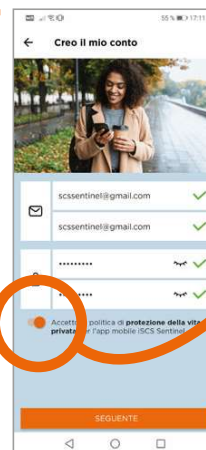

Premere il tasto seguente.



Si prega di accettare l'informativa sulla privacy prima di cliccare su seguente.

4.



Compilare il codice di convalida ricevuto via e-mail. Poi confermare l'account.

5.

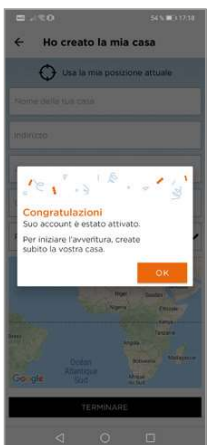

6.

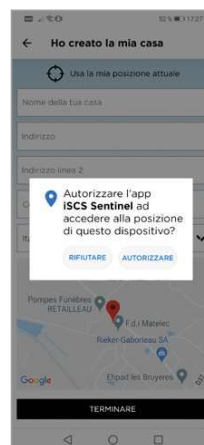

Premere AUTORIZZARE.

7.



Inserire tutte le informazioni necessarie per creare la propria casa. Poi cliccare su Terminare.

Aggiunta della monitor

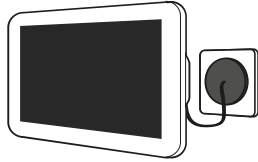
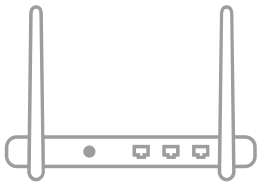

Collegare il monitor all'alimentazione e posizionarlo vicino al router Wi-Fi. Il telefono deve essere collegato alla stessa rete Wi-Fi del monitor e la localizzazione deve essere abilitata.

Alcuni materiali possono ridurre la portata del Wi-Fi.

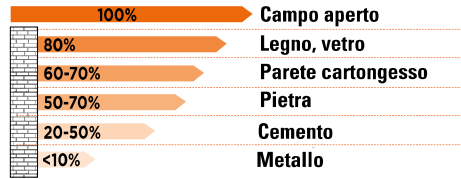

Premere **+** poi «**NUOVO DISPOSITIVO**» per aggiungere il prodotto



Inserire la chiave Wi-Fi, scansionare il codice QR sul retro del monitor o inserire il codice manualmente.

La rete deve essere in 2,4 GHz per funzionare

2.4 GHz



Sul monitor, andare su impostazioni e premere l'icona «Wi-Fi». Attendere finché non viene evidenziato il pulsante OK. Selezionare la rete Wi-Fi e digitare la password.

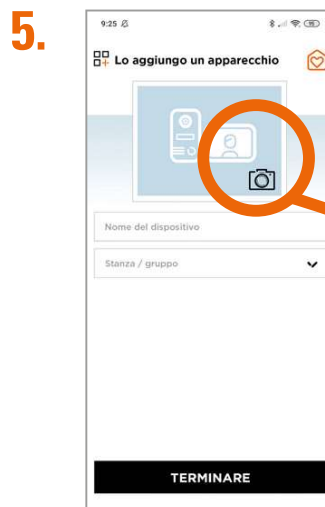
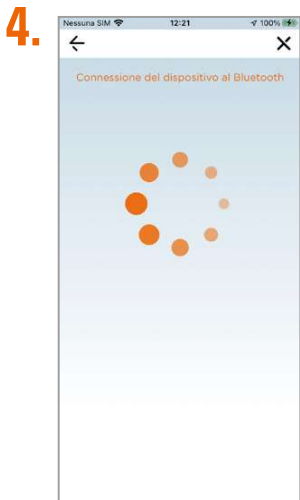

Inserire un nome per del prodotto e la stanza in cui si trova.

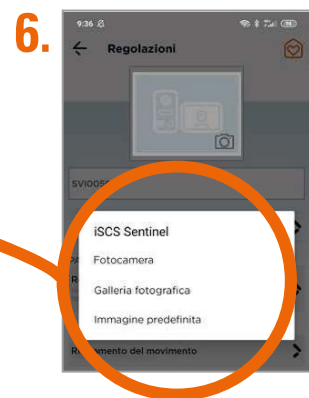

Aggiungere una foto del profilo del prodotto, galleria o selezionare un'immagine predefinita (visuale del prodotto o ultima acquisizione del movimento.)



Se il dispositivo non riesce a connettersi al Wi-Fi, una pagina di errore appare.

Risoluzione dei problemi

1.



2.



Clickando su «ripetere l'operazione»: si ritorna al 2° passo.



Se «ripetere l'operazione» non funziona, premere «altro metodo».

3.

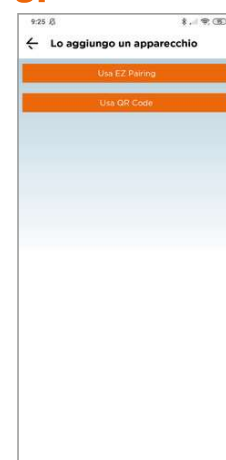

Controllare questi 5 punti.

Premere «QRCode»

4.



Controllare le informazioni e cliccare su seguente.

5.



Clickate su «mostra codice QR».

6.



Eeguire la scansione del codice QR visualizzato con la scheda e poi, dopo il segnale acustico, premere «sì».



Il caricamento viene effettuato ed i 3 passaggi sono convalidati. **Si ritorna ai passi 5 e 6 per modificare l'immagine del profilo.**

G- IMPOSTAZIONE

Impostazioni



Premere  per accedere alle impostazioni dell'applicazione.



Visualizza il mio profilo:
Modificare i dati personali se necessario.

Per aggiungere una casa



Cliccare 

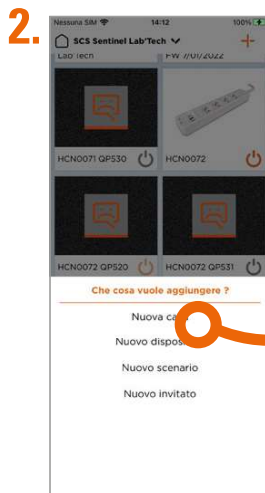

Creare una nuova casa.

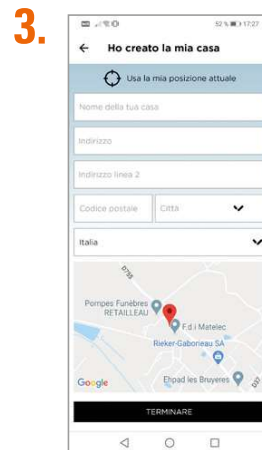

Compilare i campi e premere «TERMINARE».

Per cancellare una casa



Premere 

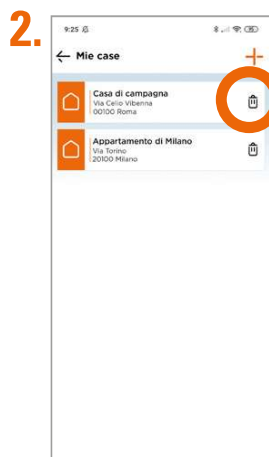

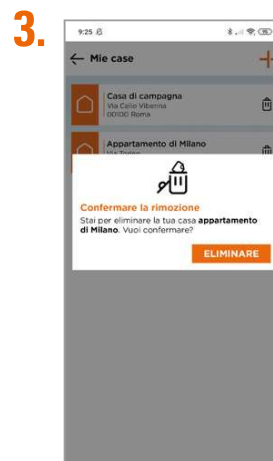

Premere  per cancellare una casa.



Per modificare una casa

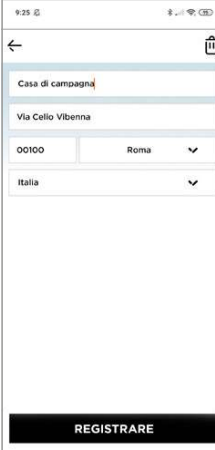

- 

Premere 
- 

Modificare l'indirizzo.
- 

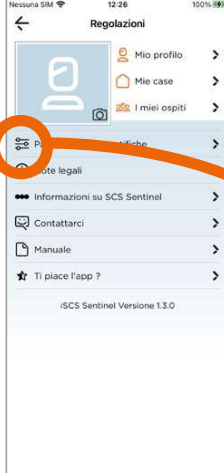
Impostazioni delle notifiche

- 

Premere  per accedere alle impostazioni delle notifiche.
- 

Premere Attiva notifiche per attivare tutte le notifiche. Altrimenti, premere le notifiche desiderate.

Utilizzo dell'applicazione

- 

Premere per parlare.

Attivare l'ascolto.
- 

Riprendere la foto nel telefono.

Attivare lo schermo intero (muovere il telefono).

Riprendere il video nel telefono.
- 

Rilasciare la serratura elettrica

Aprire o chiudere il cancello

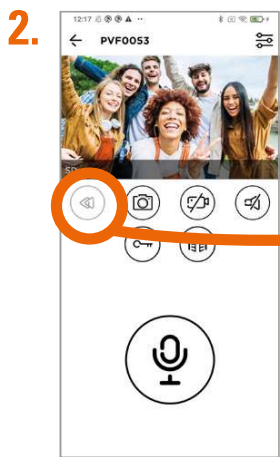

2. Visualizzare cosa è successo.



Salvare un video

Salvare una foto



3. Premere per modificare le impostazioni del prodotto



4. Di default, la telecamera apparirà nell'elenco dei preferiti non appena l'applicazione viene aperta. Premere per aggiungere/rimuovere la telecamera dai preferiti.

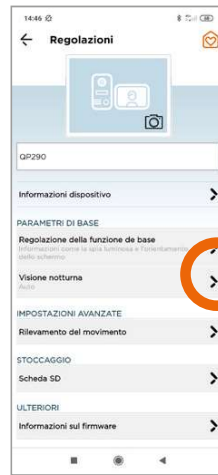

Premere impostazione delle funzioni di base.

Impostazioni della scheda SD (solo se presente del prodotto)



1. Premere «scheda micro SD» per accedere alle impostazioni.



2. Premere «Salva su scheda micro SD» per salvare automaticamente foto e video sulla scheda micro SD del prodotto.

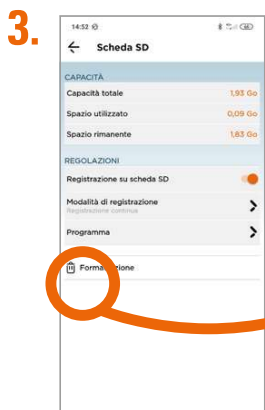

3. Premere «Programmare» per programmare i periodi di registrazione sulla scheda SD.

Scenari

Uno scenario è un'azione che segue uno o più eventi scatenanti:

1

Selezionare/ eventi trigger. Se avete parecchi grilletti, voi con la scelta fra combinarli insieme (E) o dissociarli per realizzare l'azione (O).

2

Definiscilo/le azioni da eseguire.

3

Salva il tuo copione.

Successivamente, l'applicazione avvierà il/le azioni(e) dello scenario quando avrà individuato un trigger.

1.



2.



Per selezionare uno o più eventi di attivazione (dispositivo, data/ ora o località), premere +.

3.



Per selezionare una o più azioni (dispositivo, notifica o ritardo) premere +.

4.

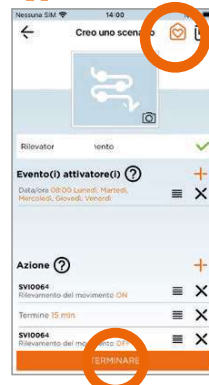

Di default, lo scenario apparirà nella lista dei preferiti.



Lo scenario è attivato.

Attivare le «azioni» dello scenario senza attendere gli «eventi scatenanti».

Aggiungere ospiti

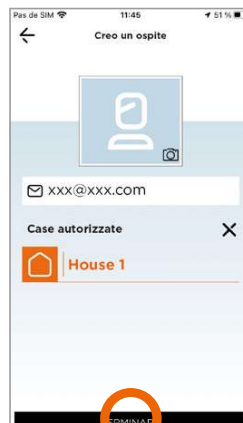

⚠ Tramite l'applicazione iSCS Sentinel, l'ospite può attivare/disattivare i dispositivi ma non può impostarli.

Reset

Per rimuovere completamente la telecamera, è necessario cancellarla nell'applicazione.



H- CARATTERISTICHE TECNICHE

Monitor

Alimentazione	15V DC 0,8A
Schermo	Schermo touchscreen 7" TFT LCD
Risoluzione dello schermo LCD	1024 x 600 px
Memoria interna (foto)	14 Mo. Quando la memoria è piena, la nuova foto sovrascrive automaticamente la foto più vecchia.
Salvataggio su scheda SD esterna (foto/video)	4 Go - 32 Go classe 4 - 10 (non fornite) È necessario formattare la scheda micro SD prima di utilizzarla
Frequenza operativa	2412 MHz - 2472 MHz
Potenza massima di trasmissione	< 100mW
Wi-Fi	802 11b/g/n

Pulsantiera esterna

Materiale	Leghe di alluminio
Campo di ripresa	100°
Visione notturna	LED IR
Temperatura di esercizio	-10°C /+ 50°C
Indice de protezione	IP55

Adattatore elettrico

Riferimento del modello	SH-7000-15-1A
Tensione di ingresso	110-240V AC
Frequenza del CA dell'entrata	50/60Hz
Tensione di uscita	15V DC
Corrente di uscita	0.8A
Potenza di uscita	12W
Rendimento medio in modo attivo	84.03%
Rendimento a basso carico (10%)	78.41%
Consumo elettrico a vuoto	0.084W

I- ASSISTENZA TECNICA

Assistenza telefonica

I tecnici del servizio post-vendita sono disponibili al numero :



0039 01119620971

In caso di malfunzionamento del prodotto durante l'installazione o pochi giorni dopo la stessa si invita a contattare il servizio clienti rimanendo in prossimità del prodotto in modo da consentire ai nostri tecnici di diagnosticare subito l'origine del problema.

Chat online



Una domanda ?

Per una risposta personalizzata, utilizzare la nostra chat online su nostro sito web www.scs-sentinel.com

J- GARANZIA



SCS Sentinel concede a questo prodotto una garanzia superiore alla durata legale, in garanzia di qualità e affidabilità.

È obbligatorio conservare una prova d'acquisto per tutta la durata della garanzia.

Conservare accuratamente sia il codice a barre che lo scontrino :
vi saranno richiesti per far valere la garanzia.

K- AVVERTENZE

- Mantenere una distanza minima (10 cm) intorno al dispositivo per una sufficiente aerazione.
- Non ostacolare l'aerazione ostruendo le prese d'aria con oggetti come giornali, tovaglie, tende, ecc.
- Non avvicinare l'apparecchio a fiamme libere, come quelle delle candele accese.
- Il normale funzionamento del prodotto può essere disturbato da una forte interferenza elettromagnetica.
- Questa attrezzatura è destinata esclusivamente ad uso privato.
- Il dispositivo non deve essere esposto a gocciolamenti o schizzi d'acqua. È vietato posizionare sul dispositivo oggetti pieni di liquido come dei vasi.
- La presa della rete di alimentazione deve rimanere facilmente accessibile. Viene utilizzata come dispositivo di spegnimento.
- Il monitor e l'adattatore devono essere utilizzati all'interno.
- Eseguire tutti i collegamenti tra gli elementi prima di alimentare il kit.
- Collegare il dispositivo solo con l'adattatore in dotazione.
- Gli elementi elettronici devono essere maneggiati con attenzione.
- Non tappare il microfono della piastra esterna e del monitor.
- Durante l'installazione, gli imballaggi non devono essere lasciati alla portata di bambini o animali, poiché costituiscono una potenziale fonte di pericolo.
- Questo prodotto non è un giocattolo. Non è stato progettato per essere utilizzato dai bambini.

 Prima di ogni eventuale manutenzione, scollegare i dispositivi. Non pulire il prodotto con solventi, sostanze abrasive o corrosive. Per pulire lo schermo del monitor, servirsi di un semplice panno morbido. Non spruzzare niente sul prodotto.

 Verificare la buona manutenzione del prodotto e controllare frequentemente l'impianto per individuare ogni eventuale segno di usura. Non utilizzare il dispositivo se sono necessarie riparazioni o regolazioni. Rivolgersi a personale qualificato.

 Non gettare gli apparecchi fuori uso insieme ai normali rifiuti domestici. Potrebbero contenere sostanze pericolose capaci di nuocere alla salute e all'ambiente. Utilizzare i mezzi per la raccolta differenziata messi a disposizione dal comune o dal proprio distributore.

 Corrente continua  Corrente alternata  Modello di classe II

 Il monitor è destinato esclusivamente all'uso interno



IP 55 : L'unità esterna è protetta dai depositi di polvere nociva e dai getti d'acqua provenienti da tutte le direzioni.

L- DICHIARAZIONE UE DI CONFORMITÀ

Con la presente, SCS Sentinel certifica che il prodotto è conforme alle esigenze essenziali applicabili e in particolare alle esigenze della direttiva 2014/53/UE. La dichiarazione UE di conformità completa può essere consultata sul sito web: www.scs-sentinel.com/downloads.

ÍNDICE

A- Precauciones para el uso	52
B- Descripción	52
C- Cableado / Instalación	53
D- Uso	55
E- Ajustes	57
F- Configuración	59
G- Ajuste	62
H- Características técnicas.....	66
I- Asistencia técnica	67
J- Avisos	67
K- Garantía.....	67
L- Declaración de conformidad.....	67

A- PRECAUCIONES PARA EL USO

Este manual forma parte de su producto. Se facilitan la siguientes instrucciones para su seguridad. Leer detenidamente estas instrucciones antes de utilizar el producto y conservarlas para futuras consultas. Elegir un emplazamiento adecuado. Asegurarse de que ningún elemento dificulte la sujeción de los tacos y tornillos en la pared. Terminar y controlar su instalación antes de enchufar. No enchufar su alimentación mientras su instalación no esté terminada y controlada. La instalación, las conexiones eléctricas y los ajustes deben efectuarse por una persona calificada y especializada. El bloque de alimentación debe instalarse en un lugar seco. Usar el equipo únicamente para el fin para el que ha sido diseñado.

La función de este videoteléfono es identificar a un visitante, no debe utilizarse para vigilancia callejera. La utilización de esta instalación debe ser conforme a la ley francesa n° 78-17 del 6 de enero de 1978 relativa a la informática, a los ficheros y a las libertades. Corresponde al comprador informarse en la CNIL sobre las condiciones y autorizaciones administrativas necesarias para una utilización fuera de un contexto estrictamente personal. SCS Sentinel no podrá ser considerada responsable en caso de utilización de este producto fuera de las leyes y reglamentos en vigor.

Este producto sólo funciona con la aplicación iSCS Sentinel. La aplicación está disponible de forma gratuita en PlayStore y AppStore. Actualizaciones pueden ser necesarias, por ejemplo, para corregir errores, mejorar funciones o la experiencia del usuario. Puede activar o desactivar las actualizaciones automáticas para la aplicación iSCS Sentinel en la configuración de PlayStore o AppStore. La información relativa al motivo de la actualización, su impacto en el rendimiento y la evolución de las funcionalidades del producto o aplicación, así como el espacio de almacenamiento utilizado, se indican, para cada actualización en PlayStore o Apple Store.

De acuerdo con la normativa y la garantía legal, se garantizan la disponibilidad y actualizaciones de la aplicación durante 2 años. **Este manual puede estar sujeto a cambios en función de las actualizaciones de la aplicación. Para asegurarse de que tiene la última versión, le aconsejamos que la descargue de nuestro sitio web www.scs-sentinel.com o de la aplicación iSCS Sentinel : ajustes / manuales.**

B- DESCRIPCIÓN

B1- Contenido / dimensiones

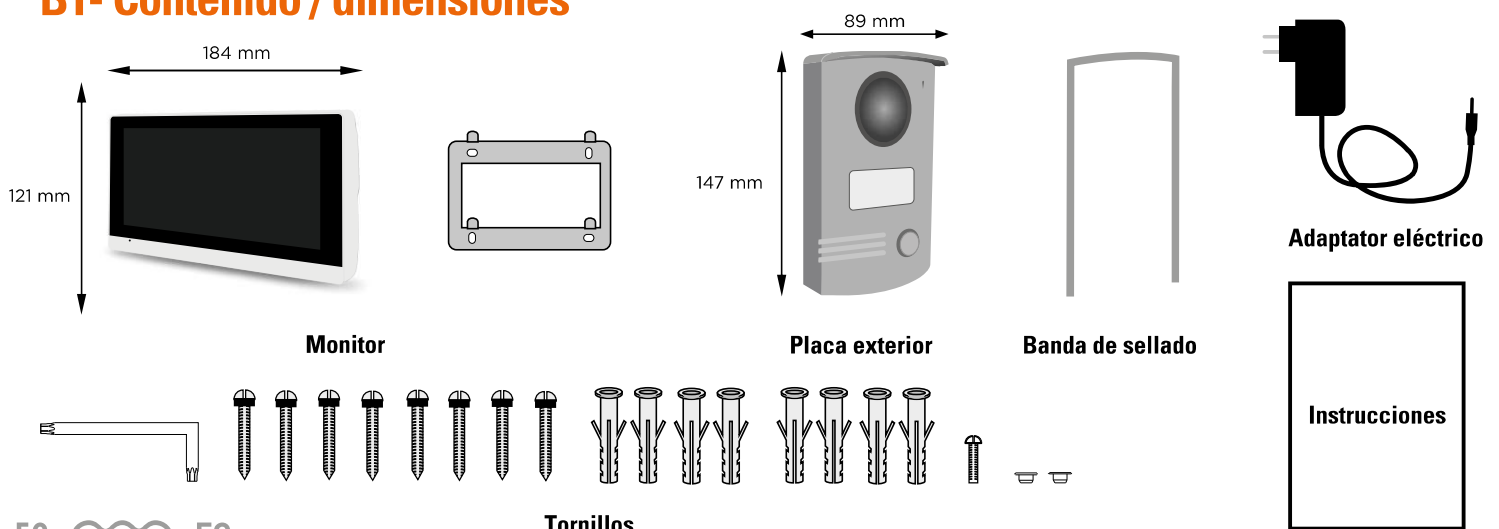

B2- Presentación del producto

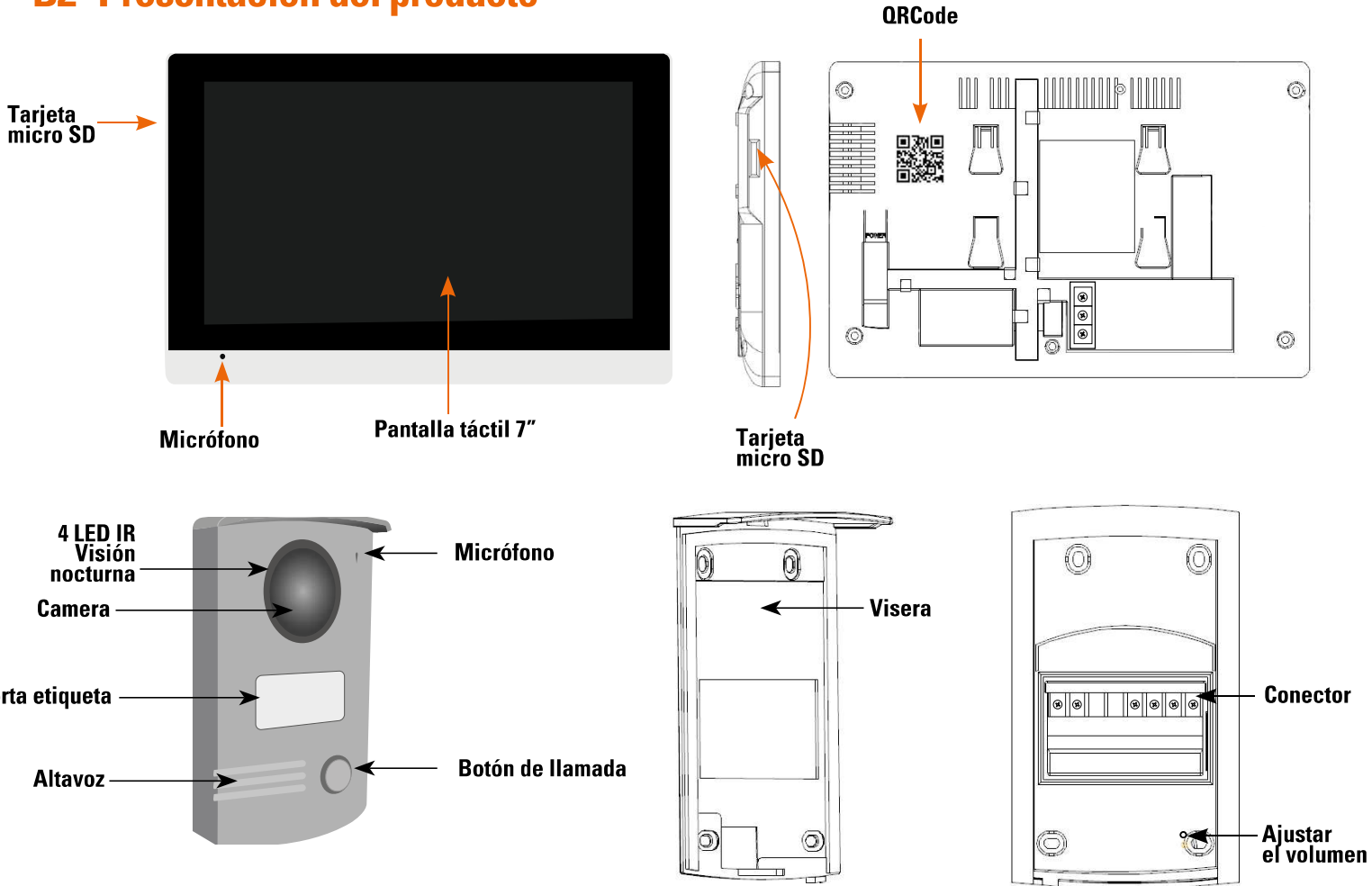

C- CABLEADO / INSTALACIÓN

C1- Impianto

Monitor

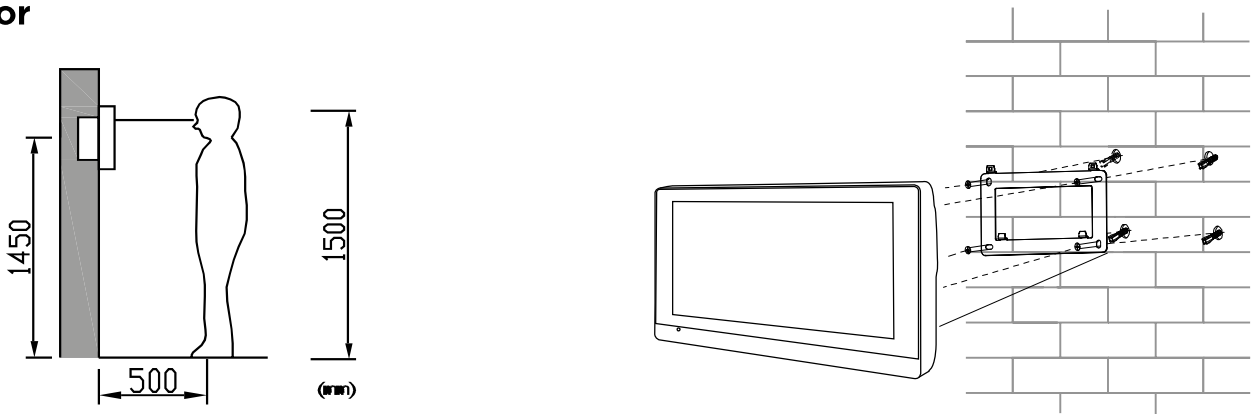

Placa exterior

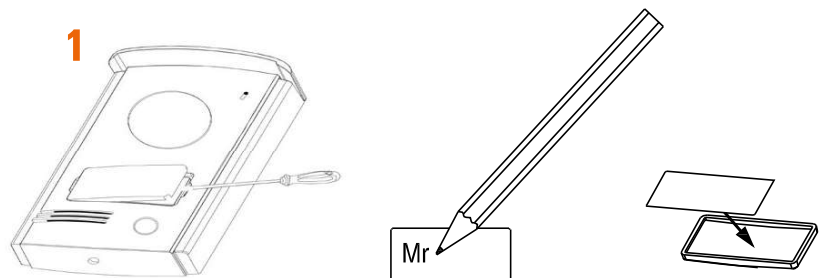
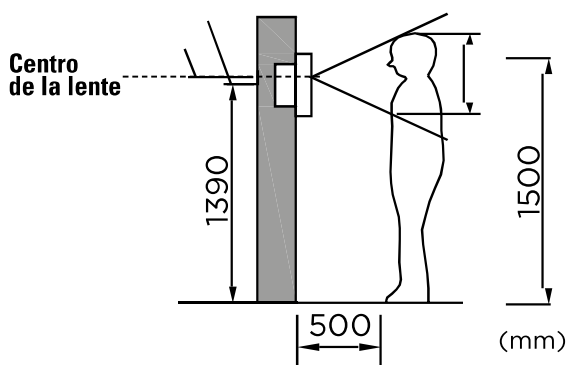

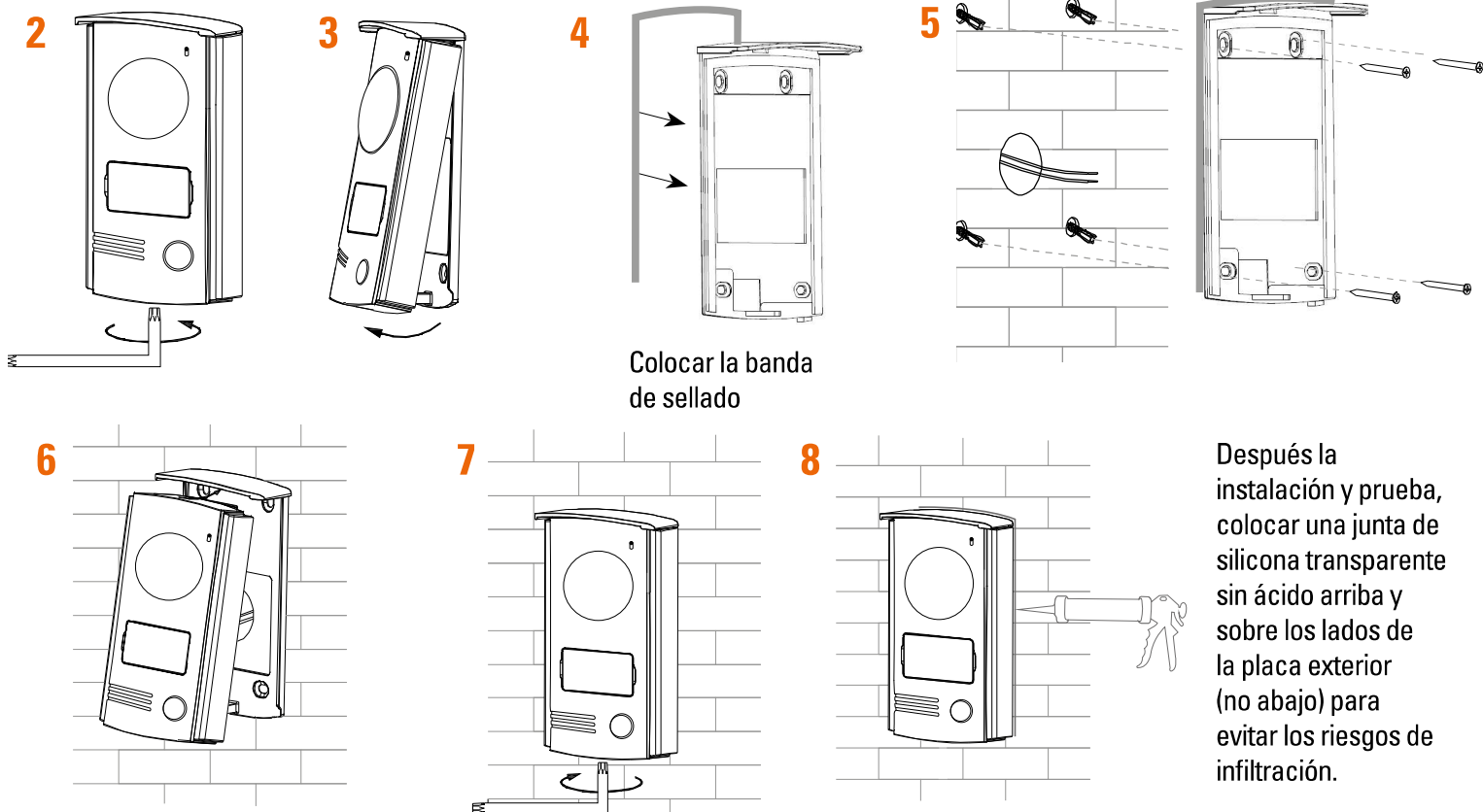

C2- Esquema de cableado

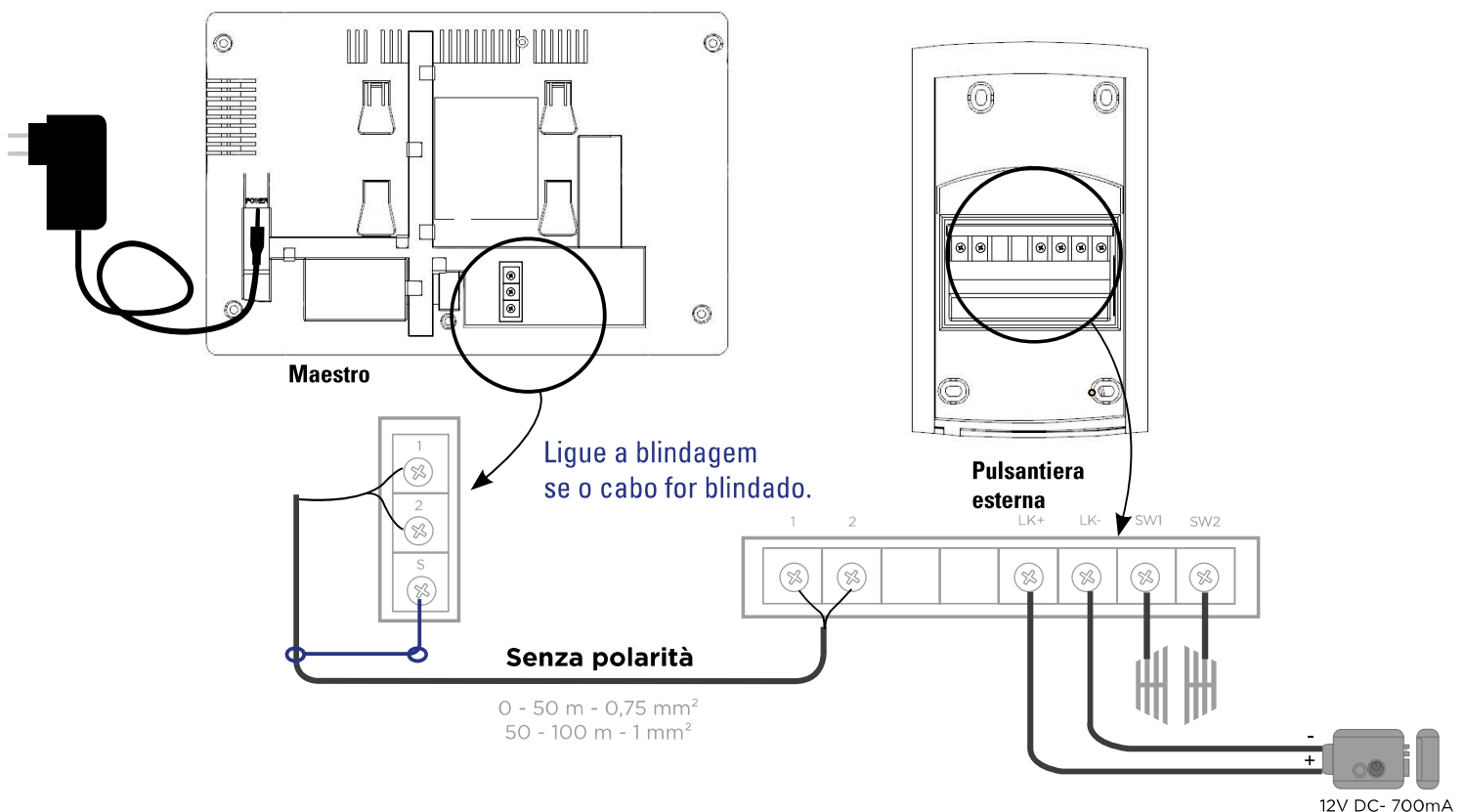

Tiene la posibilidad de conectar directamente el monitor al panel eléctrico vía un transformador 15V DC 0,8A (minimum). Se necesitan conocimientos eléctricos, le aconsejamos que contacte con un profesional.

ATENCIÓN : ¡RESPECTE LA POLARIDAD!
El hilo con las líneas grises debe colocarse en el +. El hilo con las escrituras debe colocarse en el -.

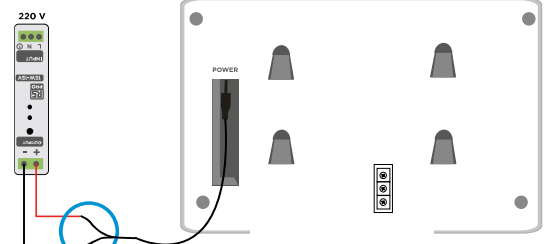

D- USO

D1- Llamada desde la placa exterior



-  Pantalla de ajustes
-  Activar un automatismo de portal
-  Activar una cerradura
-  Capturar una vídeo
-  Capturar una foto
-  Contestar / Colgar
-  Volver a la pantalla principal (la llamada perdida no será reportada)

D2- Pantalla principal

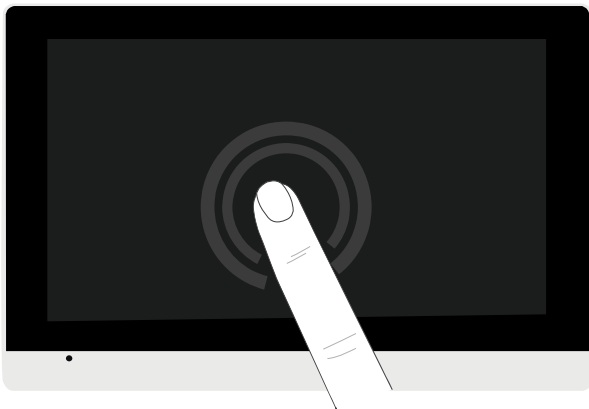

Para salir del modo de espera, tocar la pantalla

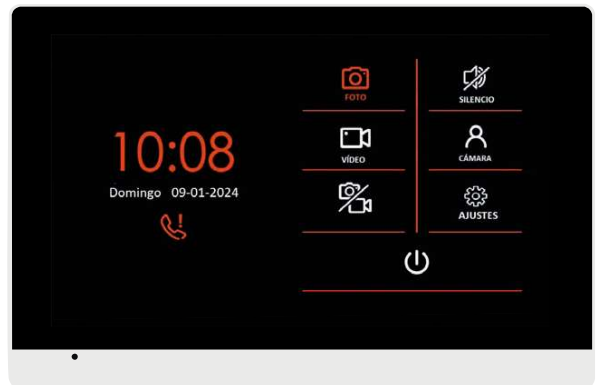

Visualización de fotos



Visualización de vídeo



Seleccionar si el aparato toma una foto y(o) un vídeo en cada llamada



Modo de espera (La pantalla se apaga automáticamente después de 1 minuto)



Modo silencioso (este icono aparecerá en la parte superior de la pantalla si se elige el modo silencioso)



Vista de cámara



Ajustes

D3- Visualización de fotos y videos



Fotos

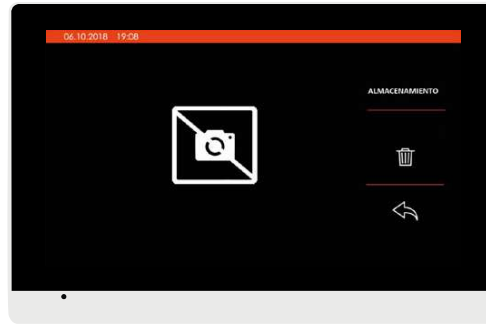

- ALMACENAMIENTO visualizar las fotos del monitor
- Suprimir la foto
- Volver a la pantalla principal

D4- Modo silencioso



Modo silencioso

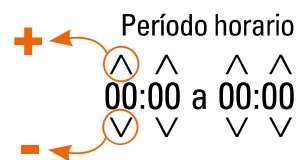
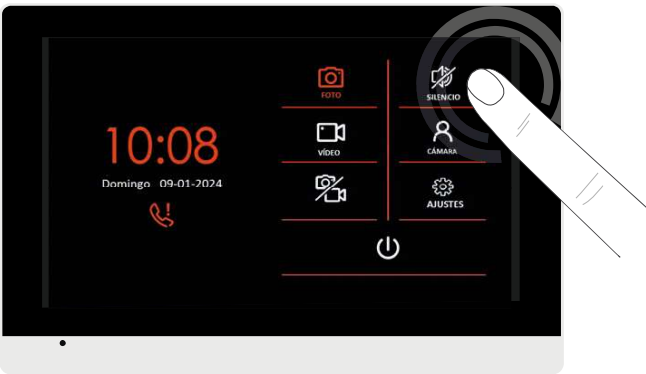

D5- Visualización cámara



Cámara

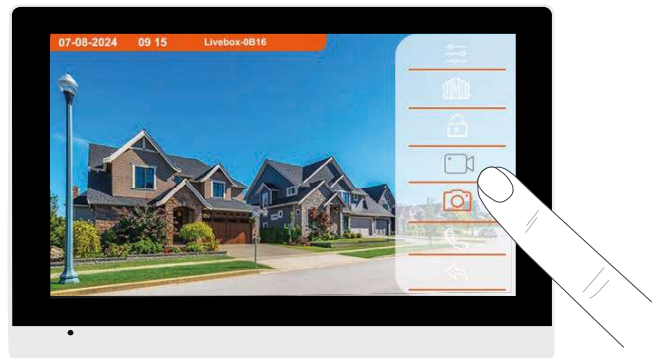
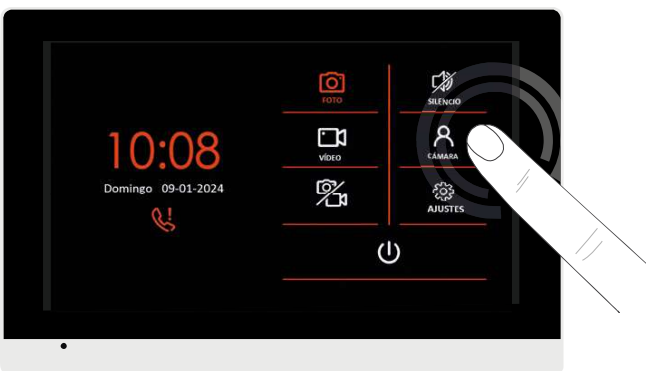

Puede acceder a la vista de la estación de puerta desde casa haciendo clic en el icono de la cámara

E- AJUSTES

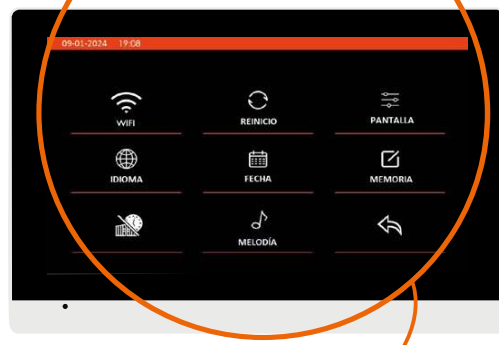

Wi-Fi	Reset	Pantalla de ajustes
Selección de idiomas	Ajuste de la fecha y hora	Copia de seguridad de la memoria interna en la tarjeta micro SD / suprimir todas las fotos / videos / Formatear la tarjeta micro SD
Tiempo de cierre del contacto seco para la puerta	Ajuste de la melodía	Volver a la pantalla principal

Wi-Fi

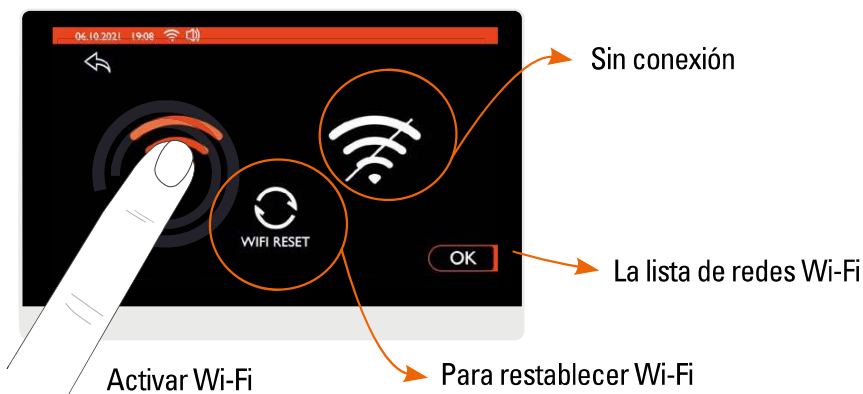



Melodía



Vuelta de llamada activada



Vuelta de llamada desactivada

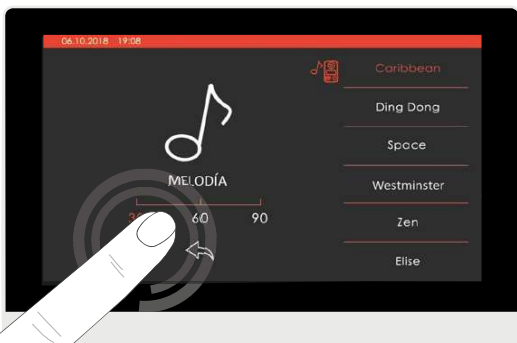

Seleccionar el período timbre
30, 60 ou 90 segundos

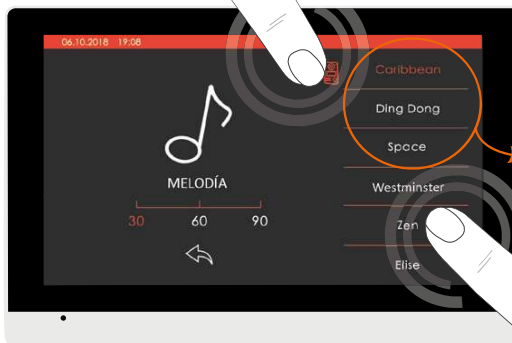

Selección
melodía

3 melodías premium
con vuelta de llamada
posible con la placa
exterior



Reset

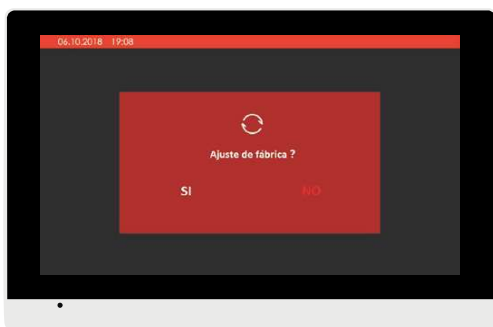

Esta función permite restablecer
todos los datos y ajustes iniciales
del aparato.



Pantalla de ajustes



Luminosidad



Color



Contrasto



Volumen de la melodía



Volumen de la voz



Volver a la pantalla
principal



Selección de idiomas

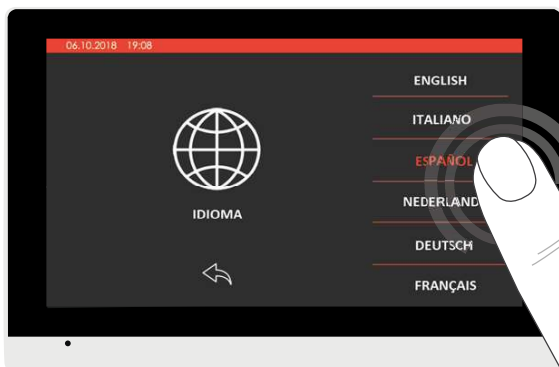



Ajuste de la fecha

Ajuste automático de la fecha y la hora (Si la conexión a Internet)

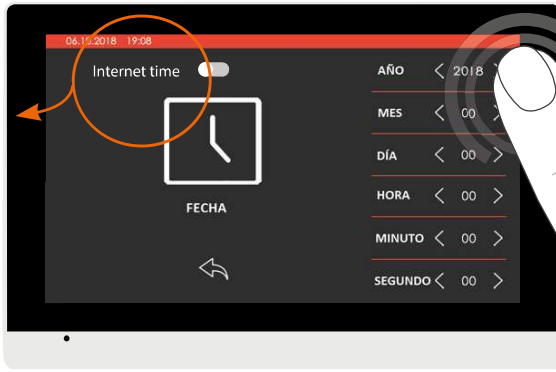

Copia de seguridad en tarjeta SD

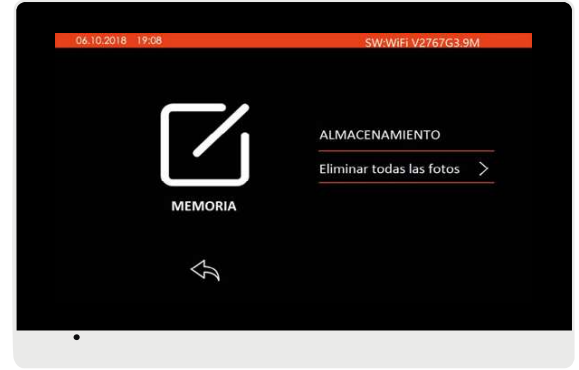

F- CONFIGURACIÓN

Instalación de la aplicación



iSCS Sentinel

Descargar la aplicación en la App Store o Play Store del smartphone. Buscar «iSCS Sentinel» y hacer clic en Instalar.



1. Al final de la descarga, abrir la aplicación y hacer clic en crear mi cuenta



2. Introducir la dirección de correo electrónico y la contraseña en las casillas correspondientes.

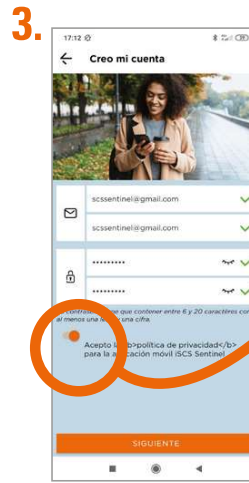

3. Pulsar «siguiente».



Aceptar la política de privacidad antes de hacer clic en siguiente



4. Introducir el código de validación que ha recibido por correo electrónico. Luego, validar la cuenta.

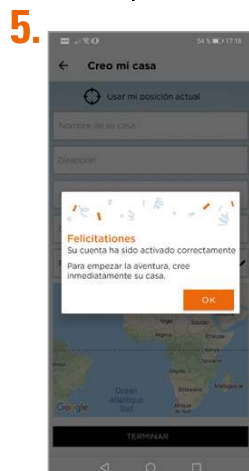

6. Pulsar AUTORIZAR.

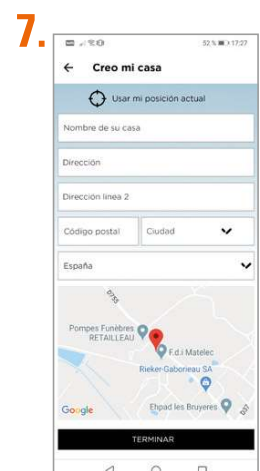

7. Introducir toda la información necesaria para crear la casa. Luego, hacer clic en terminar.

Añadir la cámara

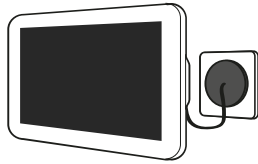

Enchufar la fuente de alimentación del monitor y colocarlo cerca del router Wi-Fi. El teléfono debe estar conectado a la misma red Wi-Fi que el monitor y la localización debe estar activada.



Algunos materiales pueden reducir el alcance de la red Wi-Fi.

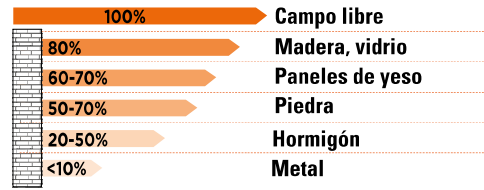

Pulsar + y luego «NUEVO DISPOSITIVO» para añadir el producto.

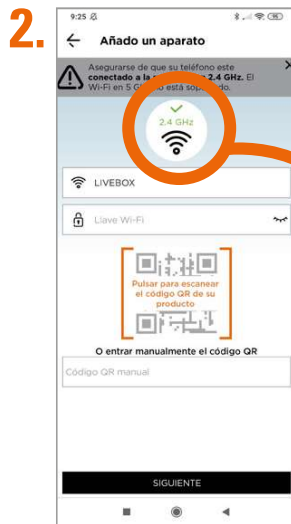

La red debe estar en 2,4 GHz para funcionar.



Introducir la clave Wi-Fi, escanear el código QR de la parte trasera del monitor o introducir el código manualmente.



En el monitor, ir a Ajustes y pulsar el icono «WiFi». Esperar a que el botón OK aparezca resaltado. Seleccionar la red WiFi e introducir la contraseña.

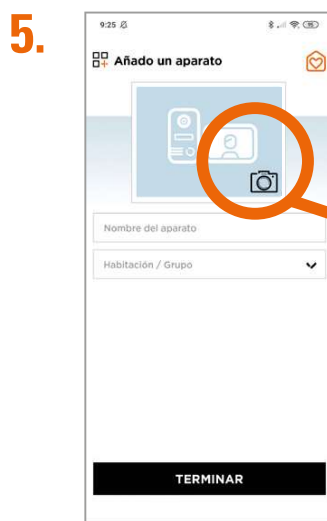
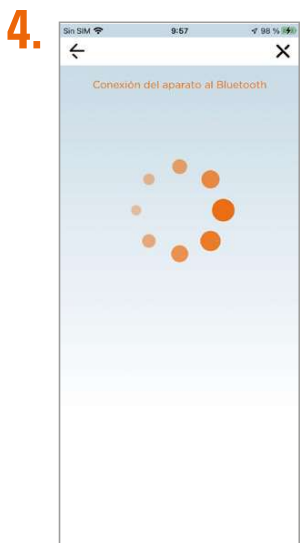

Introducir un nombre para el videoportero y la sala donde se encuentra el producto.



Añadir una foto de perfil desde la cámara, la galería o seleccionar una imagen predeterminada (foto de producto o última captura de movimiento).



Si el dispositivo no se conecta a la red Wi-Fi, aparecerá una página de error.

Resolución en caso de fallo

1.



2.



Hacer clic en «Repetir la operación»: volverá al paso 2



Si «Repetir la operación» no funciona, pulsar «Otro método»

3.

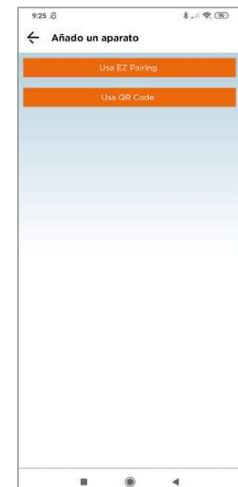

Comprobar estos 5 puntos.

Pulsar «QR Code»

4.



Comprobar la información y hacer clic en siguiente.

5.



Hacer clic en «mostrar código QR».

6.



Escanear el código QR que aparece con la placa y, tras la señal sonora, pulsar «sí».



Se completa la carga y se validan los 3 pasos. A continuación, volver a los pasos 5 y 6 para cambiar la foto de perfil.

G- AJUSTE

Ajustes de la aplicación

1.  Pulsar  para acceder a los ajustes de la aplicación.

2.  **Ver mi perfil:**
Modificación de las informaciones personales

Para añadir una casa

1. 

Hacer clic en 

2.  Crear una nueva casa.

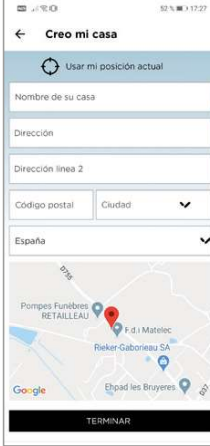

3. 

Rellenar los campos y pulsar **TERMINAR.**

Para suprimir una casa

1. 

Pulsar 

2.  Pulsar  para eliminar una casa.

3. 

Para modificar una casa

- 



Pulsar 
- 

Modificar la dirección.
- 

REGISTRAR

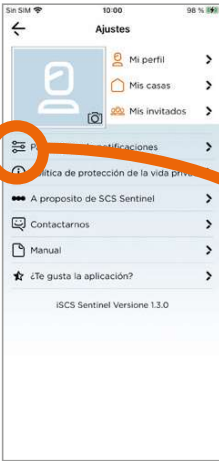
Configuración de las notificaciones

- 

Pulsar  para acceder a la configuración de las notificaciones.
- 

Pulsar «Activar notificaciones» para activar todas las notificaciones. De lo contrario, pulsar sólo las notificaciones deseadas.

Uso de la aplicación

- 

Pulsar para hablar.
- 

Captura de fotografías en el teléfono.

Activar la pantalla completa (girar el teléfono).

Captura de vídeo en el teléfono.
- 

Abrir o cerrar el portal

Liberar la cerradura

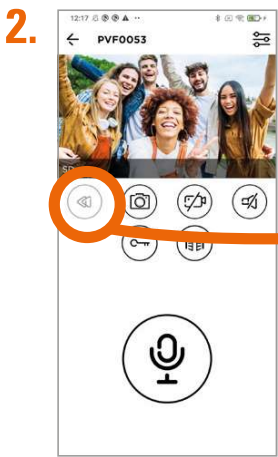

Ver lo que pasó

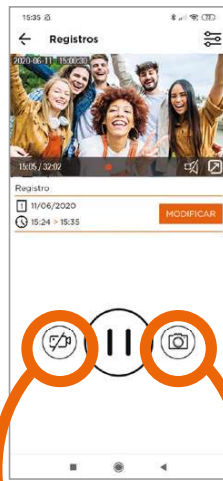

Grabar un vídeo

Grabar una foto



Pulsar  para modificar la configuración del producto.



Por defecto, el producto aparecerá en la lista de favoritos al abrir la aplicación.

Pulsar  para agregar/suprimir el producto de los favoritos.



Pulsar «Ajuste de función básica»

Configuración de la tarjeta SD (solo si tiene una en su monitor)



Pulsar «Tarjeta SD» para acceder a los ajustes.



Pulsar «Registro sobre la tarjeta SD» para guardar automáticamente las fotografías y los vídeos en la tarjeta micro SD del monitor.

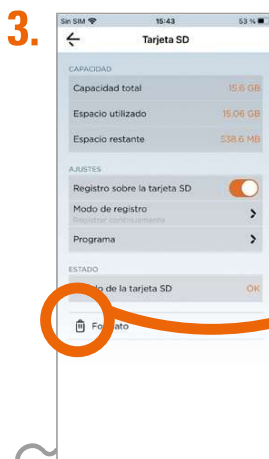

Pulsar «Formato» para reiniciar su tarjeta micro SD.

Escenario

Un escenario es una acción que sigue a un evento o eventos desencadenantes.

1

Seleccione/los eventos desencadenantes. Si tiene varios disparadores, puede elegir entre combinarlos (Y) o separarlos para realizar la acción (O).

2

Defina el/las acciones a realizar.

3

Registrar su escenario.

A continuación, la aplicación ejecutará la/las acciones(s) del escenario una vez que haya detectado un disparador.

SIGUIENTE



Para seleccionar uno o varios eventos de activación (dispositivo, fecha/hora o ubicación), pulsar +.

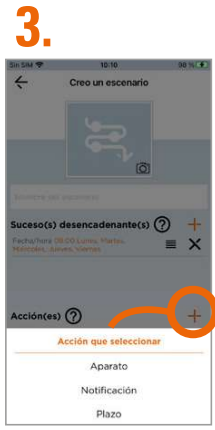

Para seleccionar una o varias acciones (dispositivo, notificación o retardo) pulsar +.



Por defecto, el escenario aparecerá en la lista de favoritos.



El escenario se activa

Para añadir invitados

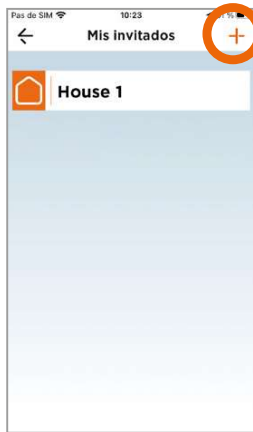

Activar las «acciones» del escenario sin esperar a los «eventos desencadenantes».

⚠ A través de la aplicación iSCS Sentinel, el invitado puede activar/desactivar los dispositivos pero no puede configurarlos.

Reset

Para eliminar el dispositivo por completo, hay que eliminarlo en la aplicación.



H- CARACTERÍSTICAS TÉCNICAS

Monitor	Alimentación	15V DC 0,8A
	Pantalla	Pantalla táctil 7" TFT LCD
	Resolución de pantalla LCD	1024 x 600 px
	Memoria interna (fotos)	14 Mo. Cuando la memoria está llena, la nueva foto sobrescribirá automáticamente la foto más antigua.
	Copia de seguridad en tarjeta SD externa (foto y videos)	4 Go - 32 Go clase 4 - 10 (no suministrada) Es necesario formatear la tarjeta micro SD antes de utilizar
	Frecuencia de funcionamiento	2412 MHz - 2472 MHz
	Potencia máxima de transmisión	< 100mW
	Wi-Fi	802 11b/g/n

Placa exterior

Material	Aleación de aluminio
Ángulo de visión	100°
Visión nocturna	LED IR
Temperatura de servicio	-10°C /+ 50°C
Índice de protección	IP55

Adaptador

Referencia del modelo	SH-7000-15-1A
Tensión de entrada	110-240V AC
Frecuencia de CA de entrada	50/60Hz
Tensión de salida	15V DC
Corriente de salida	0.8A
Potencia de salida	12W
Rendimiento medio en activo	84.03%
Rendimiento bajo carga (10%)	78.41%
Consumo eléctrico sin carga	0.084W

I- ASISTENCIA TÉCNICA

I1- Consejos de los expertos

Los técnicos del servicio posventa están disponibles en el siguiente número:



937376105

Si el producto funciona mal durante la instalación o pocos días después, póngase en contacto con el servicio de atención al cliente permaneciendo cerca del producto para que nuestros técnicos puedan diagnosticar el problema inmediatamente.

I2 - Chat en línea



Una pregunta ?

Para una respuesta personalizada, se puede utilizar nuestro chat en línea en nuestro sitio web www.scs-sentinel.com

J- GARANTÍA



SCS Sentinel concede a este producto una garantía superior a la duración legal, como referencia de calidad y fiabilidad.

Conservar el recibo de compra durante todo este período de garantía.

Conservar el código de barra así como que su justificante de compra, serán necesarios para hacer uso de la garantía.

K- AVISOS

- Mantener una distancia mínima de 10 cm alrededor del aparato para asegurar una ventilación suficiente.
- La ventilación no se debe obstaculizar cubriendo las aperturas de ventilación con elementos como por ejemplo periódicos, manteles, cortinas, etc.
- No colocar el aparato cerca de llamas vivas, como velas encendidas.
- Importantes interferencias electromagnéticas pueden perturbar el funcionamiento normal del producto.
- El producto sólo está destinado al uso privado.
- El aparato no debe estar expuesto a goteo o derrames de agua. Ningún objeto que contenga líquido, como por ejemplo vasijas, deben colocarse cerca del aparato.
- La toma de corriente debe mantenerse fácilmente accesible. Se usa como mecanismo de desconexión.
- El monitor y el adaptador sólo se pueden usar en interiores.
- Efectuar todas la conexiones entre los elementos antes de enchufar el kit.
- Exclusivamente conectar el equipo con el adaptador incluido.
- Manejar los elementos con cuidado. Los componentes electrónicos son frágiles.
- No obstaculizar el micrófono de la placa exterior o del monitor.
- Durante la instalación del producto, dejar el producto y el embalaje fuera del alcance de los niños o de los animales. Constituyen una fuente potencial de peligro.
- Este producto no es un juguete. No fue diseñado para ser utilizado por niños solos.

 Desconectar el cable de alimentación antes de realizar la limpieza o el mantenimiento. No se debe limpiar el producto con sustancias abrasivas o corrosivas. Utilizar un simple paño suave. No se debe vaporizar ningún producto sobre el aparato.

 Asegurarse de efectuar un correcto mantenimiento del producto y verificar a menudo la instalación para detectar algún posible defecto. No se debe utilizar el aparato si necesita una reparación o un ajuste. Llamar a un personal calificado.



No se deben tirar los aparatos inservibles con los residuos domésticos, ya que las sustancias peligrosas que puedan contener pueden perjudicar la salud y al medio ambiente. Pídale a su distribuidor que los recupere o utilizar los medios de recogida selectiva puestos a disposición por el ayuntamiento.

— Corriente continua ~ Corriente alterna  Modelo de clase II  El monitor es sólo para uso en interiores

IP 55 : La unidad exterior está protegida contra depósitos de polvo nocivos y chorros de agua desde cualquier dirección.



L- DECLARACIÓN DE CONFORMIDAD

Por la presente, SCS Sentinel declara que este producto cumple con los requisitos esenciales y otras disposiciones relevantes de la directiva 2014/53/UE. La declaración de conformidad completa se puede consultar en el sitio web : www.scs-sentinel.com/downloads.