

ADDITIONAL INFORMATION

- DE ZUSÄTZLICHE INFORMATIONEN
- FR INFORMATIONS COMPLÉMENTAIRES
- NL BIJKOMENDE INFORMATIE
- IT ULTERIORI INFORMAZIONI
- DK YDERLIGERE INFORMATION
- FI LISÄTIEDOT
- NO TILLEGGSINFORMASJON
- SE YTTERLIGARE INFORMATION
- ES MÁS INFORMACIÓN
- CZ DALŠÍ INFORMACE

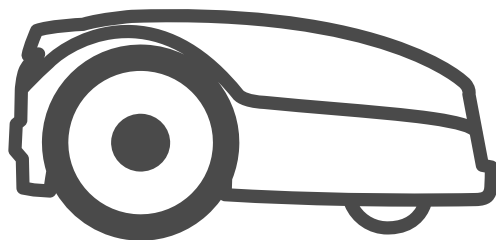

Maintenance and Cleaning

EN



Safety first

1. Switch off the robot
2. Remove the disabling device before doing any maintenance

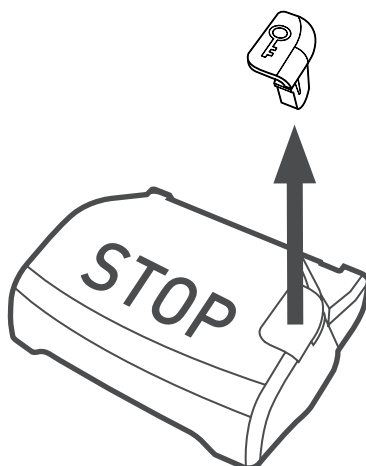
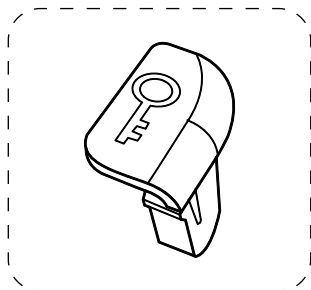
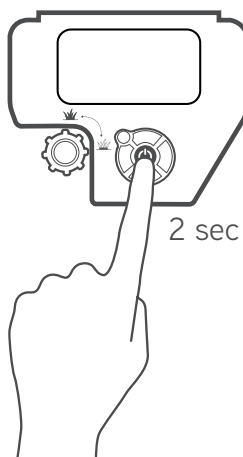

Blade Replacement

Periodically inspect the blades and replace them if damaged. It is recommended to replace the blades per the table below. Always replace all 4 blades, including the screws



< 500 m ²	Every 8 - 10 weeks
500 m ² - 1000 m ²	Every 6 - 8 weeks
> 1000 m ²	Every 4 - 6 weeks

Watch the video

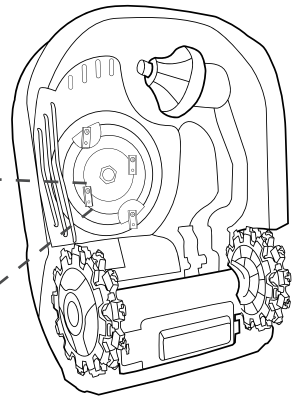
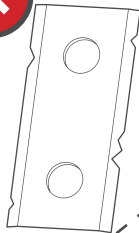
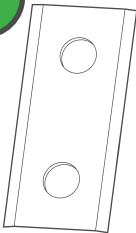

Cleaning

The RK wheels and deck are self-cleaning. Accumulated grass, soil and debris will disperse when dry conditions return.

Every 1-2 weeks, clean the robot underneath.

Remove debris
from the wheels

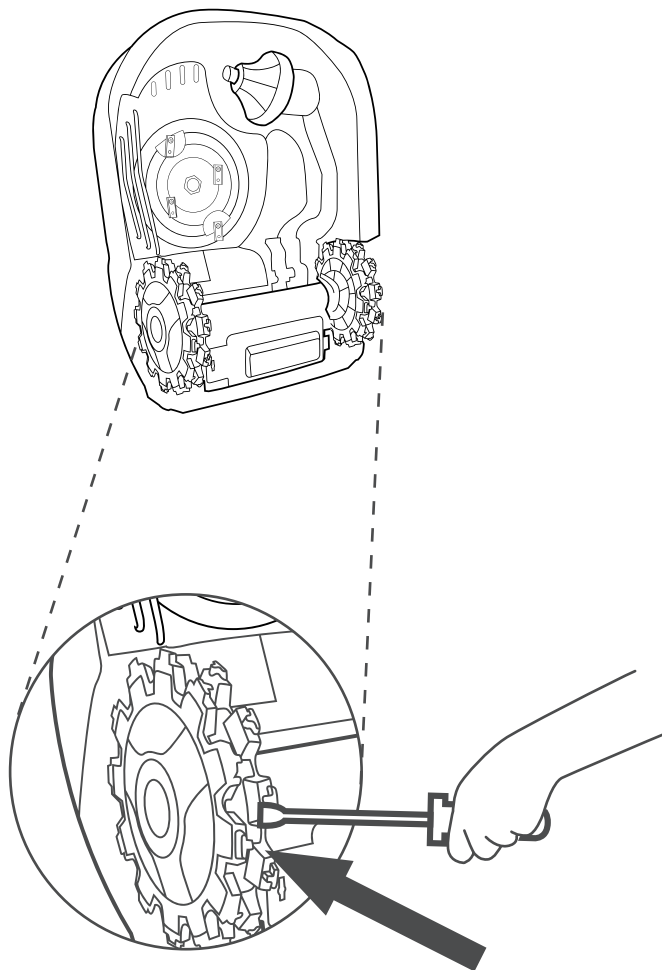

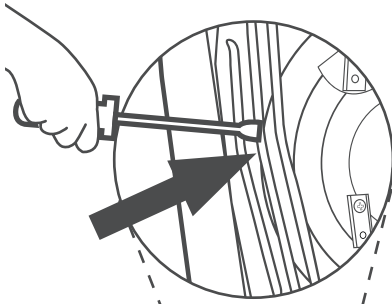

Remove debris between the guard wires

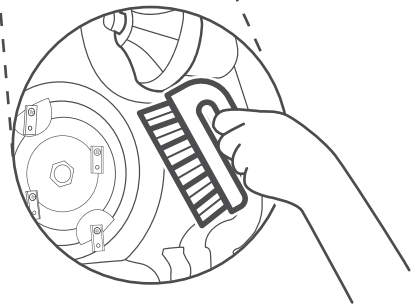
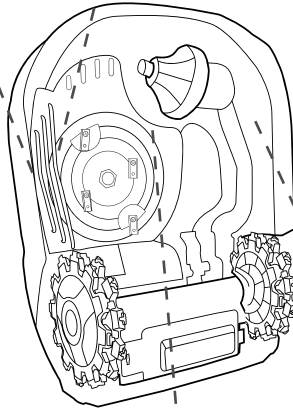

Use a soft brush to remove debris from the mowing deck

Install the wheel cleaners

During longer periods of increased wet conditions, mud and mulch can accumulate on wheels. It is recommended to attach the wheel cleaners accessories to assist in removing debris in these conditions.

Watch the video

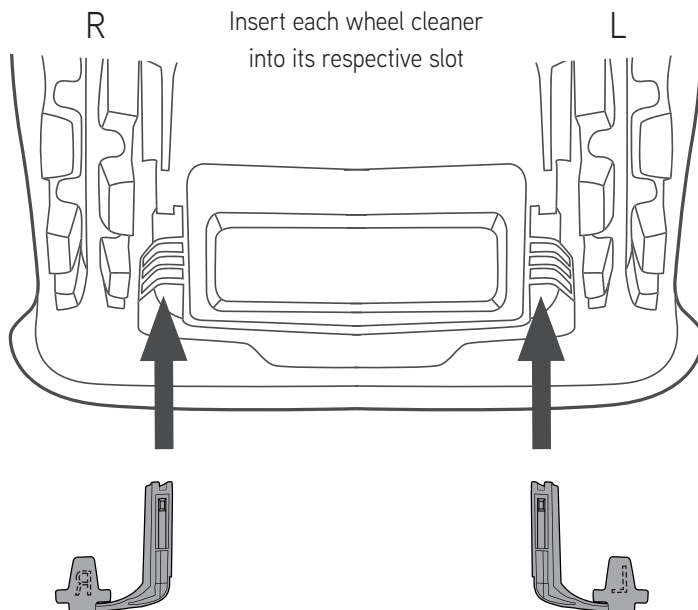
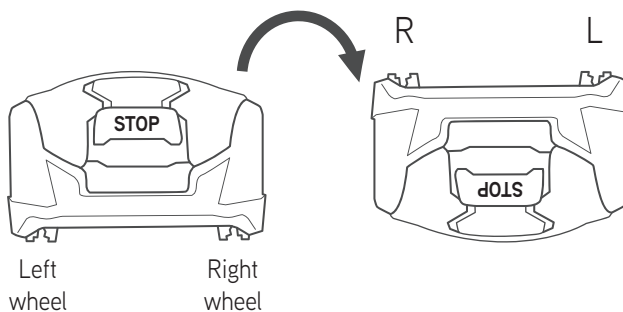

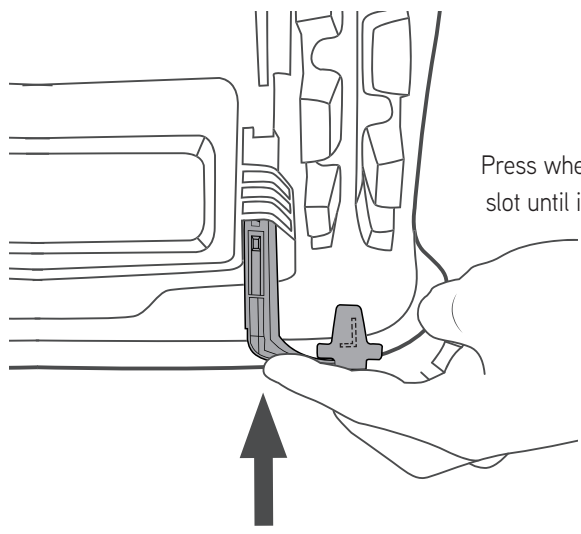

Press wheel cleaner firmly into slot until it is securely in place

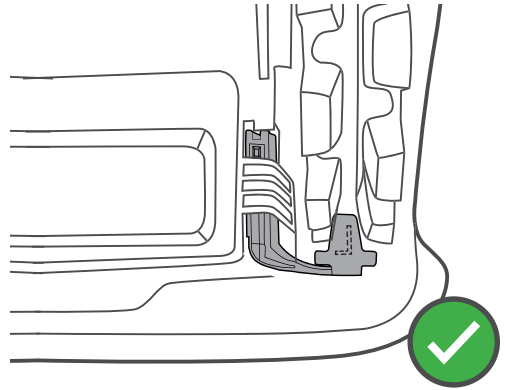

Technical Spec	RK2000	RK1000
Model number	22AKHAFB619	22AKFAFB619
Recommended lawn size [m ²]	Up to 2000 m ²	Up to 1000 m ²
Cutting width [cm]	21	21
Cutting height [mm]	20-100	20-100
Sub-zones / starting points	4	4
Separated zones	2	2
Wire [m]	300	225
Number of pegs	400	300
Mowing motors	DC Brushless	DC Brushless
Drive motors	DC Brushless	DC Brushless
Max. incline mowing area	45% (24°)	45% (24°)
Max. incline wire on slope	20%	20%
Sound pressure level Lpa dB(A) (K=3)	50	50
Measured sound power level Lwa, dB(A)	61	61
Guaranteed sound power level Lwa, dB(A)	64	64
Mowing time [min]	100-120	50-60
Charging time [min]	60-120	60-120
Battery type	Li-Ion	Li-Ion
Battery capacity spec [Ah]	4.9	2.8
Power consumption [kWh/month]	5.1	2.8
Anti-theft	✓	✓
Bluetooth (BLE)	✓	✓
GSM module	✗	✗
Near Wire Following (MBLE/IR)	✓	✓
Max altitude	3,000m	3,000m
Warranty	3 years	3 years

Technical Spec	RK2000 Pro	RK1000 Pro
Model number	22AKHFA619	22AKFAFA619
Recommended lawn size [m ²]	Up to 2000 m ²	Up to 1000 m ²
Cutting width [cm]	21	21
Cutting height [mm]	20-100	20-100
Sub-zones / starting points	4	4
Separated zones	2	2
Wire [m]	×	×
Number of pegs	×	×
Mowing motors	DC Brushless	DC Brushless
Drive motors	DC Brushless	DC Brushless
Max. incline mowing area	45% (24°)	45% (24°)
Max. incline wire on slope	20% (11°)	20% (11°)
Sound pressure level Lpa dB(A) (K=3)	50	50
Measured sound power level Lwa, dB(A)	61	61
Guaranteed sound power level Lwa, dB(A)	64	64
Mowing time [min]	100-120	50-60
Charging time [min]	60-120	60-120
Battery type	18,15V Li-Ion	18,15V Li-Ion
Battery capacity spec [Ah]	4.9	2.8
Power consumption [kWh/month]	5.1	2.8
Anti-theft	✓	✓
Bluetooth (BLE)	✓	✓
GSM module	✓	✓
Near Wire Following (MBLE/IR)	✓	✓
Max altitude	3,000m	3,000m
Warranty	3 years	3 years

EU Declaration of Conformity

EN

The products covered by this Declaration

18 Volt Battery operated Robotic Lawn Mower models: Robomow RK1000 and RK2000 with the Base Station, may be followed by „Pro“, with serial number dating year 2020 week 46 and onwards (The year and week are indicated on the product label in the digits three to six: RK2046...)

MTD Products AG declares that the products identified above conform to the following EU Directives and their harmonized standards:

Directive 2006/42/EC - EN 60335-1:2012+AC:2014+A11:2014+A13:2017+A1:2019+A2:2019+A14:2019,

EN 50636-2-107:2015+A1:2018+A2:2020.

Directive 2014/53/EU - EN 303 447 V1.2.0 (draft), EN 300 328 V2.2.2,

EN 301 511 V12.5.1, EN 62311:2008, and

Mentioned in 2014/30/EU - EN 55014-1:2017,

EN 55014-2:2015,

EN 61000-3-2:2014,

EN 61000-3-3:2013,

EN 301489-1 V2.2.3,

EN 301489-3 V2.1.1,

EN 301489-17 V3.2.4,

EN 301489-52 V1.1.0.

Directive 2000/14/EC.

Directive 2011/65/EU.

Directive 2012/19/EU.

The products have been developed in conformance with the following standards:

IEC 60335-1:2016 (Edition 5.2), IEC 60335-2-107:2017 (Edition 2.0)

Notified Body assessment by TUV Rheinland LGA was made for Article 3.2 of the Directive 2014/53/EU, EU-type certificate number RT 60152438 0001.

Authorised representative for documents:

Dipl. Ing. (FH) Bernd Staudt.

Jason L. Zielke

VP Product Development - EMEA

Saarbrücken, 8 Nov 2020

signature

RED 2014/53/EU info

These products utilize radio transmitters.
Specifications are in the table below.

Tx type	Frequency	Max power
BLE	2402 – 2480 MHz	< 6 mW
GSM EGSM900	880.2 – 914.8 MHz	< 2.29 W
GSM DSC1800	1710.2 – 1784.8 MHz	< 1.38 W
SRD	3 – 8kHz	< 73.2 dBuA/m @ 10m

Replacement parts

Part Number	Part Description
725-14826	Battery for RK1000
725-14827	Battery for RK2000
122-100-619	Blade Kit
742-05538	Single blade
725-12966	Power supply for RK1000 EU
725-12565	Power supply for RK2000 EU

Wartung und Reinigung



Sicherheit zuerst

DE

1. Schalten Sie den Roboter aus.
2. Entfernen Sie den Unterbrecher aus, bevor Sie eine Wartung vornehmen.

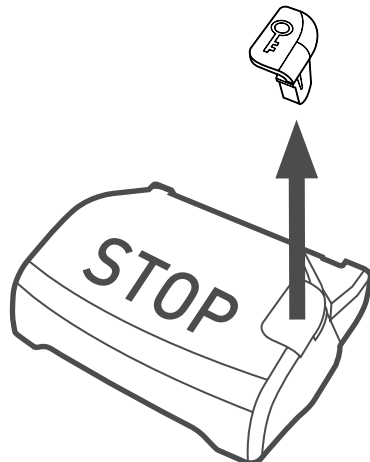
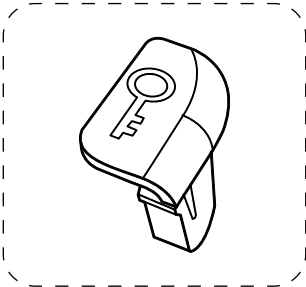
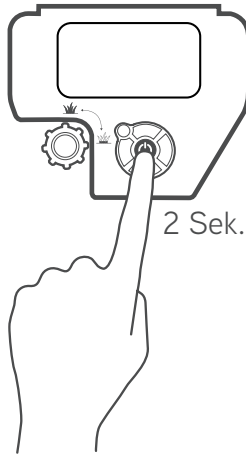

Austausch der Messer

Untersuchen Sie regelmäßig die Messer, und tauschen Sie sie aus, sofern sie beschädigt sind.

Es ist empfehlenswert, die Messer gemäß der nachfolgenden Tabelle auszutauschen.

Tauschen Sie immer alle 4 Messer aus, einschließlich der Schrauben.



< 500 m ²	Alle 8 bis 10 Wochen
500 m ² bis 1000 m ²	Alle 6 bis 8 Wochen
> 1.000 m ²	Alle 4 bis 6 Wochen

Video ansehen

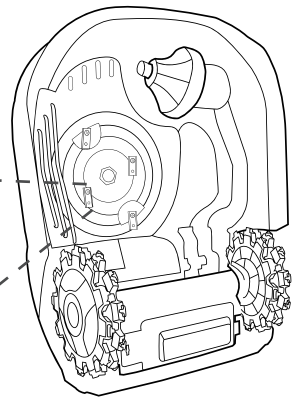
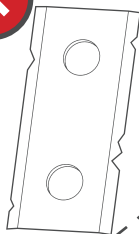
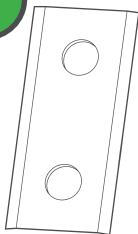

Reinigung

DE Die RK-Räder und das Deck sind selbstreinigend. Angesammeltes Gras, Erde und Schmutz lösen sich bei trockenen Wetterbedingungen auf. Reinigen Sie den Roboter alle 1 bis 2 Wochen von unten.

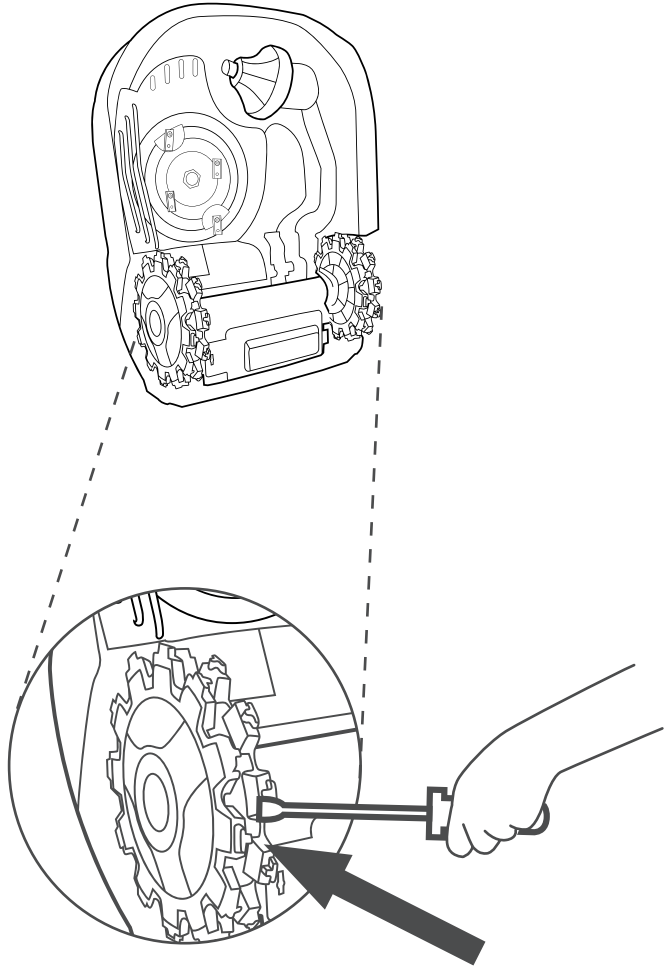

Entfernen Sie
Schmutz von den
Rädern.

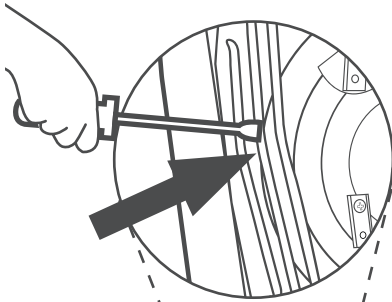

Entfernen Sie Schmutz
zwischen den
Schutzdrähten.

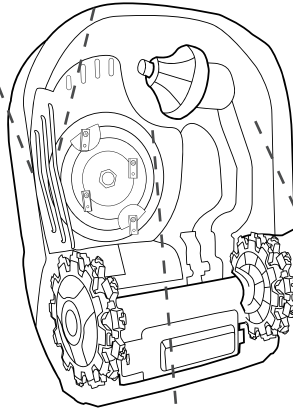

Verwenden Sie eine weiche
Bürste, um Schmutz vom
Mähdeck zu entfernen.

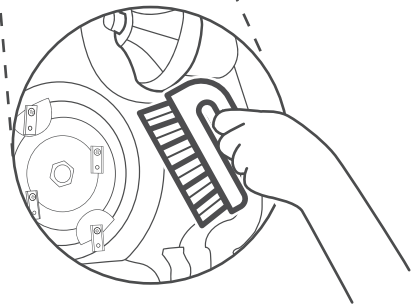

Installation der Radreiniger

DE Während länger anhaltenden sehr feuchten Bedingungen kann sich Schlamm und Mulch an den Rädern anhäufen. Es wird empfohlen, das Radreiniger-Zubehör anzubringen, um Schmutz bei diesen Bedingungen leichter zu entfernen.

Video ansehen

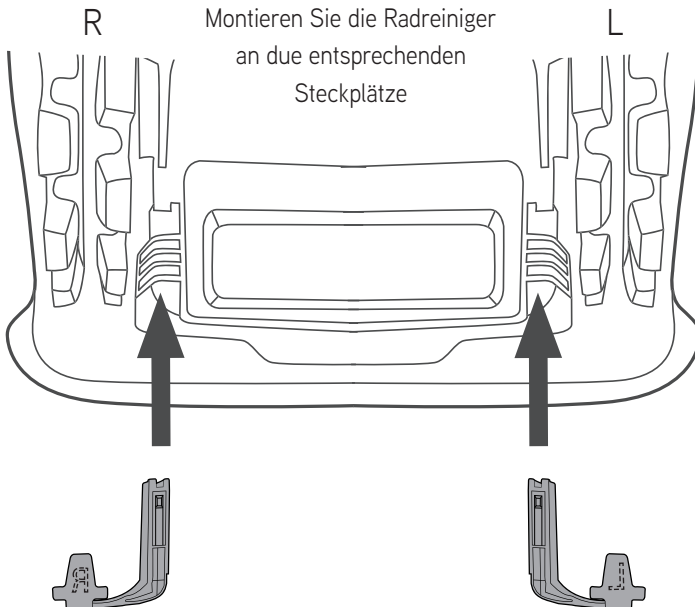
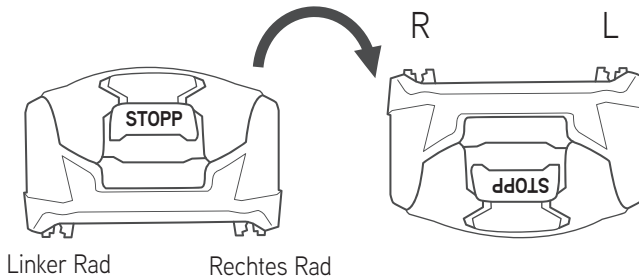

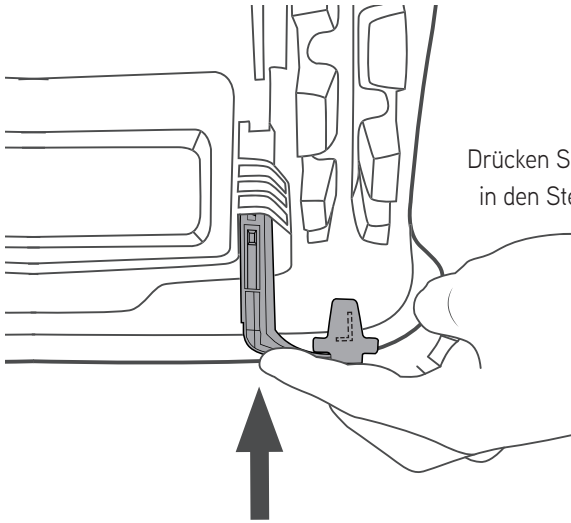

Drücken Sie den Radreiniger fest
in den Steckplatz, bis er sicher
einrastet

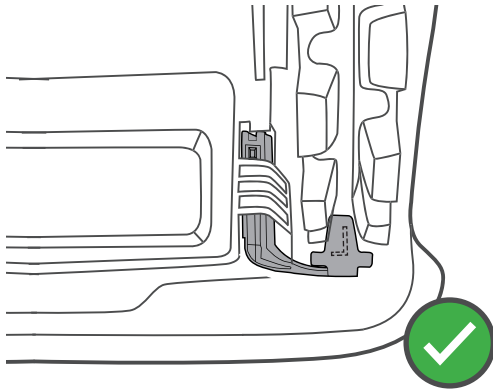

Technische Spezifikationen	RK2000	RK1000
Modellnummer	22AKHAFB619	22AKFAFB619
Empfohlene Rasenfläche [m ²]	Bis zu 2.000 m ²	Bis zu 1.000 m ²
Schnittbreite [cm]	21	21
Schnitthöhe [mm]	20-100	20-100
Nebenzonen/Startpunkte	4	4
Separate Zonen	2	2
Draht [m]	300	225
Anzahl Rasennägel	400	300
Mähroboter-Motoren	DC Bürstenloser Motor	DC Bürstenloser Motor
Antriebsmotoren	DC Bürstenloser Motor	DC Bürstenloser Motor
Max. Neigung im Mähbereich	45% (24°)	45% (24°)
Max. Neigung Draht am Gefälle	20%	20%
Schalldruckpegel Lpa dB(A) (K=3)	50	50
Gemessener Schalleistungspegel Lwa, dB(A)	61	61
Garantierter Schalleistungspegel Lwa, dB(A)	64	64
Mähdauer [Min.]	100-120	50-60
Ladezeit [Min.]	60-120	60-120
Batterietyp	Li-Ion	Li-Ion
Spez. Akkukapazität [Ah]	4,9	2,8
Stromverbrauch [kWh/Monat]	5,1	2,8
Diebstahlsicherung	✓	✓
Bluetooth (BLE)	✓	✓
GSM-Modul	✗	✗
Nahe Draht folg. (MBLE/IR)	✓	✓
Max. Höhe	3.000 m	3.000 m
Garantie	3 Jahre	3 Jahre

Technische Spezifikationen	RK2000 Pro	RK1000 Pro
Modellnummer	22AKHFA619	22AKFAFA619
Empfohlene Rasenfläche [m ²]	Bis zu 2.000 m ²	Bis zu 1.000 m ²
Schnittbreite [cm]	21	21
Schnitthöhe [mm]	20-100	20-100
Nebenzonen/Startpunkte	4	4
Separate Zonen	2	2
Draht [m]	×	×
Anzahl Rasennägel	×	×
Mähroboter-Motoren	DC Bürstenloser Motor	DC Bürstenloser Motor
Antriebsmotoren	DC Bürstenloser Motor	DC Bürstenloser Motor
Max. Neigung im Mähbereich	45% (24°)	45% (24°)
Max. Neigung Draht am Gefälle	20% (11°)	20% (11°)
Schalldruckpegel Lpa dB(A) (K=3)	50	50
Gemessener Schalleistungspegel Lwa, dB(A)	61	61
Garantierter Schalleistungspegel Lwa, dB(A)	64	64
Mähdauer [Min.]	100-120	50-60
Ladezeit [Min.]	60-120	60-120
Batterietyp	18,15 V Li-Ion	18,15 V Li-Ion
Spez. Akkukapazität [Ah]	4.9	2.8
Stromverbrauch [kWh/Monat]	5.1	2.8
Diebstahlsicherung	✓	✓
Bluetooth (BLE)	✓	✓
GSM-Modul	✓	✓
Nahe Draht folg. (MBLE/IR)	✓	✓
Max. Höhe	3.000 m	3.000 m
Garantie	3 Jahre	3 Jahre

EU-Konformitätserklärung

DE

Produkte, die mit dieser Erklärung abgedeckt werden:

18 Volt batteriebetriebene Rasenmäherrobotermodelle mit Ladestationsmodellen: Robomow RK1000 und RK2000, gegebenenfalls mit nachgestelltem „Pro“, mit Seriennummer aus dem Jahr 2020 ab Woche 46 und später. (Das Jahr und die Woche werden auf dem Produktetikett mit den Stellen drei bis sechs ausgewiesen: RK2046...)

MTD Products AG erklärt, dass die oben angegebenen Produkte die Anforderungen der folgenden EU-Richtlinien und der entsprechenden harmonisierten Standards erfüllen:

Directive 2006/42/EC - EN 60335-1:2012+AC:2014+A11:2014+A13:2017+A1:2019+A2:2019+A14:2019,

EN 50636-2-107:2015+A1:2018+A2:2020.

Directive 2014/53/EU - EN 303 447 V1.2.0 (draft), EN 300 328 V2.2.2,

EN 301 511 V12.5.1, EN 62311:2008, und

Erwähnt in 2014/30/EU - EN 55014-1:2017,

EN 55014-2:2015,

EN 61000-3-2:2014,

EN 61000-3-3:2013,

EN 301489-1 V2.2.3,

EN 301489-3 V2.1.1,

EN 301489-17 V3.2.4,

EN 301489-52 V1.1.0.

Directive 2000/14/EC.

Directive 2011/65/EU.

Directive 2012/19/EU.

Die Produkte wurden in Übereinstimmung mit den folgenden Standards entwickelt:

IEC 60335-1:2016 (Edition 5.2), IEC 60335-2-107:2017 (Edition 2.0)

Benannte Stelle zur Bewertung durch TÜV Rheinland LGA wurde für Artikel 3.2 der Richtlinie 2014/53/EU vorgenommen, EU-Typ Zertifikatsnummer RT 60152438 0001

Bevollmächtigter für Dokumente:

Dipl.- Ing. (FH) Bernd Staudt

Jason L. Zielke

VP Produktentwicklung - EMEA

Saarbrücken, 8 Nov. 2020

Unterschrift

RED 2014/53/EU Info

DE

In diesen Produkten kommen Funksender zum Einsatz.
Die technischen Daten sind in der folgenden Tabelle aufgeführt.

Tx Typ	Frequenz	Max. Leistung
BLE	2402 – 2480 MHz	< 6 mW
GSM EGSM900	880,2 – 914,8 MHz	< 2,29 W
GSM DSC1800	1710,2 – 1784,8 MHz	< 1,38 W
SRD	3 – 8 kHz	< 73,2 dBuA/m bei 10 m

Ersatzteile

Teile-Nr.	Teilebeschreibung
725-14826	Akku für RK1000
725-14827	Akku für RK2000
122-100-619	Ersatzmesser
742-05538	Einzelmesser
725-12966	Netzteil für RK1000 EU
725-12565	Netzteil für RK2000 EU

Maintenance et nettoyage



La sécurité d'abord

1. Éteignez le robot
2. Retirez le dispositif de désactivation avant d'effectuer toute opération de maintenance.

FR

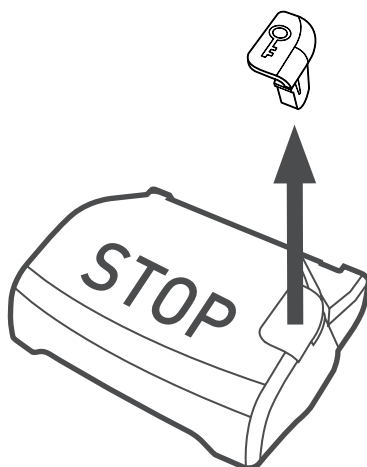
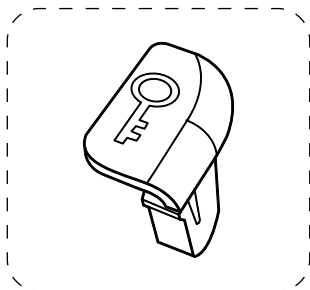
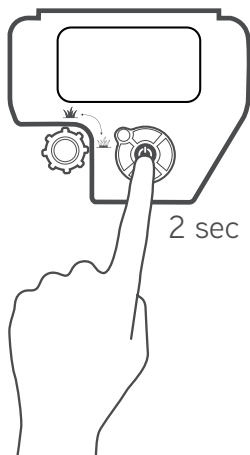

Remplacement des lames

Inspectez régulièrement les lames et remplacez-les si elles sont endommagées.

Il est recommandé de remplacer les lames conformément au tableau ci-dessous.

Remplacez toujours les 4 lames, y compris les vis



< 500 m ²	Toutes les 8 - 10 semaines
500 m ² - 1000 m ²	Toutes les 6 - 8 semaines
> 1000 m ²	Toutes les 4 - 6 semaines

Regardez la vidéo

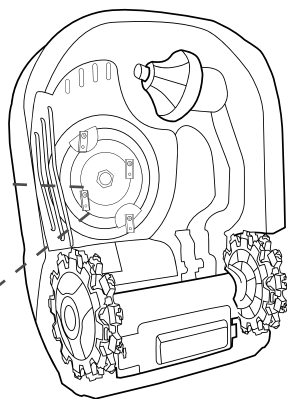
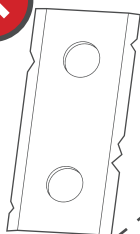
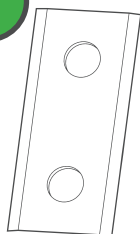

Nettoyage

Les roues et le châssis du modèle RK sont autonettoyants. L'herbe, la terre et les débris accumulés se disperseront lorsque le temps redeviendra sec. Toutes les 1 à 2 semaines, nettoyez le dessous du robot.

FR

Retirez les débris
des roues

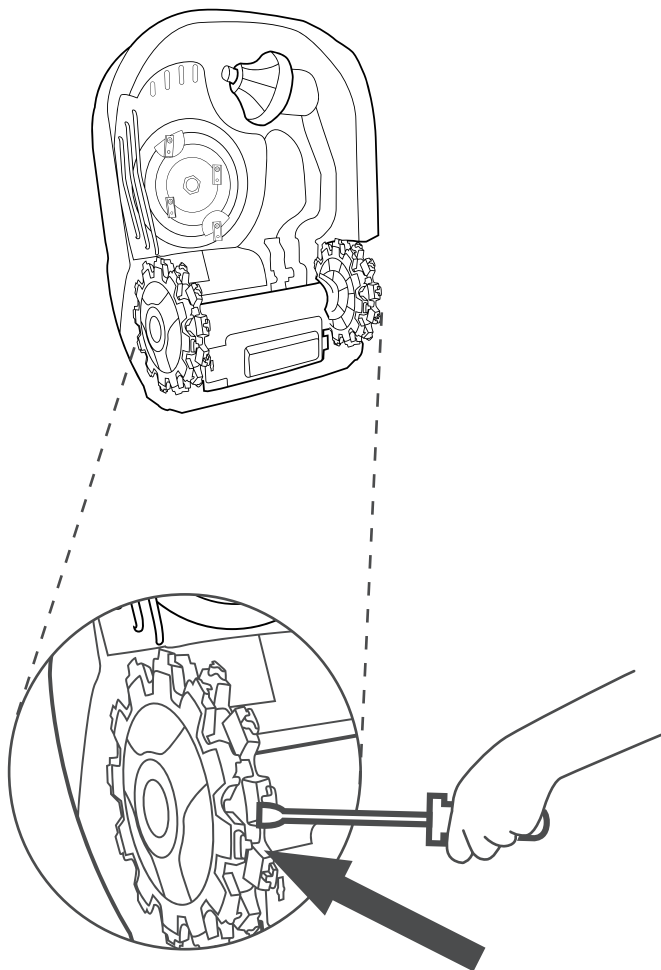

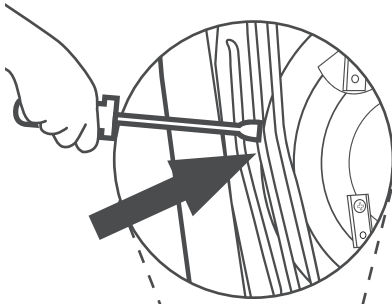

Retirez les débris
emprisonnés entre les
fils de protection

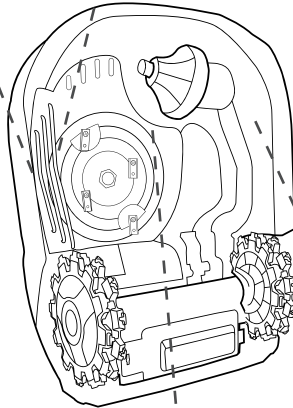

Utilisez une brosse douce
pour retirer les débris du
châssis de tonte

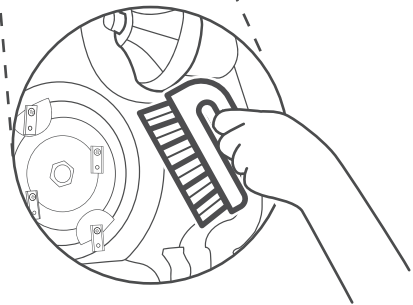

Installez les nettoyeurs de roues

Par temps humide persistant, de la boue et des fragments d'herbe peuvent s'accumuler sur les roues. Dans ces conditions, il est conseillé de fixer les nettoyeurs de roues pour retirer plus facilement les débris.

FR

Regardez la vidéo

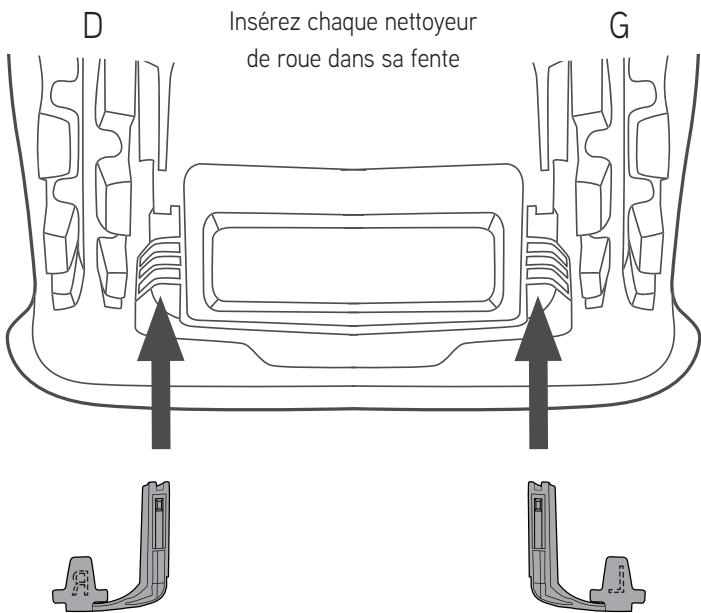
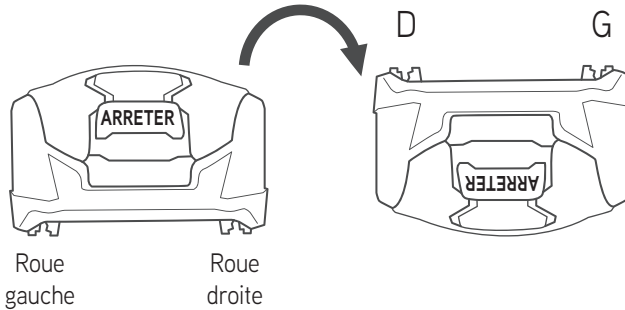

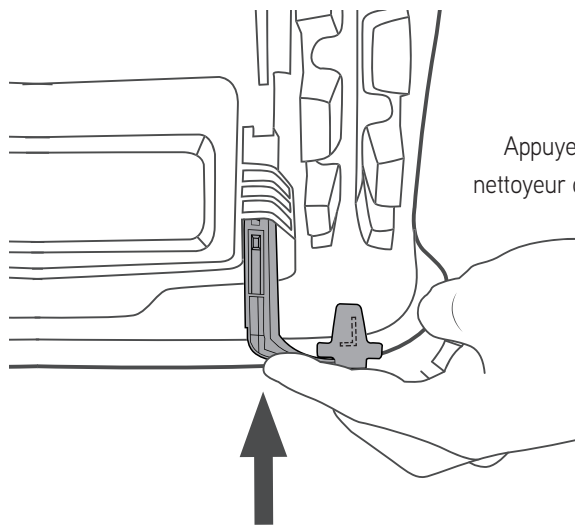

Appuyez fermement sur le nettoyeur de roue jusqu'à ce qu'il s'enclenche

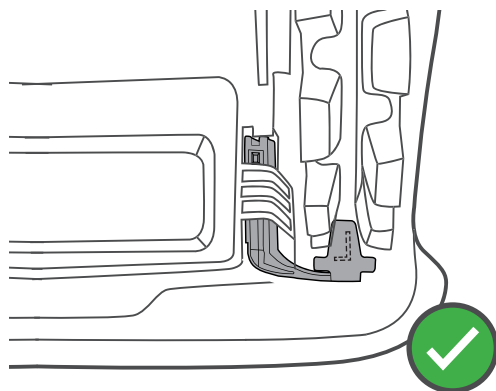

Caractéristiques techniques	RK2000	RK1000
Numéro de modèle	22AKHAFB619	22AKFAFB619
Surface de pelouse recommandée [m ²]	Jusqu'à 2000 m ²	Jusqu'à 1000 m ²
Largeur de coupe [cm]	21	21
Hauteur de coupe [mm]	20-100	20-100
Zones secondaires / Points de départ	4	4
Zones séparées	2	2
Câble [m]	300	225
Nombre de piquets	400	300
Moteurs de tonte	Sans charbons	Sans charbons
Moteurs de traction	Sans charbons	Sans charbons
Inclinaison max de la zone de tonte	45 % (24°)	45 % (24°)
Inclinaison max du câble sur la pente	20 %	20 %
Niveau de pression sonore Lpa dB(A) (K=3)	50	50
Niveau de puissance sonore mesuré Lwa, dB(A)	61	61
Niveau de puissance sonore garanti Lwa, dB(A)	64	64
Temps de tonte [min]	100-120	50-60
Temps de charge [min]	60-120	60-120
Type de batterie	Li-Ion	Li-Ion
Capacité de la batterie [Ah]	4,9	2,8
Consommation d'énergie [kWh/mois]	5,1	2,8
Antivol	✓	✓
Bluetooth (BLE)	✓	✓
Module GSM	✗	✗
Suivi du fil (MBLE/IR)	✓	✓
Altitude max	3 000m	3 000m
Garantie	3 ans	3 ans

Caractéristiques techniques	RK2000 Pro	RK1000 Pro
Numéro de modèle	22AKHFAFA619	22AKFAFA619
Surface de pelouse recommandée [m ²]	Jusqu'à 2000 m ²	Jusqu'à 1000 m ²
Largeur de coupe [cm]	21	21
Hauteur de coupe [mm]	20-100	20-100
Zones secondaires / Points de départ	4	4
Zones séparées	2	2
Câble [m]	×	×
Nombre de piquets	×	×
Moteurs de tonte	Sans charbons	Sans charbons
Moteurs de traction	Sans charbons	Sans charbons
Inclinaison max de la zone de tonte	45 % (24°)	45 % (24°)
Inclinaison max du câble sur la pente	20 % (11°)	20 % (11°)
Niveau de pression sonore Lpa dB(A) (K=3)	50	50
Niveau de puissance sonore mesuré Lwa, dB(A)	61	61
Niveau de puissance sonore garanti Lwa, dB(A)	64	64
Temps de tonte [min]	100-120	50-60
Temps de charge [min]	60-120	60-120
Type de batterie	18,15V Li-Ion	18,15V Li-Ion
Capacité de la batterie [Ah]	4,9	2,8
Consommation d'énergie [kWh/mois]	5,1	2,8
Antivol	✓	✓
Bluetooth (BLE)	✓	✓
Module GSM	✓	✓
Suivi du fil (MBLE/IR)	✓	✓
Altitude max	3000 m	3000 m
Garantie	3 ans	3 ans

Déclaration de conformité pour l'UE

Les produits couverts par cette attestation

Modèles de tondeuse robot avec station équipés d'une batterie de 18 Volts : Robomow RK1000 et RK2000, éventuellement suivis de « Pro », dont les numéros de série sont datés de la semaine 46 de l'année 2020 et ultérieures (l'année et la semaine sont indiquées sur l'étiquette du produit par les chiffres trois à six : RK2046...)

MTD Products AG atteste que les produits spécifiés ci-dessus sont conformes aux directives européennes ci-dessous et à leurs normes harmonisées :

Directive 2006/42/EC - EN 60335-1:2012+AC:2014+A11:2014+A13:2017+A1:2019+A2:2019+A14:2019,

EN 50636-2-107:2015+A1:2018+A2:2020.

Directive 2014/53/EU - EN 303 447 V1.2.0 (draft), EN 300 328 V2.2.2,

EN 301 511 V12.5.1, EN 62311:2008, et

Mentionné dans 2014/30/EU - EN 55014-1:2017,

EN 55014-2:2015,

EN 61000-3-2:2014,

EN 61000-3-3:2013,

EN 301489-1 V2.2.3,

EN 301489-3 V2.1.1,

EN 301489-17 V3.2.4,

EN 301489-52 V1.1.0.

Directive 2000/14/EC.

Directive 2011/65/EU.

Directive 2012/19/EU.

Les produits ont été développés conformément aux normes suivantes :

IEC 60335-1:2016 (Edition 5.2), IEC 60335-2-107:2017 (Edition 2.0)

Évaluation par organisme agréé effectuée par TUV Rheinland LGA (numéro de certificat RT européen 60152438 0001) pour l'Article 3.2 de la Directive 2014/53/UE

Représentant autorisé pour les documents :

M. Bernd Staudt, Ingén. dipl. (FH)

Jason L. Zielke

Vice-président Développement produits - EMEA

Sarrebruck, le 8 novembre 2020

signature

Informations RED 2014/53/UE

Ces produits utilisent des émetteurs radio.
Les caractéristiques techniques sont indiquées dans le tableau ci-dessous.

Type de transmission	Fréquence	Puissance max
BLE	2402 - 2480 MHz	< 6 mW
GSM EGSM900	880,2 - 914,8 MHz	< 2,29 W
GSM DSC1800	1710,2 - 1784,8 MHz	< 1,38 W
SRD	3 - 8kHz	<73,2 dBuA/m à 10m

FR

Pièces de rechange

Référence	Description de la pièce
725-14826	Batterie pour RK1000
725-14827	Batterie pour RK2000
122-100-619	Kit de lame
742-05538	Lame unique
725-12966	Alimentation pour RK1000 EU
725-12565	Alimentation pour RK2000 EU

Onderhoud en schoonmaak



1. Schakel de robot uit
2. Verwijder de veiligheidsleutel voor u onderhoud uitvoert

NL

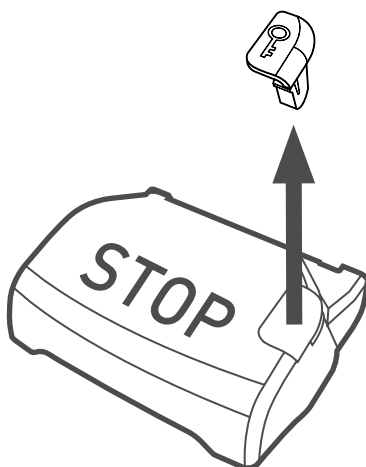
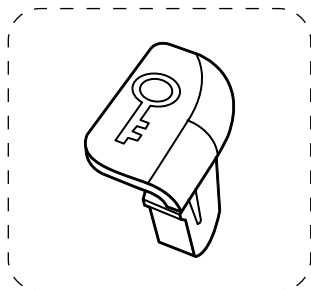
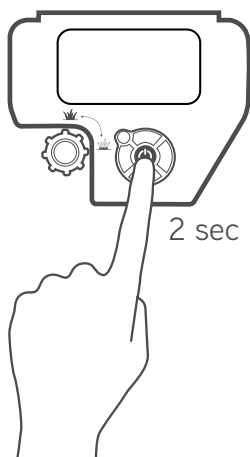

Messen vervangen

Inspecteer de messen regelmatig en vervang ze als ze beschadigd zijn. Het wordt aanbevolen om de messen volgens de onderstaande tabel te vervangen.

Vervang altijd alle 4 de messen, met inbegrip van de schroeven



NL

< 500 m ²	Elke 8 - 10 weken
500 m ² - 1000 m ²	Elke 6 - 8 weken
> 1000 m ²	Elke 4 - 6 weken

Bekijk de video

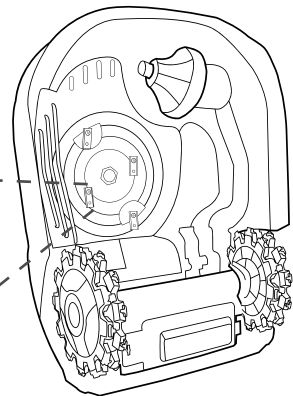
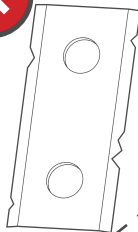
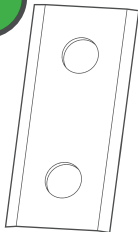

Schoonmaak

De wielen en het maaidek van de RK zijn zelfreinigend. Gras, grond en resten zullen wegvallen wanneer het weer droog wordt.

Maak de onderzijde van de robot elke 1-2 weken schoon.

NL

Verwijder resten
van de wielen

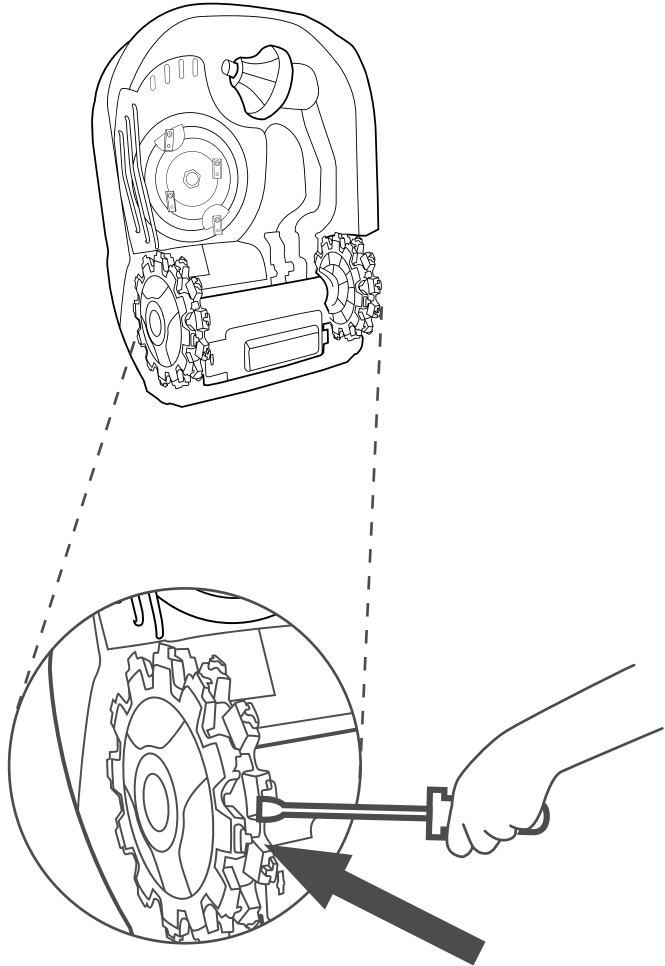

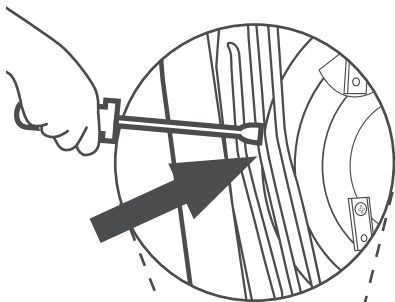

Verwijder resten uit de veiligheidsdraden

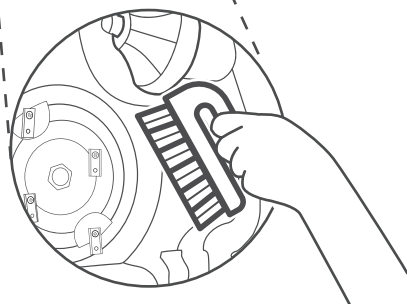
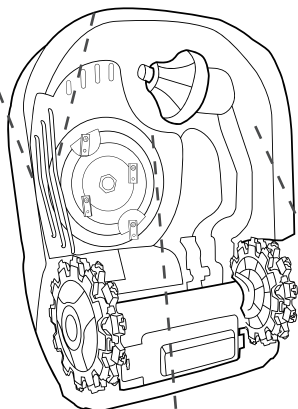

Gebruik een zachte borstel om resten van het maaidek te verwijderen

De wielreinigers installeren

Tijdens langdurige natte perioden kunnen modder en maaisel zich op de wielen verzamelen. In deze omstandigheden is het aanbevolen de wielreinigers te installeren om resten beter te verwijderen.

Bekijk de video



NL

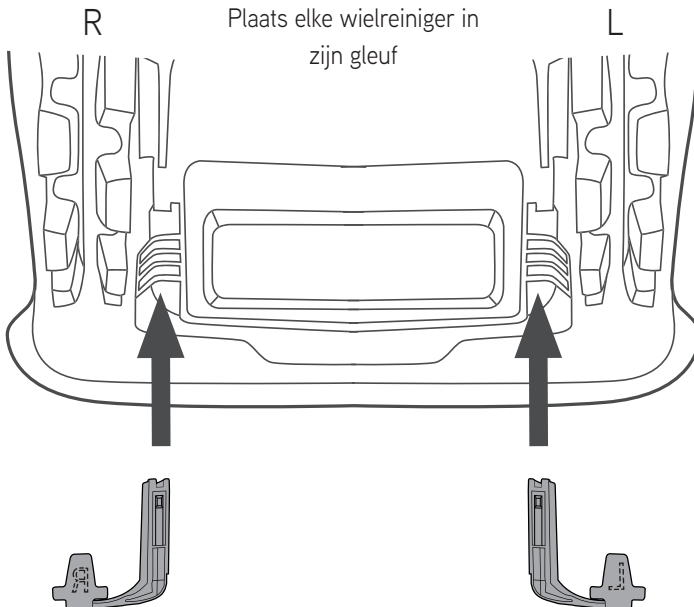
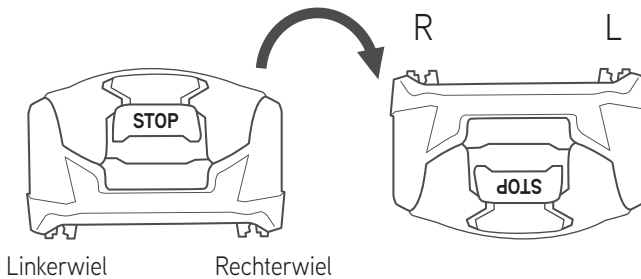

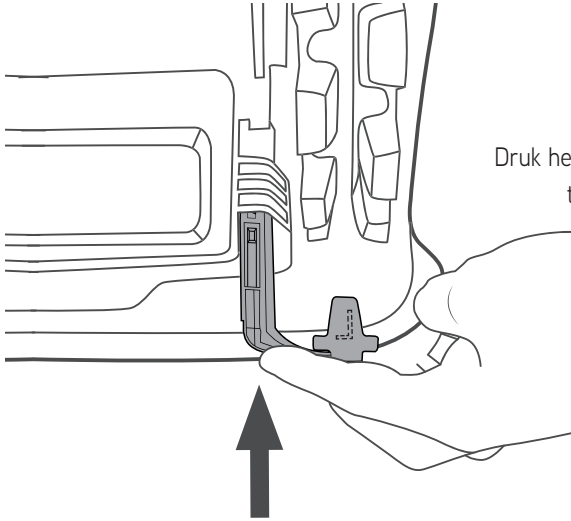

Druk hem stevig in de gleuf
tot hij vastzit

NL

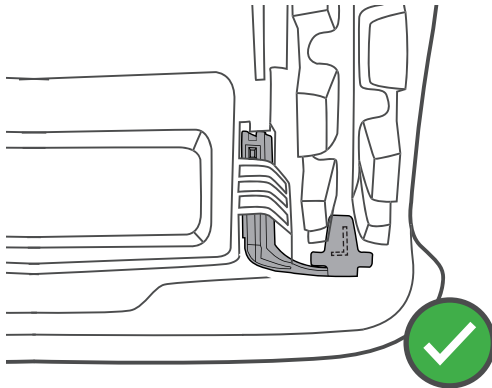

Technische specificaties	RK2000	RK1000
Modelnummer	22AKHAFB619	22AKFAFB619
Aanbevolen gazongrootte [m ²]	Tot 2000 m ²	Tot 1000 m ²
Maaibreedte [cm]	21	21
Maihoogte [mm]	20-100	20-100
Subzones / vertrekpunten	4	4
Aparte zones	2	2
Draad [m]	300	225
Aantal pinnen	400	300
Maaimotoren	DC motoren, borstelloos	DC motoren, borstelloos
Rijmotoren	DC motoren, borstelloos	DC motoren, borstelloos
Max. helling maaizone	45% (24°)	45% (24°)
Max. helling draad op helling	20%	20%
Geluidsdruk Lpa dB(A) (K=3)	50	50
Gemeten geluidsniveau Lwa, dB(A)	61	61
Gewaarborgd geluidsniveau Lwa, dB(A)	64	64
Maaitijd [min]	100-120	50-60
Laadtijd [min]	60-120	60-120
Accu type	Li-Ion	Li-Ion
Accucapaciteit [Ah]	4,9	2,8
Stroomverbruik [kWh/maand]	5,1	2,8
Diefstalbeveiliging	✓	✓
Bluetooth (BLE)	✓	✓
Gsm-module	✗	✗
Volgen bij draad (MBLE/IR)	✓	✓
Max. hoogte	3.000 m	3.000 m
Garantie	3 jaar	3 jaar

NL

Technische specificaties	RK2000 Pro	RK1000 Pro
Modelnummer	22AKHAF619	22AKFAFA619
Aanbevolen gazongrootte [m ²]	Tot 2000 m ²	Tot 1000 m ²
Maaibreedte [cm]	21	21
Maaihogte [mm]	20-100	20-100
Subzones / vertrekpunten	4	4
Aparte zones	2	2
Draad [m]	×	×
Aantal pinnen	×	×
Maaimotoren	DC motoren, borstelloos	DC motoren, borstelloos
Rijmotoren	DC motoren, borstelloos	DC motoren, borstelloos
Max. helling maaizone	45% (24°)	45% (24°)
Max. helling draad op helling	20% (11°)	20% (11°)
Geluidsdruk Lpa dB(A) (K=3)	50	50
Gemeten geluidsniveau Lwa, dB(A)	61	61
Gewaarborgd geluidsniveau Lwa, dB(A)	64	64
Maaitijd [min]	100-120	50-60
Laadtijd [min]	60-120	60-120
Accu type	18,15 V Li-Ion	18,15 V Li-Ion
Accucapaciteit [Ah]	4,9	2,8
Stroomverbruik [kWh/maand]	5,1	2,8
Diefstalbeveiliging	✓	✓
Bluetooth (BLE)	✓	✓
Gsm-module	✓	✓
Volgen bij draad (MBLE/IR)	✓	✓
Max. hoogte	3.000 m	3.000 m
Garantie	3 jaar	3 jaar

EU conformiteitsverklaring

De producten die onder deze verklaring vallen

Robotmaaier met 18 V accu met basisstation, modellen: RK1000 en RK2000, mogelijk gevolgd door "Pro", met serienummer jaar 2020 week 46 en later (Het jaar en de week worden getoond op het productlabel in cijfers drie tot zes: RK2046 ...)

MTD Products AG verklaart dat de bovenvermelde producten voldoen aan de volgende EU-richtlijnen en hun geharmoniseerde normen:

NL

Directive 2006/42/EC - EN 60335-1:2012+AC:2014+A11:2014+A13:2017+A1:2019+A2:2019+A14:2019,

EN 50636-2-107:2015+A1:2018+A2:2020.

Directive 2014/53/EU - EN 303 447 V1.2.0 (draft), EN 300 328 V2.2.2,

EN 301 511 V12.5.1, EN 62311:2008, en

Vermeld in 2014/30/EU - EN 55014-1:2017,

EN 55014-2:2015,

EN 61000-3-2:2014,

EN 61000-3-3:2013,

EN 301489-1 V2.2.3,

EN 301489-3 V2.1.1,

EN 301489-17 V3.2.4,

EN 301489-52 V1.1.0.

Directive 2000/14/EC.

Directive 2011/65/EU.

Directive 2012/19/EU.

De producten zijn volgens de onderstaande normen ontwikkeld:

IEC 60335-1:2016 (Editie 5.2), IEC 60335-2-107:2017 (Editie 2.0)

Beoordeling door de aangemelde instantie TUV Rheinland LGA (certificaat nummer RT 60152438 0001) volgens Artikel 3.2 van de Richtlijn 2014/53/EU

Geautoriseerde vertegenwoordiger voor documenten:

Naam van de vertegenwoordiger Gedipl. Ing. (FH) Mr. Bernd Staudt

Jason L. Zielke

VP Product Development - EMEA

Saarbrücken, 8 Nov 2020

Jason L Zielke
signature

RED 2014/53/EU info

Deze producten gebruiken radiozenders
De onderstaande tabel vermeldt de specificaties.

Tx-type	Frequentie	Max. vermogen
BLE	2402 – 2480 MHz	< 6 mW
GSM EGSM900	880,2 – 914,8 MHz	< 2,29 W
GSM DSC1800	1710,2 – 1784,8 MHz	< 1,38 W
SRD	3 – 8 kHz	< 73.2 dBuA/m @ 10 m

NL

Reserveonderdelen

Onderdeelnummer	Beschrijving van het onderdeel
725-14826	Accu voor RK1000
725-14827	Accu voor RK2000
122-100-619	Messenset
742-05538	Enkel mes
725-12966	Voeding voor RK1000 EU
725-12565	Voeding voor RK2000 EU

Manutenzione e pulizia



La sicurezza innanzitutto

1. Spegnete il robot
2. Prima di procedere alla manutenzione, rimuovete il dispositivo di disabilitazione

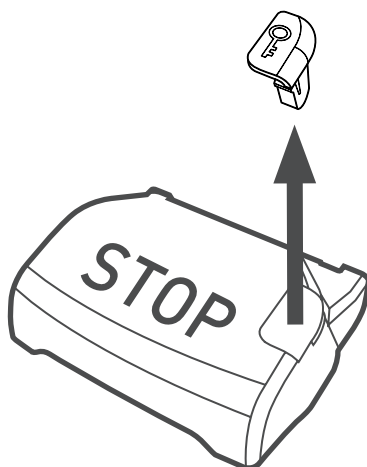
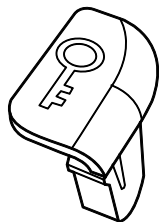
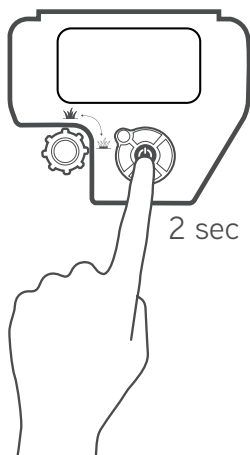

Sostituzione delle lame

Ispezionate periodicamente le lame e, se sono danneggiate, sostituitele. È consigliabile sostituire le lame come indicato nella tabella seguente. Sostituire sempre tutte e 4 le lame, comprese le viti



< 500 m ²	Ogni 8 -10 settimane
500 m ² - 1000 m ²	Ogni 6 - 8 settimane
> 1000 m ²	Ogni 4 - 6 settimane

IT

Guarda il video

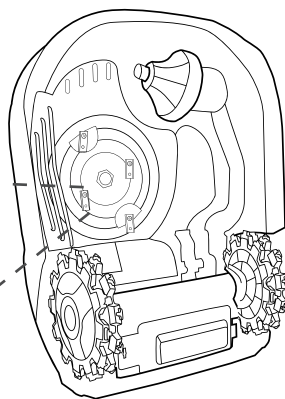
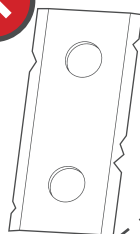
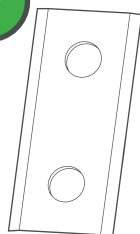

Pulizia

Le ruote RK e il piatto sono autopulenti. Gli accumuli di erba, terra e detriti si disperderanno quando torneranno condizioni di siccità.

Ogni 1-2 settimane, pulire il fondo del robot.

IT

Rimuovere i detriti
dalle ruote

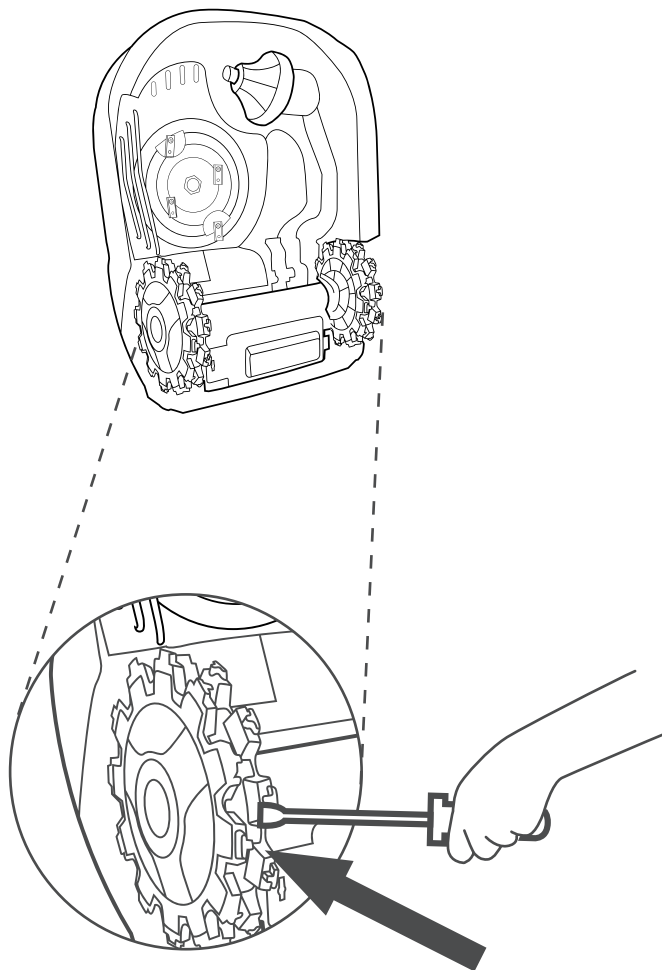

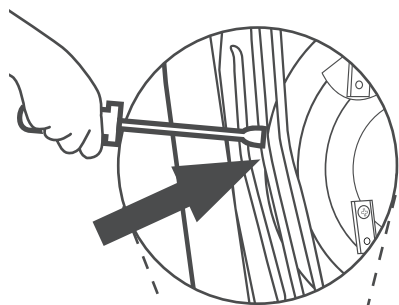

Rimuovere i detriti tra i
cavi di protezione

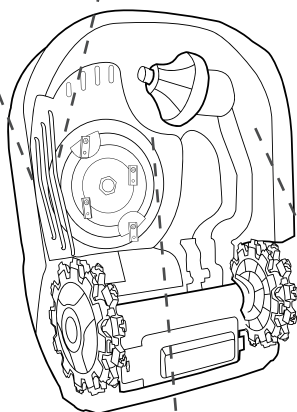

Per rimuovere i detriti dal
piano di taglio, usare una
spazzola morbida

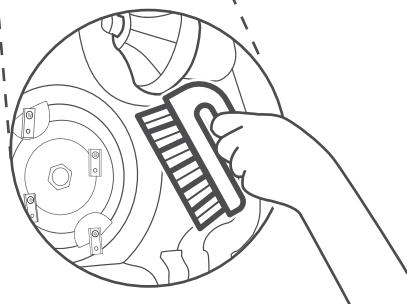

Installate gli accessori per la pulizia delle ruote

Durante i lunghi periodi di condizioni di bagnato, il fango e il pacciame possono accumularsi sulle ruote. Per rimuovere i detriti in queste condizioni è consigliabile applicare gli accessori per la pulizia delle ruote.

Guarda il video



IT

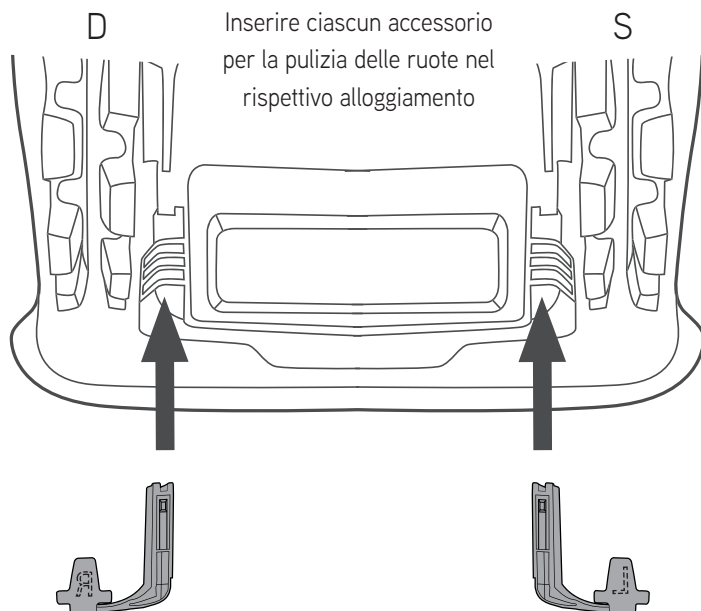
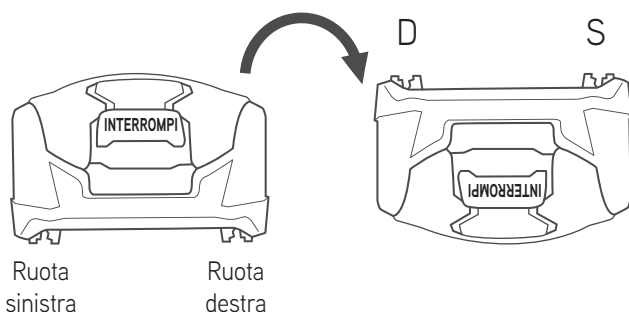

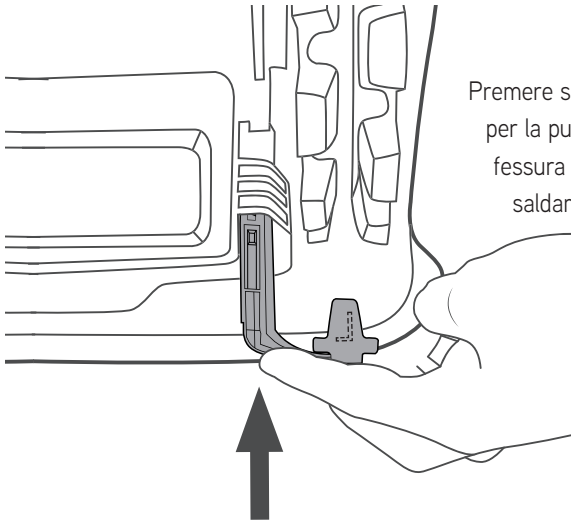

Premere saldamente l'accessorio per la pulizia delle ruote nella fessura fino a quando non è saldamente in posizione

IT

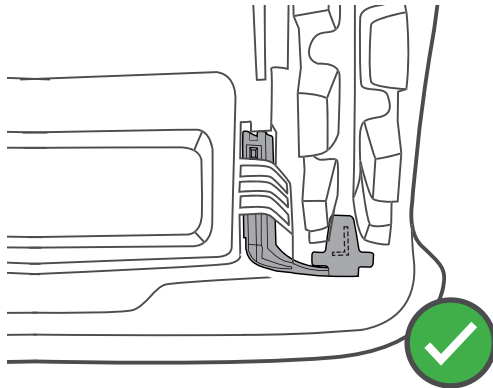

Specifiche tecniche	RK2000	RK1000
Numero modello	22AKHAFB619	22AKFAFB619
Dimensioni prato consigliate [m ²]	Fino a 2000 m ²	Fino a 1000 m ²
Larghezza di taglio [cm]	21	21
Altezza di taglio [mm]	20-100	20-100
Sottozone/punti di partenza	4	4
Zone separate	2	2
Cavo [m]	300	225
Numero di picchetti	400	300
Motori di taglio	Senza spazzola CC	Senza spazzola CC
Motori di trazione	Senza spazzola CC	Senza spazzola CC
Inclinazione massima area di taglio	45% (24°)	45% (24°)
Inclinazione massima cavo su pendenza	20%	20%
Livello di pressione acustica Lpa(A) (K=3)	50	50
Livello di pressione acustica misurato Lwa, dB (A)	61	61
Livello di pressione acustica garantito Lwa, dB (A)	64	64
Tempo di taglio [min]	100-120	50-60
Tempo di carica [min]	60-120	60-120
Tipo di batterie	Ioni di litio	Ioni di litio
Specifiche capacità batteria [Ah]	4.9	2.8
Consumo energetico [kWh/mese]	5.1	2.8
Antifurto	✓	✓
Bluetooth (BLE)	✓	✓
Modulo GSM	✗	✗
Segui cavo da vicino (MBLE/IR)	✓	✓
Altitudine massima	3.000 m	3.000 m
Garanzia	3 anni	3 anni

Specifiche tecniche	RK2000 Pro	RK1000 Pro
Numero modello	22AKHFA619	22AKFAFA619
Dimensioni prato consigliate [m ²]	Fino a 2000 m ²	Fino a 1000 m ²
Larghezza di taglio [cm]	21	21
Altezza di taglio [mm]	20-100	20-100
Sottozone/punti di partenza	4	4
Zone separate	2	2
Cavo [m]	×	×
Numero di picchetti	×	×
Motori di taglio	Senza spazzola CC	Senza spazzola CC
Motori di trazione	Senza spazzola CC	Senza spazzola CC
Inclinazione massima area di taglio	45° (24°)	45° (24°)
Inclinazione massima cavo su pendenza	20° (11°)	20° (11°)
Livello di pressione acustica Lpa(A) (K=3)	50	50
Livello di pressione acustica misurato Lwa, dB (A)	61	61
Livello di pressione acustica garantito Lwa, dB (A)	64	64
Tempo di taglio [min]	100-120	50-60
Tempo di carica [min]	60-120	60-120
Tipo di batterie	18,15 V - Ioni di litio	18,15 V - Ioni di litio
Specifiche capacità batteria [Ah]	4,9	2,8
Consumo energetico [kWh/mese]	5,1	2,8
Antifurto	✓	✓
Bluetooth (BLE)	✓	✓
Modulo GSM	✓	✓
Segui cavo da vicino (MBLE/IR)	✓	✓
Altitudine massima	3.000 m	3.000 m
Garanzia	3 anni	3 anni

Dichiarazione di conformità UE

Prodotti coperti da questa dichiarazione

Modelli di robot rasaerba alimentati da una batteria da 18 Volt: Robomow RK1000 e RK2000, possono essere seguiti dall'indicazione "Pro", con numero di serie che risale alla 46 settimana del 2020 in avanti (l'anno e la settimana sono indicati sull'etichetta del prodotto, nelle cifre da tre a sei: RK2046...)

MTD Products AG dichiara che i prodotti sopra identificati sono conformi alle seguenti direttive UE e agli standard armonizzati:

Directive 2006/42/EC - EN 60335-1:2012+AC:2014+A11:2014+A13:2017+A1:2019+A2:2019+A14:2019,

EN 50636-2-107:2015+A1:2018+A2:2020.

Directive 2014/53/EU - EN 303 447 V1.2.0 (draft), EN 300 328 V2.2.2,

EN 301 511 V12.5.1, EN 62311:2008, e

Citati nella direttiva 2014/30/EU - EN 55014-1:2017,

EN 55014-2:2015,

EN 61000-3-2:2014,

EN 61000-3-3:2013,

EN 301489-1 V2.2.3,

EN 301489-3 V2.1.1,

EN 301489-17 V3.2.4,

EN 301489-52 V1.1.0.

Directive 2000/14/EC.

Directive 2011/65/EU.

Directive 2012/19/EU.

I prodotti sono stati sviluppati in conformità con gli standard seguenti:

IEC 60335-1:2016 (Edizione 5.2), IEC 60335-2-107:2017 (Edizione 2.0)

La valutazione dell'organismo notificato da parte di TUV Rheinland LGA (numero certificato RT 60152438 0001) è stata effettuata per l'articolo 3.2 della direttiva 2014/53/UE

Rappresentante autorizzato per i documenti:

Dipl. Ing. (FH) Bernd Staudt

Jason L. Zielke

VP Product Development - EMEA

Saarbrücken, 8 novembre 2020

firma

Informazioni RED 2014/53/EU

Questi prodotti utilizzano radiotrasmittitori.
Le specifiche sono indicate nella tabella seguente.

Tipo tx	Frequenza	Potenza massima
BLE	2402 – 2480 MHz	< 6 mW
GSM EGSM900	880,2 – 914,8 MHz	< 2,29 W
GSM DSC1800	1710,2 – 1784,8 MHz	< 1,38 W
SRD	3 – 8 kHz	< 73,2 dBuA/m @ 10 m

IT

Parti di ricambi

Numero parte	Descrizione parte
725-14826	Batteria per RK1000
725-14827	Batteria per RK2000
122-100-619	Kit monolama
742-05538	Lama singola
725-12966	Alimentatore per RK1000 EU
725-12565	Alimentatore per RK2000 EU

Vedligeholdelse og rengøring



Sikkerhed først

1. Sluk for robotten
2. Fjern deaktiveringsenheden, inden du udfører vedligeholdelse

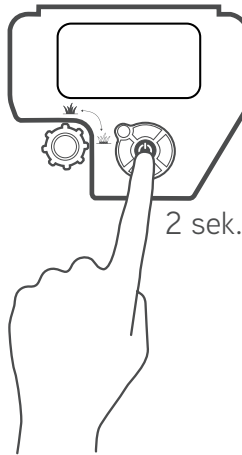

DK

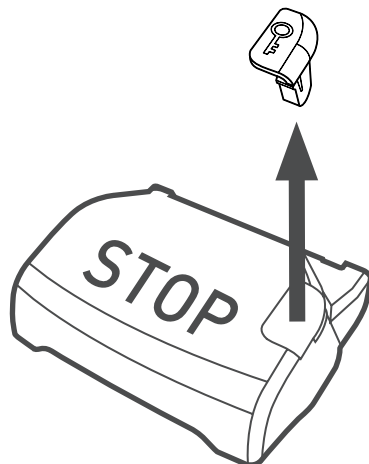
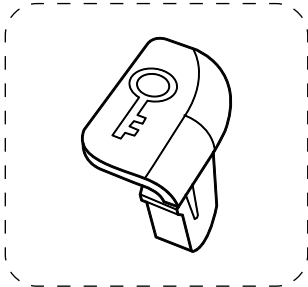

Klingeudskiftning

Undersøg knivene regelmæssigt, og udskift dem hvis de er beskadigede. Det anbefales at udskifte knivene i henhold til nedenstående tabel.

Udskift altid alle 4 knive inklusive skrueerne



< 500 m ²	Hver 8. - 10. uge
500 m ² - 1000 m ²	Hver 6. - 8. uge
> 1000 m ²	Hver 4. - 6. uge

DK

Se videoen

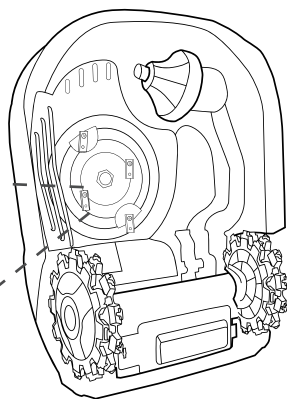
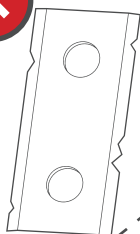
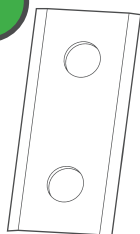

Rengøring

RK-hjulene og dækket er selvrensende. Akkumuleret græs, jord og snavs spredes, når tørre forhold vender tilbage.

Rengør robotten nedenunder hver 1-2 uge.

DK

Fjern snavs fra
hjulene

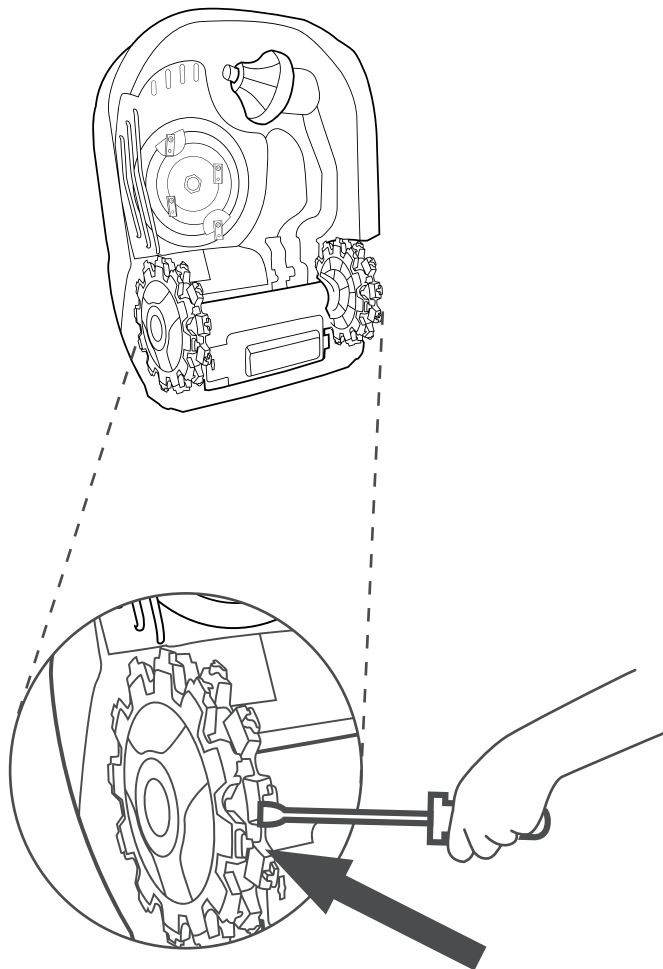

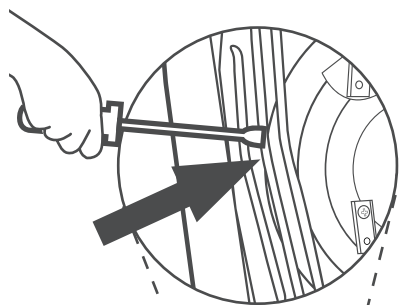

Fjern snavs mellem beskyttelsestrådene

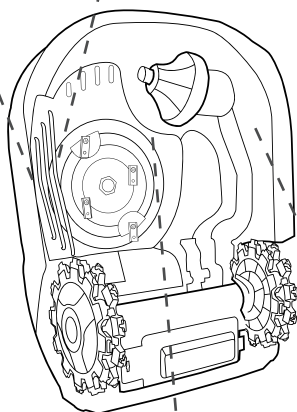

Brug en blød børste til at fjerne snavs fra klippeaggregatet

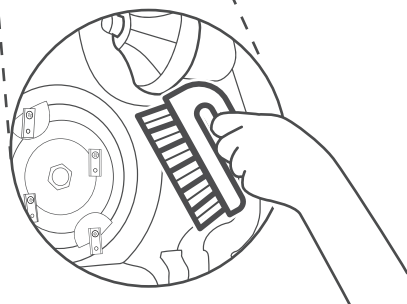

DK

Installer hjulrensere

I længere perioder med øgede våde forhold kan mudder og kompost ophobes på hjulene. Det anbefales at fastgøre tilbehør til hjulrensere for at hjælpe med at fjerne snavs under disse forhold.

Se videoen

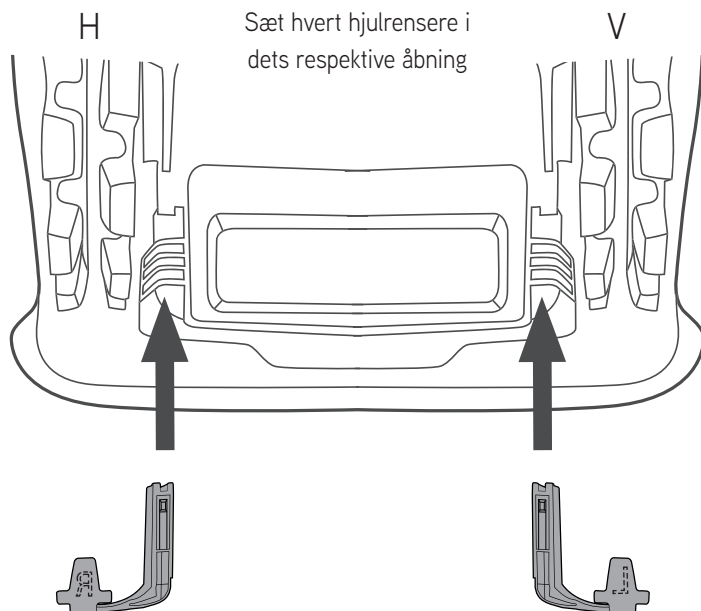
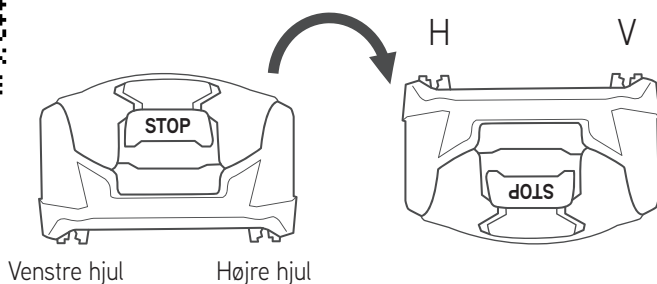

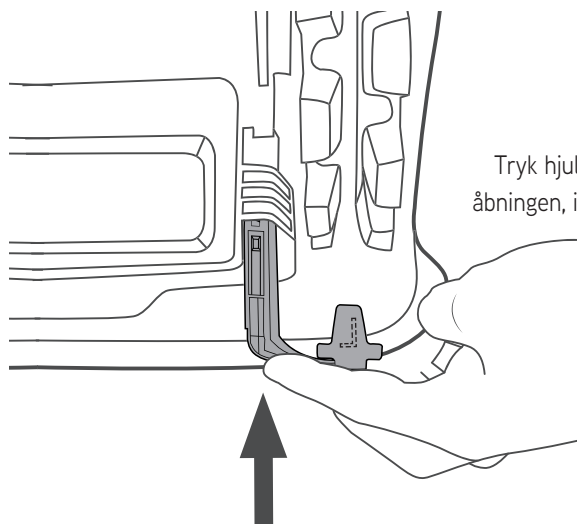

Tryk hjulrenseren bestemt ind i åbningen, indtil den sidder godt fast

DK

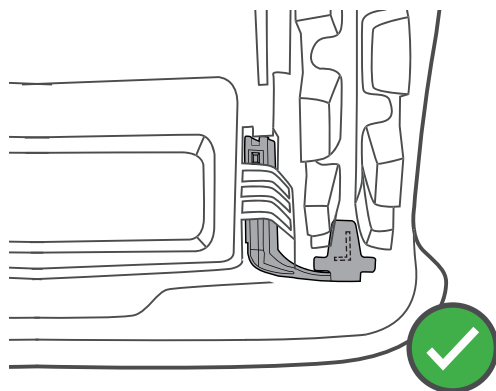

Teknisk specifikation	RK2000	RK1000
Modelnummer	22AKHAFB619	22AKFAFB619
Anbefalet plænestørrelse [m ²]	Op til 2000 m ²	Op til 1000 m ²
Klippebredde [cm]	21	21
Klippehøjde [mm]	20-100	20-100
Underzoner/udgangspunkter	4	4
Adskilte zoner	2	2
Kanttråd [m]	300	225
Antal of pløkker	400	300
Klippemotorer	DC Brushless	DC Brushless
Køremotorer	DC Brushless	DC Brushless
Max. gradient af klippområde	45% (24°)	45% (24°)
Max. gradient af kanttråden	20%	20%
Lydtryksniveau L _{pa} dB(A) (K=3)	50	50
Målt lydeffektniveau, L _{wa} , dB(A)	61	61
Garanteret lydeffektniveau, L _{wa} , dB(A)	64	64
Klippetid [min]	100-120	50-60
Opladningstid [min]	60-120	60-120
Batteritype	Li-Ion	Li-Ion
Batterikapacitet specifikation [Ah]	4.9	2.8
Strømförbrug [kWh/måned]	5.1	2.8
Tyverisikring	✓	✓
Bluetooth (BLE)	✓	✓
GSM Modul	✗	✗
Kanttrådsfølger (MBLE/IR)	✓	✓
Maksimal højde over havet	3,000	3,000
Garanti	3 år	3 år

DK

Teknisk specifikation	RK2000 Pro	RK1000 Pro
Modelnummer	22AKHAF619	22AKFAFA619
Anbefalet plænestørrelse [m ²]	Op til 2000 m ²	Op til 1000 m ²
Klippebredde [cm]	21	21
Klippehøjde [mm]	20-100	20-100
Underzoner/udgangspunkter	4	4
Adskilte zoner	2	2
Kanttråd [m]	×	×
Antal of pløkker	×	×
Klippemotorer	DC Brushless	DC Brushless
Køremotorer	DC Brushless	DC Brushless
Max. gradient af klippområde	45% (24°)	45% (24°)
Max. gradient af kanttråden	20% (11°)	20% (11°)
Lydtryksniveau L _{pa} dB(A) (K=3)	50	50
Målt lydeffektniveau, L _{wa} , dB(A)	61	61
Garanteret lydeffektniveau, L _{wa} , dB(A)	64	64
Klippetid [min]	100-120	50-60
Opladningstid [min]	60-120	60-120
Batteritype	18,15V Li-Ion	18,15V Li-Ion
Batterikapacitet specifikation [Ah]	4.9	2.8
Strømförbrug [kWh/måned]	5.1	2.8
Tyverisikring	✓	✓
Bluetooth (BLE)	✓	✓
GSM Modul	✓	✓
Kanttrådsfølger (MBLE/IR)	✓	✓
Maksimal højde over havet	3,000	3,000
Garanti	3 år	3 år



EU

Overensstemmelseserklæring

Produkterne omfattet af denne erklæring

18-volts batteridrevet robotplæneklipper med basestationsmodeller: Robomow RK1000 og RK2000, kan efterfølges af "Pro" med serienummer dateret 2020 uge 46 og fremefter (året og ugen er angivet på produktetiketten i cifrene tre til seks: RK2046...)

MTD Products AG erklærer, at produkterne præsenteret ovenfor er i overensstemmelse med følgende EU-direktiver og deres harmoniserede standarder:

Directive 2006/42/EC - EN 60335-1:2012+AC:2014+A11:2014+A13:2017+A1:2019+A2:2019+A14:2019,

EN 50636-2-107:2015+A1:2018+A2:2020.

Directive 2014/53/EU - EN 303 447 V1.2.0 (draft), EN 300 328 V2.2.2,

EN 301 511 V12.5.1, EN 62311:2008, and

Mentioned in 2014/30/EU - EN 55014-1:2017,

EN 55014-2:2015,

EN 61000-3-2:2014,

EN 61000-3-3:2013,

EN 301489-1 V2.2.3,

EN 301489-3 V2.1.1,

EN 301489-17 V3.2.4,

EN 301489-52 V1.1.0.

Directive 2000/14/EC.

Directive 2011/65/EU.

Directive 2012/19/EU.

Produkterne er blevet udviklet i overensstemmelse med følgende standarder:

IEC 60335-1: 2016 (udgave 5.2), IEC 60335-2-107: 2017 (udgave 2.0)

Vurdering af bemyndiget organ foretaget af TUV Rheinland LGA (certifikatnummer RT 60152438 0001) blev foretaget i henhold til artikel 3.2 i direktiv 2014/53 / EU

Autoriseret repræsentant for dokumenter:

Repræsentants navn Dipl. Ing. (FH) Bernd Staudt

Jason L. Zielke

VP Produktudvikling - EMEA

Saarbrücken, 8 Nov 2020

signature

RED 2014/53/EU info

Disse produkter gør brug af radiosendere.
Specifikationer kan ses i tabellen nedenfor.

Tx type	Hyppeghed	Max strømstyrke
BLE	2402–2480 MHz	< 6 mW
GSM EGSM900	880,2–914,8 MHz	< 2.29 W
GSM DSC1800	1710,2 – 1784,8 MHz	< 1.38 W
SRD	3–8 kHz	<73,2 dBuA/m @ 10m

Reserve dele

DK

Reserve delnummer	Delbeskrivelse
725-14826	Batteri til RK1000
725-14827	Batteri til RK2000
122-100-619	Klingesæt
742-05538	Enkelt klinge
725-12966	Strømforsyning til RK1000 EU
725-12565	Strømforsyning til RK2000 EU

Huolto ja puhdistaminen



Turvallisuus ensin

1. Sammuta robotti
2. Poista estolaite ennen kuin teet mitään huoltotöitä

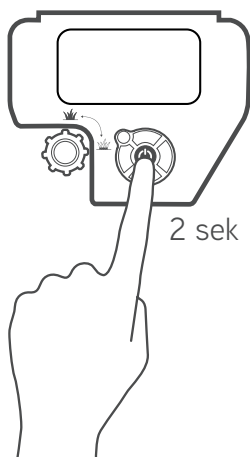

FI

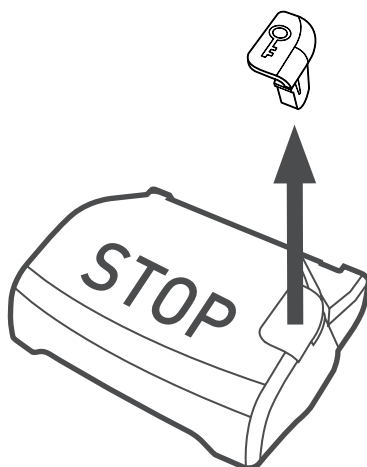
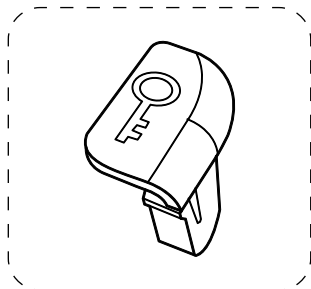

Terien vaihto

Tarkista terät säännöllisesti ja vaihda ne, jos ne ovat vahingoittuneet. Suositellaan, että terien vaihto tehdään alla olevan taulukon mukaan. Vaihda aina kaikki 4 terää, myös ruuvit.



< 500 m ²	8-10 viikon välein
500 m ² - 1000 m ²	6-8 viikon välein
> 1000 m ²	4-6 viikon välein

Katso video

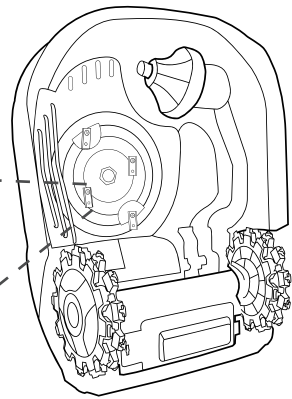
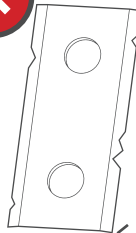
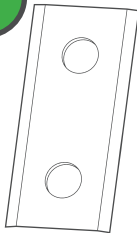

Puhdistaminen

RK:n renkaat ja kansi ovat itsepuhdistuvia. Kerääntynyt ruoho, multa ja jäänteet leviävät pois, kun olosuhteet ovat taas kuivat.

Puhdista robotin alapuoli 1-2 viikon välein.

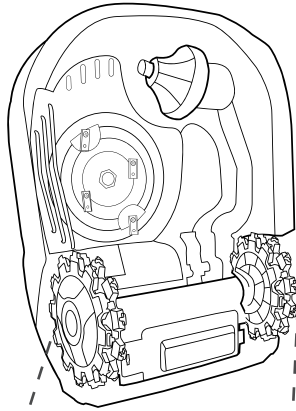

FI

Poista jäänteet
renkaista.

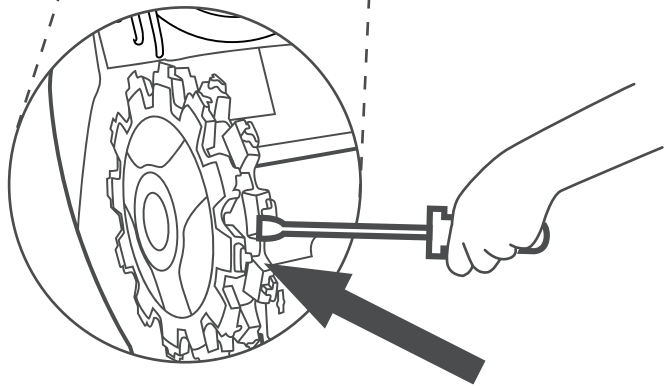

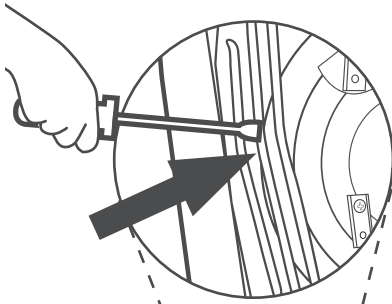

Poista jäänteet
suojalankojen välistä

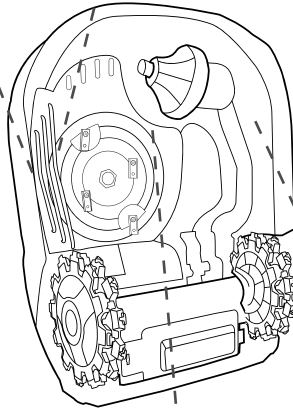

Poista jäänteet leikkuukannelta
pehmeällä harjalla

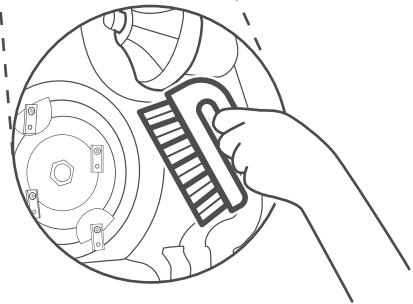

Asenna renkaiden puhdistuslaitteet

Jos olosuhteet ovat kosteita pidempään, renkaisiin saattaa kerääntyä mutaa ja lehtiä. Näissä olosuhteissa suositellaan, että ruohonleikkuriin liitetään pyörien puhdistuslaitteet, jotta jäänteet puhdistuisivat pois tehokkaammin.

Katso video

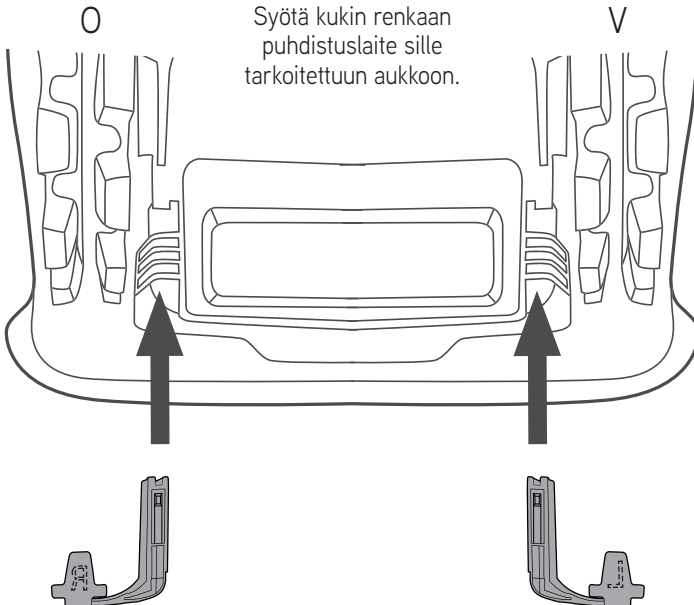
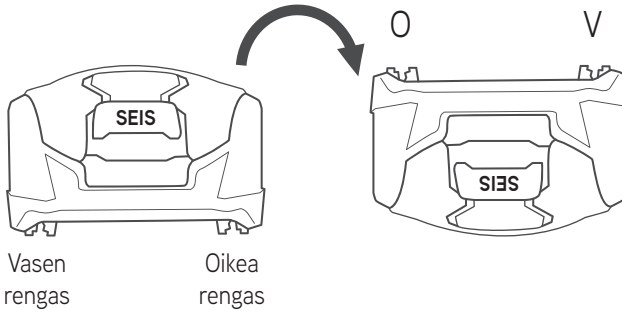

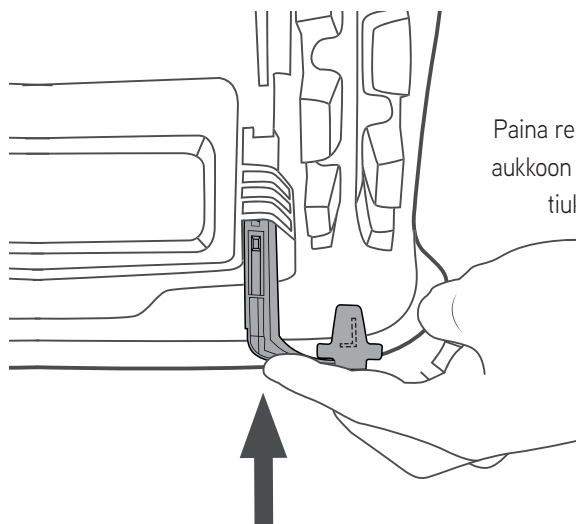

Paina renkaan puhdistuslaite
aukkoon lujasti, kunnes se on
tiukasti paikallaan

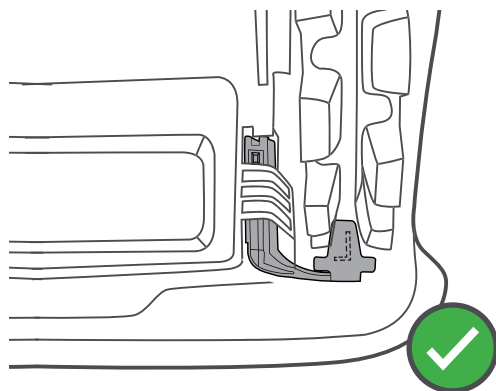

FI

Tekniset Eritelmät	RC2000	RC1000
Mallin numero	22AKHAFB619	22AKFAFB619
Suosittelunurmikokoko [m ²]	2000 m ² asti	1000 m ² asti
Leikkuuleveys [cm]	16.	16.
Leikkuukorkeus [mm]	20-100	20-100
Lisävyöhykkeet / aloituspisteet	4	4
Erillisalueet	2	2
Johto [m]	300	225
Kiinnikkeiden määrä	400	300
Leikkuumootorit	DC-harjaton	DC-harjaton
Ajomootorit	DC-harjaton	DC-harjaton
Leikkuaueenmaksimikallistuma	45 % (24°)	45 % (24°)
Johdonmaksimikallistumarinteessä	20%	20%
Äänenpainetaso L _{pa} dB(A) (K=3)	50	50
Mitattu äänitehotaso L _{wa} , dB(A)	61	61
Taattu äänitehotaso L _{wa} , dB(A)	64	64
Leikkuaika [min]	100-120	50-60
Latausaika [min]	60-120	60-120
Akun tyyppi	Li-Ion	Li-Ion
Akun kapasiteetin määritelmät [Ah]	4.9	2.8
Virrankulutus [kWh/kuukausi]	5.1	2.8
Varashälytys	✓	✓
Bluetooth (BLE)	✓	✓
GSM-moduuli	✗	✗
Johdinseuraaja (mobiili/infrapuna)	✓	✓
Maksimikorkeus	3 000 m	3 000 m
Takuu	3 vuotta	3 vuotta

FI

Tekniset määritelmät	RK2000 Pro	RK1000 Pro
Mallin numero	22AKHAF619	22AKFAFA619
Suosittelunurmikokoko [m ²]	2000 m ² asti	1000 m ² asti
Leikkuuleveys [cm]	16.	16.
Leikkuukorkeus [mm]	20-100	20-100
Lisävyöhykkeet / aloituspisteet	4	4
Erillisalueet	2	2
Johto [m]	×	×
Kiinnikkeiden määrä	×	×
Leikkuumoottorit	DC-harjaton	DC-harjaton
Ajomoottorit	DC-harjaton	DC-harjaton
Leikkualueen maksimikallistuma	45 % (24°)	45 % (24°)
Johdon maksimikallistuma rinteessä	20 % (11°)	20 % (11°)
Äänenpainetaso L _{pa} dB(A) (K=3)	50	50
Mitattu äänitehotaso L _{wa} , dB(A)	61	61
Taattu äänitehotaso L _{wa} , dB(A)	64	64
Leikkuaika [min]	100-120	50-60
Latausaika [min]	60-120	60-120
Akun tyyppi	18,15V Li-Ion	18,15V Li-Ion
Akun kapasiteetin määritelmät [Ah]	4.9	2.8
Virrankulutus [kWh/kuukausi]	5.1	2.8
Varashälytin	✓	✓
Bluetooth (BLE)	✓	✓
GSM-moduuli	✓	✓
Johdinseuraaja (mobiili/infrapuna)	✓	✓
Maksimikorkeus	3 000 m	3 000 m
Takuu	3 vuotta	3 vuotta

EU-vaatimustenmukaisuus- vakuutus

Tämä todistus kattaa seuraavat tuotteet

18 Voltin Akkutoiminen Robottiruohonleikkuri Tukiasemamalleilla: Robomow RK1000 and RK2000, jonka jälkeen saattaa lukea "Pro", sarjanumerolla, joka on päivätty vuoden 2020 viikolle 46 ja siitä eteenpäin (vuosi ja viikko on merkitty tuotteen etikettiin 3-6 numerolla: RK2046...)

MTD Products AG vakuuttaa että yllä mainitut tuotteet noudattavat seuraavia EU-direktiivejä ja niiden harmonisoituja standardeja:

Directive 2006/42/EC - EN 60335-1:2012+AC:2014+A11:2014+A13:2017+A1:2019+A2:2019+A14:2019,

EN 50636-2-107:2015+A1:2018+A2:2020.

Directive 2014/53/EU - EN 303 447 V1.2.0 (draft), EN 300 328 V2.2.2,

EN 301 511 V12.5.1, EN 62311:2008, and

Mentioned in 2014/30/EU - EN 55014-1:2017,

EN 55014-2:2015,

EN 61000-3-2:2014,

EN 61000-3-3:2013,

EN 301489-1 V2.2.3,

EN 301489-3 V2.1.1,

EN 301489-17 V3.2.4,

EN 301489-52 V1.1.0.

Directive 2000/14/EC.

Directive 2011/65/EU.

Directive 2012/19/EU.

Tuotteet ovat kehitelty seuraavien standardien vaatimusten mukaisesti:

IEC 60335-1:2016 (versio 5.2), IEC 60335-2-107:2017 (versio 2.0)

Ilmoitetun Laitoksen, TÜV Rheinland LGA (sertifikaatin numero RT 60152438 0001) arvio tehtiin Direktiivin 2014/53/EU Artiklalle 3.2

Asiakirjojen valtuutettu edustaja:

Edustajan nimi Dipl. Insin. (AMK) Bernd Staudt

Jason L. Zielke

VP-tuotekehitys - EMEA

Saarbrücken, 8 Nov 2020

Jason L Zielke
signature

RED 2014/53/EU -tiedot

Nämä tuotteet käyttävät radiolähtimiä.
Katso tarkemmat tiedot alla olevasta kentästä.

Tx tyyppi	Taajuus	Maksimiteho
BLE	2402 – 2480 MHz	< 6 mW
GSM EGSM900	880.2 – 914.8 MHz	< 2,29 W
GSM DSC1800	1710.2 – 1784.8 MHz	< 1,38 W
SRD	3 – 8kHz	<73.2 dBuA/m 10m etäisyydellä

Vaihto-osat

Osan numero	Osan kuvaus
725-14826	Akku mallille RK1000
725-14827	Akku mallille RK2000
122-100-619	Teräsarja
742-05538	Yksi terä
725-12966	Virtalähde mallille RK1000 EU
725-12565	Virtalähde mallille RK2000 EU

FI

Vedlikehold og rengjøring



Sikkerhet først

1. Slå av roboten
2. Fjern deaktiveringsenheten før utførelse av hvilken som helst vedlikehold

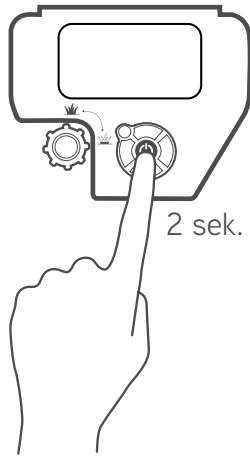

NO

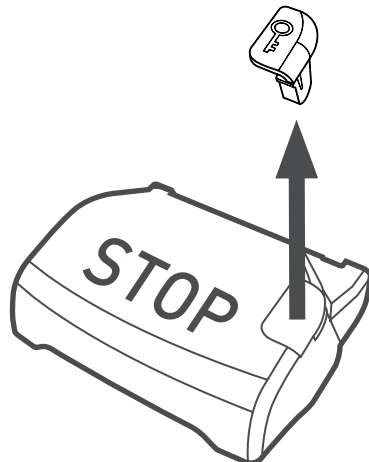
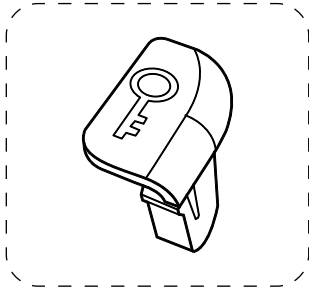

Knivbytte

Inspiser knivene med jevne mellomrom og bytt dem ut hvis de er skadet. Det anbefales å bytte ut knivene i henhold til tabellen nedenfor. Bytt alltid ut alle 4 kniver, inkludert skruene



< 500 m ²	Etter 8 - 10 uker
500 m ² - 1000 m ²	Etter 6 - 8 uker
> 1000 m ²	Etter 4 - 6 uker

Se videoen



NO

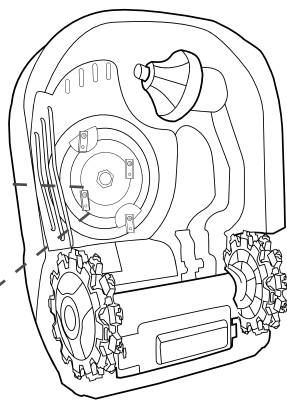
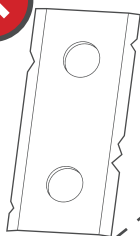
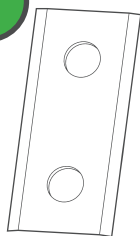

Rengjøring

RK hjul og dekk er selvrensende. Akkumulert gress, jord og rusk vil spre seg når tørre forhold kommer tilbake.

Rengjør under roboten etter hver 1-2 uker.

NO

Fjern rusk fra
hjulene

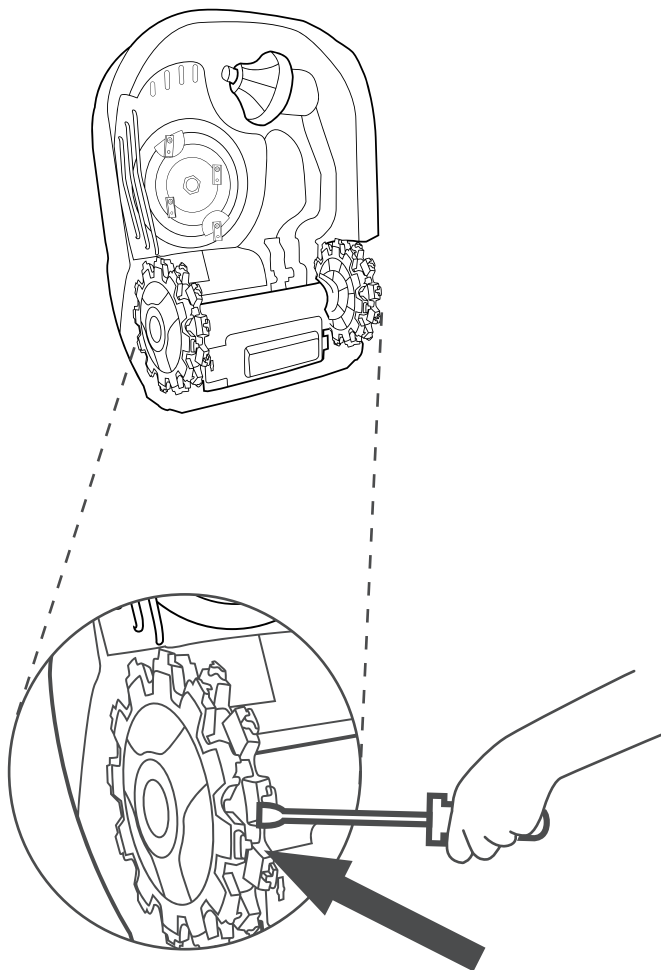

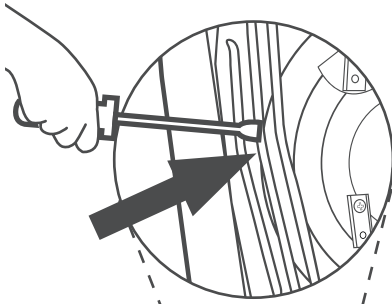

Fjern rusk mellom beskyttelsesledningene

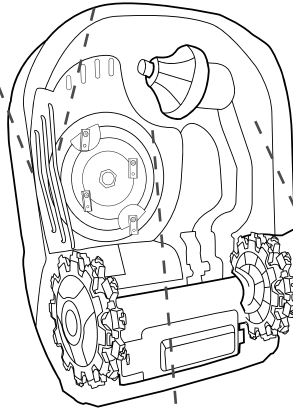

Bruk en myk børste for å fjerne rusk fra klippeaggregatet

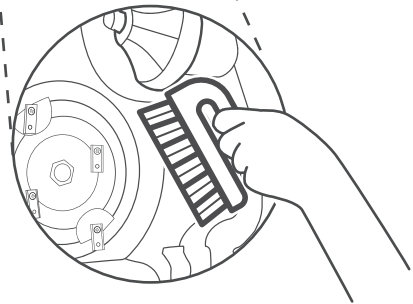

NO

Installerer hjulrensere

I lange perioder med våte forhold kan gjørme og strølag akkumulere seg på hjul. Det anbefales å feste hjulrensere for å hjelpe til med fjerning av rusk under disse forholdene.

Se videoen

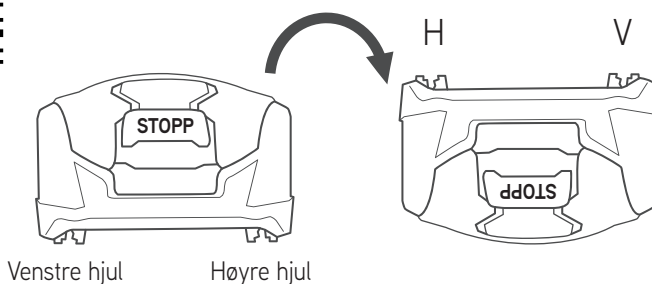

NO

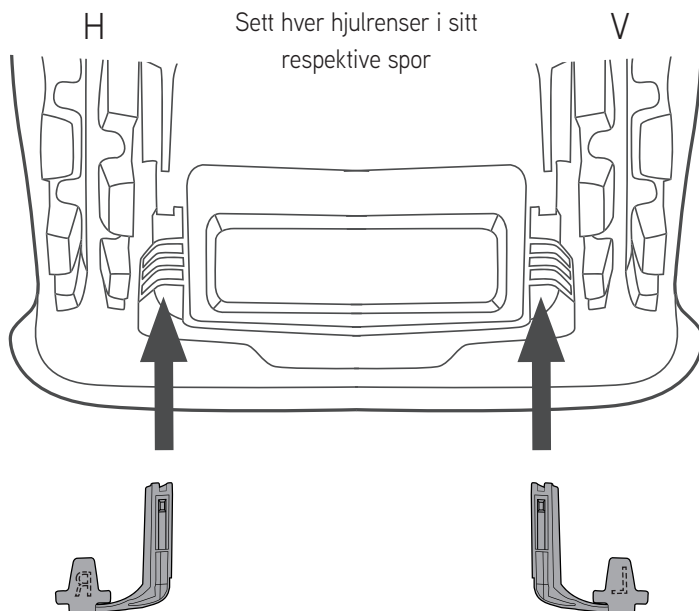

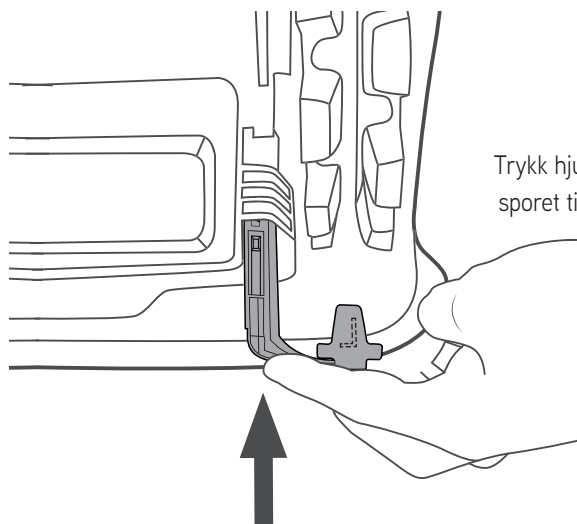

Trykk hjulrenseren godt inn i sporet til den sitter på plass

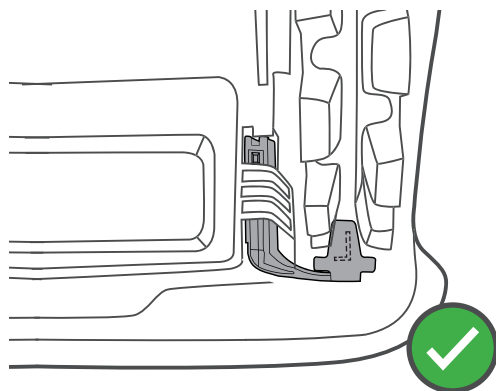

NO

Teknisk spesifikasjon	RK2000	RK1000
Modellnummer	22AKHAFB619	22AKFAFB619
Anbefalt plenstørrelse [m ²]	Opptil 2000 m ²	Opptil 1000 m ²
Klippebredde [cm]	21	21
Klippehøyde [mm]	20-100	20-100
Under-områder/startpunkter	4	4
Separerte områder	2	2
Ledning [m]	300	225
Antall plugger	400	300
Klippemotorer	DC børsteløs	DC børsteløs
Drivmotorer	DC børsteløs	DC børsteløs
Maks. helling på klippeområde	45% (24°)	45% (24°)
Maks. helling av ledningen på skråningen	20%	20%
Lydtrykknivå L _{pa} dB(A) (K=3)	50	50
Målt lydeffektnivå L _{wa} , dB(A)	61	61
Garantert lydeffektnivå L _{wa} , dB(A)	64	64
Klippetid [min]	100-120	50-60
Ladetid [min]	60-120	60-120
Batteritype	Li-Ion	Li-Ion
Spesifisert batterikapasitet [Ah]	4.9	2.8
Strømforbruk [kWh/måned]	5.1	2.8
Tyverisikring	✓	✓
Bluetooth (BLE)	✓	✓
GSM-modul	✗	✗
Følger kanttråd (MBLE/IR)	✓	✓
Maks. høyde	3,000m	3,000m
Garanti	3 år	3 år

NO

Teknisk spesifikasjon	RK2000 Pro	RK1000 Pro
Modellnummer	22AKHFA619	22AKFAFA619
Anbefalt plenstørrelse [m ²]	Opptil 2000 m ²	Opptil 1000 m ²
Klippebredde [cm]	21	21
Klippehøyde [mm]	20-100	20-100
Under-områder/startpunkter	4	4
Separerte områder	2	2
Ledning [m]	×	×
Antall plugger	×	×
Klippemotorer	DC børsteløs	DC børsteløs
Drivmotorer	DC børsteløs	DC børsteløs
Maks. helling på klippeområde	45% (24°)	45% (24°)
Maks. helling av ledningen på skråningen	20% (11°)	20% (11°)
Lydtryknivå Lpa dB(A) (K=3)	50	50
Målt lydeffektnivå Lwa, dB(A)	61	61
Garantert lydeffektnivå Lwa, dB(A)	64	64
Klippetid [min]	100-120	50-60
Ladetid [min]	60-120	60-120
Batteritype	18,15V Li-Ion	18,15V Li-Ion
Spesifisert batterikapasitet [Ah]	4.9	2.8
Strømforbruk [kWh/måned]	5.1	2.8
Tyverisikring	✓	✓
Bluetooth (BLE)	✓	✓
GSM-modul	✓	✓
Følger kanttråd (MBLE/IR)	✓	✓
Maks. høyde	3,000m	3,000m
Garanti	3 år	3 år

NO

EU samsvarserklæring

Produkter som dekkes av denne erklæringen

18 volts batteridrevet robotgressklipper med ladestasjon, modeller: Robomow RK1000 and RK2000, kan være etterfulgt av «Pro» med serienummer fra år 2020, uke 46 og senere (år og uke vises på produktetiketten fra siffer tre til seks: RK2046 ...)

MTD Products AG erklærer at produktet fastsatt over følger EU-direktivene og deres harmoniserte standarder:

Directive 2006/42/EC - EN 60335-1:2012+AC:2014+A11:2014+A13:2017+A1:2019+A2:2019+A14:2019,

EN 50636-2-107:2015+A1:2018+A2:2020.

Directive 2014/53/EU - EN 303 447 V1.2.0 (draft), EN 300 328 V2.2.2,

EN 301 511 V12.5.1, EN 62311:2008, and

Mentioned in 2014/30/EU - EN 55014-1:2017,

EN 55014-2:2015,

EN 61000-3-2:2014,

EN 61000-3-3:2013,

EN 301489-1 V2.2.3,

EN 301489-3 V2.1.1,

EN 301489-17 V3.2.4,

EN 301489-52 V1.1.0.

Directive 2000/14/EC.

Directive 2011/65/EU.

Directive 2012/19/EU.

Produktene er utviklet i samsvar med følgende standarder:

IEC 60335-1:2016 (utgave 5.2), IEC 60335-2-107:2017 (utgave 2.0)

Teknisk kontroll ble utført av TUV Rheinland LGA (sertifikatnummer RT 60152438 0001) for Artikkel 3.2 i direktiv 2014/53/EU

Autorisert representant for dokumenter:

Representantens navn Dipl. Ing. (FH) Hr. Bernd Staudt

Jason L. Zielke

VP produktutvikling - EMEA

Saarbrücken, 8 Nov 2020

signature

RED 2014/53/EU info

Disse produktene inneholder radiosendere.
Spesifikasjoner finnes i tabellen under.

Tx type	Frekvens	Maks effekt
BLE	2402 – 2480 MHz	< 6 mW
GSM EGSM900	880.2 – 914.8 MHz	< 2.29 W
GSM DSC1800	1710.2 – 1784.8 MHz	< 1.38 W
SRD	3 – 8kHz	< 73.2 dBuA/m @ 10m

Reservedeler

Delenummer	Delbeskrivelse
725-14826	Batteri for RK1000
725-14827	Batteri for RK2000
122-100-619	Knivsett
742-05538	Enkel kniv
725-12966	Strømforsyning for RK1000 EU
725-12565	Strømforsyning for RK2000 EU

NO

Underhåll och rengöring



Säkerhet först

1. Stäng av roboten
2. Ta bort inaktiveringsenheten innan något underhåll utförs

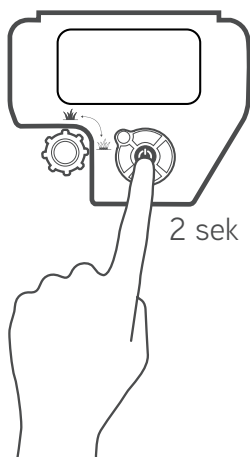

SE

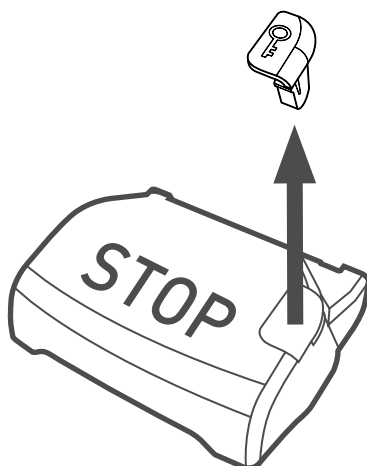
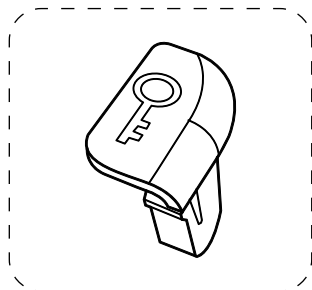

Knivbyte

Inspektera knivarna regelbundet och byt ut dem vid skada.
Det rekommenderas att byta ut knivarna enligt tabellen nedan.
Byt alltid ut alla 4 knivarna, inklusive skruvarna



< 500 m ²	Var 8:e -10:e vecka
500 m ² - 1000 m ²	Var 6:e -8:e vecka
> 1000 m ²	Var 4:e -6:e vecka

Titta på videon

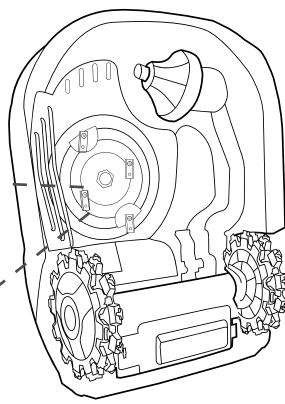
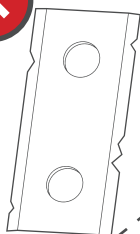
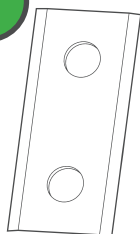

SE

Rengöring

RK-hjulen och däckets är självrengörande. Ackumulerat gräs, jord och skräp skringras när torra förhållanden återkommer.

Rengör robotens undersida varje 1-2 veckor.

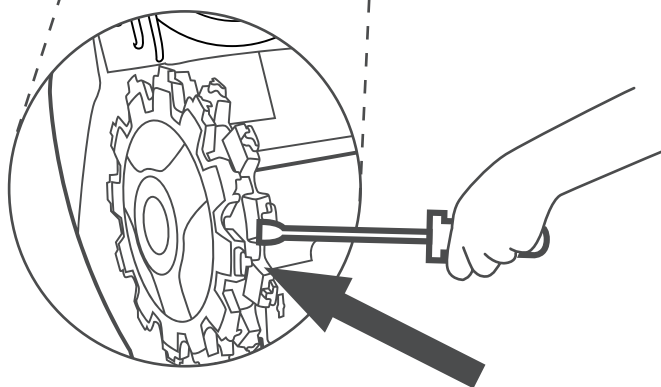
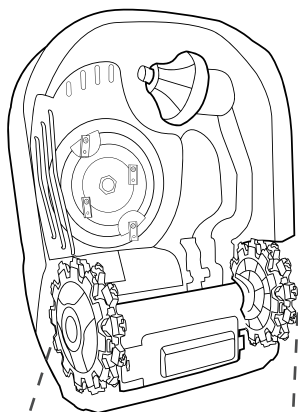

Ta bort skräp från
hjulen

SE

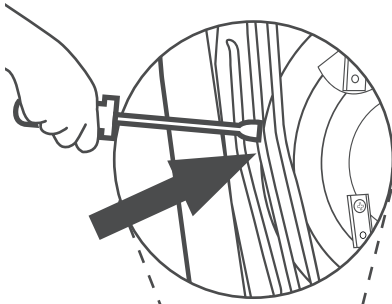

Ta bort skräp mellan
skyddskablarna

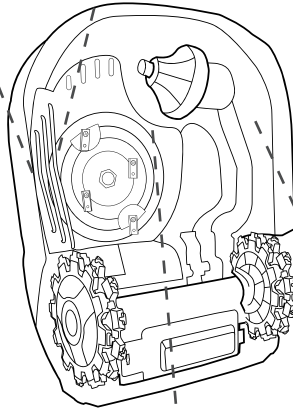

Använd en mjuk borste
för att ta bort skräp från
gräsklipparhöljet

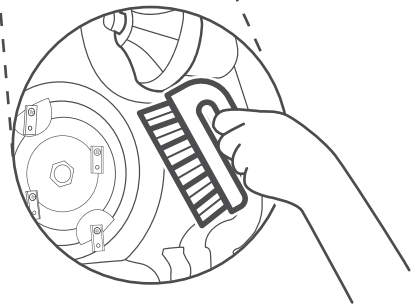

SE

Installera hjulrensarna

Under längre perioder av ökade blötta förhållanden kan lera och kompost ansamlas på hjulen. Det rekommenderas att du fästa hjulrengöringstillbehöret för att hjälpa till vid borttagning av skräp under dessa förhållanden.

Titta på videon

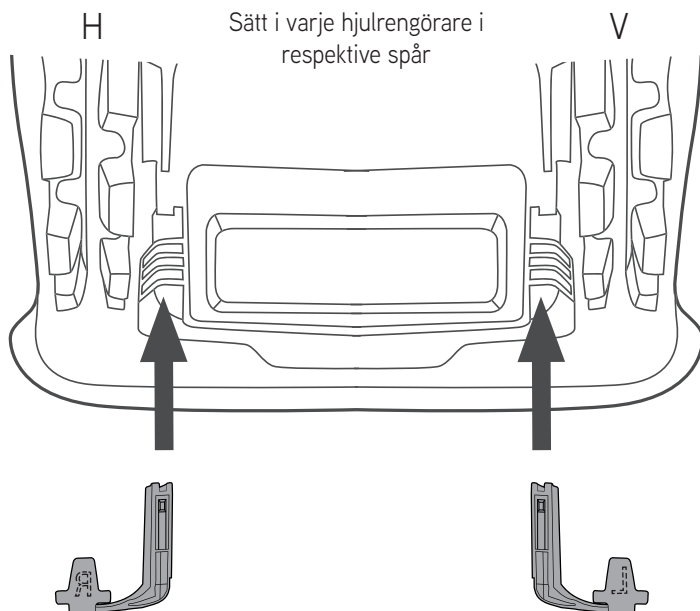
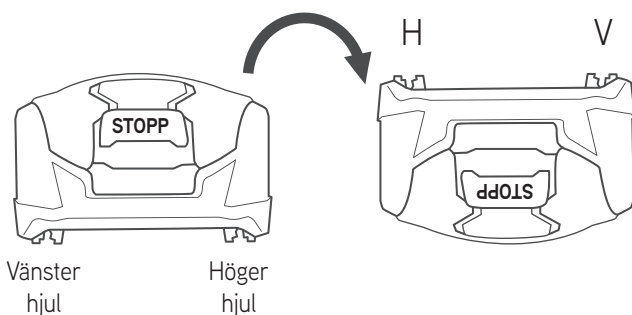

SE

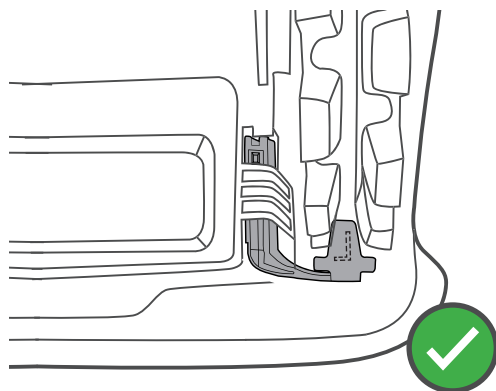
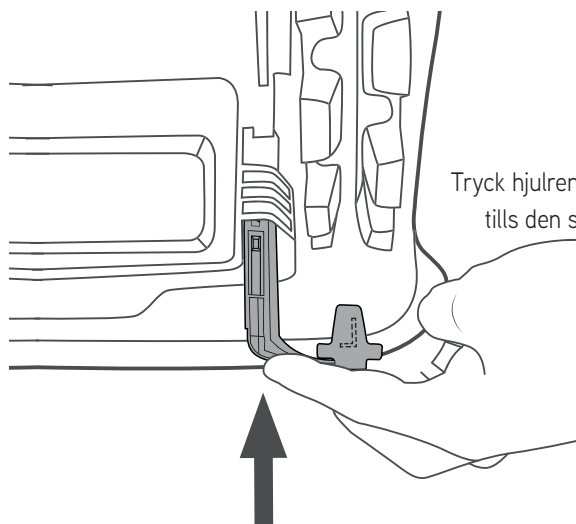

SE

Teknisk specifikation	RK2000	RK1000
Modellnummer	22AKHAFB619	22AKFAFB619
Rekommenderad storlek på gräsmattan [m ²]	Upp till 2000 m ²	Upp till 1000 m ²
Klippbredd [cm]	21	21
Klipphöjd height [mm]	20-100	20-100
Delzoner/startpunkter	4	4
Separerade zoner	2	2
Kabel [m]	300	225
Antal pinnar	400	300
Klippmotorer	DC utan borste	DC utan borste
Drivmotorer	DC utan borste	DC utan borste
Klippområdets max. lutning	45% (24°)	45% (24°)
Max. kabellutning i sluttning	20%	20%
Ljudtrycksnivå L _{pa} dB(A) (K=3)	50	50
Uppmätt ljudeffektnivå, L _{wa} , dB(A)	61	61
Garanterad ljudeffektnivå, L _{wa} , dB(A)	64	64
Klipptid [min]	100-120	50-60
Laddningstid [min]	60-120	60-120
Batterityp	Lithium	Lithium
Batterikapacitet specifikation [Ah]	4.9	2.8
Strömförbrukning [kWh/month]	5.1	2.8
Stölskydd	✓	✓
Bluetooth (BLE)	✓	✓
GSM-modul	✗	✗
Kantkabelföljandet (MBLE/IR)	✓	✓
Maximal höjd	3,000m	3,000m
Garanti	3 år	3 år

SE

Teknisk specifikation	RK2000 Pro	RK1000 Pro
Modellnummer	22AKHFA619	22AKFAFA619
Rekommenderad storlek på gräsmattan [m ²]	Upp till 2000 m ²	Upp till 1000 m ²
Klippbredd [cm]	21	21
Klipphöjd	20-100	20-100
Delzoner/startpunkter	4	4
Separerade zoner	2	2
Kabel [m]	×	×
Antal pinnar	×	×
Klippmotorer	DC utan borste	DC utan borste
Drivmotorer	DC utan borste	DC utan borste
Klippområdets max. lutning	45% (24°)	45% (24°)
Max. kabellutning i sluttning	20% (11°)	20% (11°)
Ljudtrycksnivå L _{pa} dB(A) (K=3)	50	50
Uppmätt ljudeffektnivå, L _{wa} , dB(A)	61	61
Garanterad ljudeffektnivå, L _{wa} , dB(A)	64	64
Klipptid [min]	100-120	50-60
Laddningstid [min]	60-120	60-120
Batterityp	18,15V Li-Ion	18,15V Li-Ion
Batterikapacitet specifikation [Ah]	4.9	2.8
Strömförbrukning [kWh/månad]	5.1	2.8
Stölskydd	✓	✓
Bluetooth (BLE)	✓	✓
GSM-modul	✓	✓
Kantkabelföljandet (MBLE/IR)	✓	✓
Maximal höjd	3,000m	3,000m
Garanti	3 år	3 år

SE

EU-försäkran om överensstämmelse

De produkter som omfattas av denna överensstämmelse

18-volts batteridrivna robotgräsklippare med basstationsmodeller: Robomow RK1000 och RK2000, kan följas av "Pro", med serienummer från 2020 års vecka 46 och framåt (Året och veckan anges på produktskylten i siffrorna tre till sex: RK2046 ...)

MTD Produkter AG försäkrar att produkterna identifierade ovan överensstämmer med följande EU-direktiv:

Directive 2006/42/EC - EN 60335-1:2012+AC:2014+A11:2014+A13:2017+A1:2019+A2:2019+A14:2019,

EN 50636-2-107:2015+A1:2018+A2:2020.

Directive 2014/53/EU - EN 303 447 V1.2.0 (draft), EN 300 328 V2.2.2,

EN 301 511 V12.5.1, EN 62311:2008, and

Mentioned in 2014/30/EU - EN 55014-1:2017,

EN 55014-2:2015,

EN 61000-3-2:2014,

EN 61000-3-3:2013,

EN 301489-1 V2.2.3,

EN 301489-3 V2.1.1,

EN 301489-17 V3.2.4,

EN 301489-52 V1.1.0.

SE

Directive 2000/14/EC.

Directive 2011/65/EU.

Directive 2012/19/EU.

Produkterna har utvecklats i överensstämmelse med följande standarder:

IEC 60335-1: 2016 (utgåva 5.2), IEC 60335-2-107: 2017 (utgåva 2.0)

Bedömning av anmänt organ genom TUV Rheinland LGA (certifikatnummer RT 60152438 0001) gjordes för artikel 3.2 i direktiv 2014/53 / EU

Auktoriserad representant för dokumenten:

Representantens namn Dipl. Ing. (FH) Bernd Staudt

Jason L. Zielke

VP Produktutveckling - EMEA

Saarbrücken, 8 Nov 2020

Jason L Zielke
signature

RED 2014/53/EU info

Dessa produkter använder radiosändare.
Detaljer i tabellen nedan.

Sändartyp	Frekvens	Maxeffekt
BLE	2402 – 2480 MHz	< 6 mW
GSM EGSM900	880.2 – 914.8 MHz	< 2.29 W
GSM DSC1800	1710.2 – 1784.8 MHz	< 1.38 W
SRD	3 – 8kHz	<73.2 dBuA/m @ 10m

Reservdelar

Delnummer	Artikelbeskrivning
725-14826	Batteri till RK1000
725-14827	Batteri till RK2000
122-100-619	Knivset
742-05538	Enkelkniv
725-12966	Strömförsörjning för RK1000 EU
725-12565	Strömförsörjning för RK2000 EU

SE

Mantenimiento y limpieza



Seguridad ante todo

1. Apagar el robot
2. Antes de cualquier tarea de mantenimiento, quitar el dispositivo de desactivación



ES

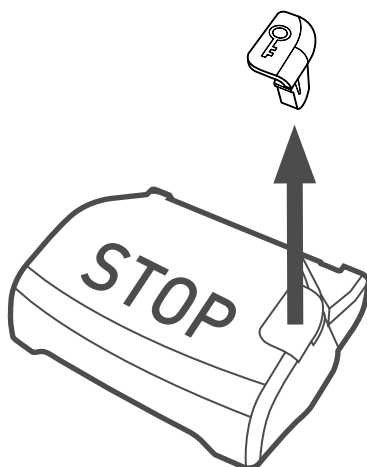
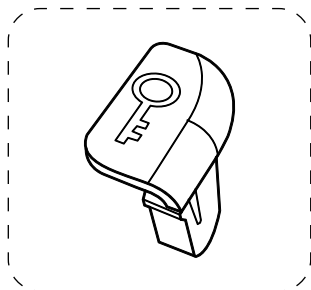

Reemplazo de cuchillas

Inspeccionar periódicamente las cuchillas y, si están dañadas, cambiarlas. Se recomienda cambiar las cuchillas conforme a la tabla siguiente. Cambiar siempre las 4 cuchillas con sus respectivos tornillos



500 m ²	Cada 8 o 10 semanas
500 m ² - 1000 m ²	Cada 6 u 8 semanas
> 1000 m ²	Cada 4 o 6 semanas

Ver el vídeo

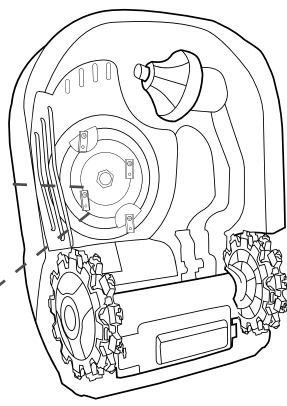
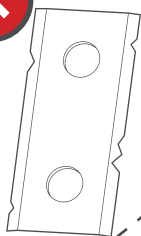
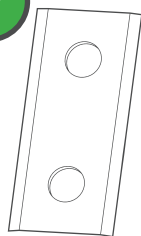

ES

Limpeza

Las ruedas y la plataforma del modelo RK son autolimpiables. La hierba, la tierra y los residuos acumulados se dispersarán al al reanudarse el tiempo seco.

Cada una o dos semanas, limpiar el robot por debajo.

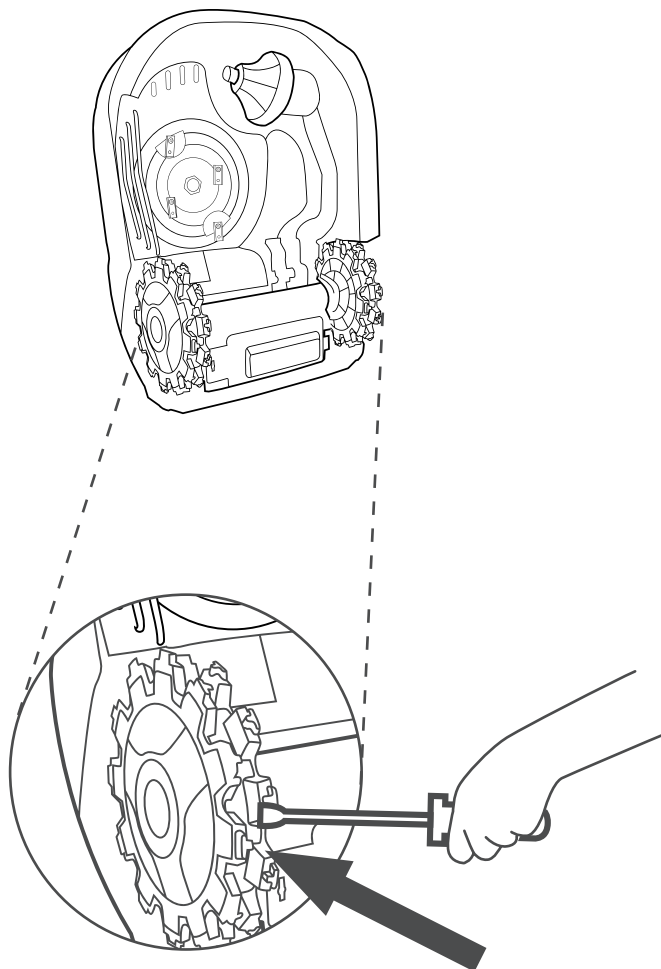

Quitar los residuos
de las ruedas

ES

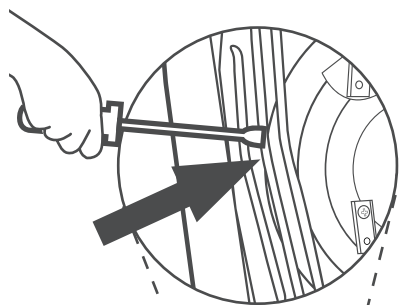

Quite los residuos
entre los cables de
protección

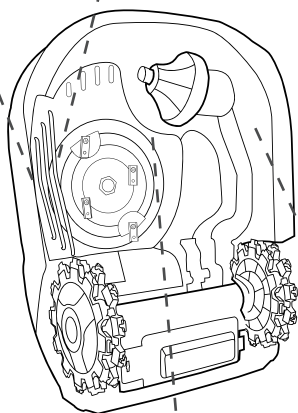

Para quitar los residuos de
la plataforma de corte, utilice
un cepillo suave

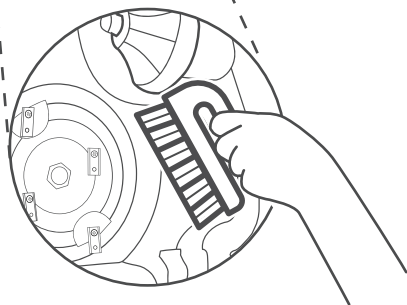

ES

Instalar los limpiadores de ruedas

Durante períodos prolongados de humedad podría acumularse lodo y mantillo en las ruedas. Para facilitar la limpieza de residuos en estas condiciones, se recomienda instalar los limpiadores de ruedas.

Ver el vídeo

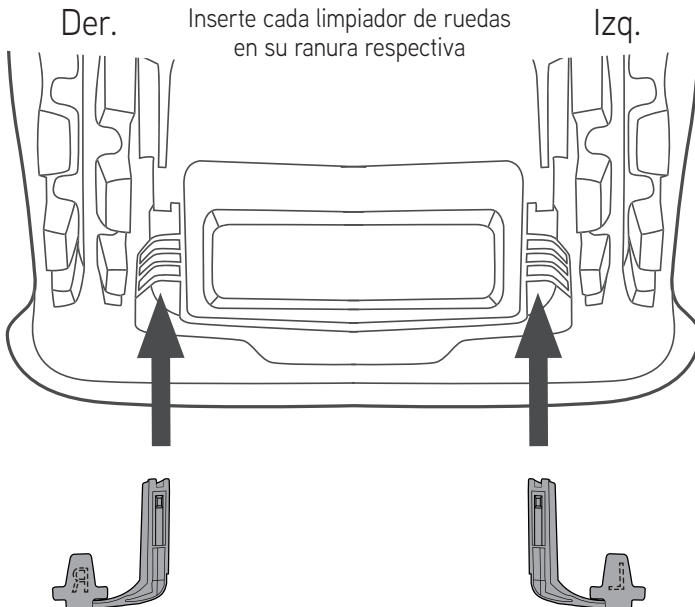
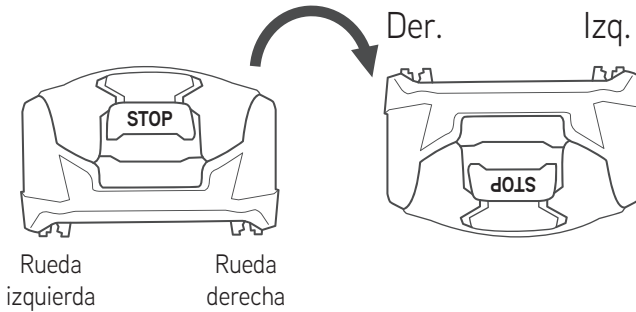

ES

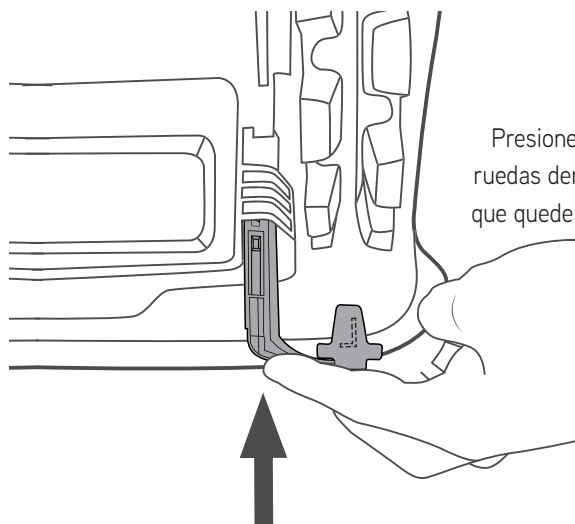

Presione bien el limpiador de
ruedas dentro de la ranura hasta
que quede bien firme en su lugar

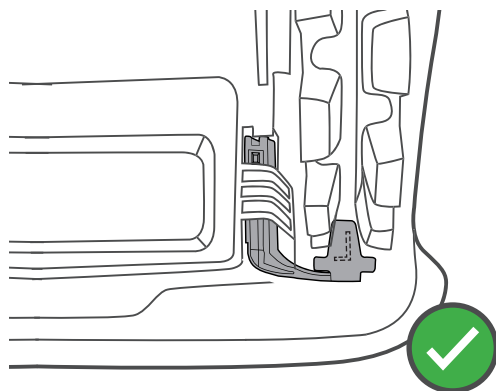

ES

Especificaciones técnicas	RK2000	RK1000
Número de modelo	22AKHAFB619	22AKFAFB619
Tamaño de césped recomendado [en m ²]	Hasta 2000 m ²	Hasta 1000 m ²
Anchura de corte [en cm]	21	21
Altura de corte [en mm]	20-100	20-100
Subzonas/puntos de partida	4	4
Zonas separadas	2	2
Cable [m]	300	225
Cantidad de estacas	400	300
Motores de corte	CC sin escobillas	CC sin escobillas
Motores de accionamiento	CC sin escobillas	CC sin escobillas
Inclinación máx. del área de corte	45% (24°)	45% (24°)
Inclinación máx. del cable en pendiente	20%	20%
Sound pressure level L _{pa} dB(A) (K=3)	50	50
Measured sound power level L _{wa} , dB(A)	61	61
Guaranteed sound power level L _{wa} , dB(A)	64	64
Tiempo de corte [en min]	100-120	50-60
Tiempo de carga [en min]	60-120	60-120
Tipo de batería	Litio-ion	Litio-ion
Capacidad específica de batería [Ah]	4,9	2,8
Consumo de energía [kWh/mes]	5,1	2,8
Antirrobo	✓	✓
Bluetooth (BLE)	✓	✓
Módulo GSM	✗	✗
Seguimiento cercano de cable (MBLE/IR)	✓	✓
Altitud máxima	3000 m	3000 m
Garantía	3 años	3 años

Especificaciones técnicas	RK2000 Pro	RK1000 Pro
Número de modelo	22AKHAF619	22AKFAFA619
Tamaño de césped recomendado [en m ²]	Hasta 2000 m ²	Hasta 1000 m ²
Anchura de corte [en cm]	21	21
Altura de corte [en mm]	20-100	20-100
Subzonas/puntos de partida	4	4
Zonas separadas	2	2
Cable [m]	×	×
Cantidad de estacas	×	×
Motores de corte	CC sin escobillas	CC sin escobillas
Motores de accionamiento	CC sin escobillas	CC sin escobillas
Inclinación máx. del área de corte	45% (24°)	45% (24°)
Inclinación máx. del cable en pendiente	20% (11°)	20% (11°)
Sound pressure level Lpa dB(A) (K=3)	50	50
Measured sound power level Lwa, dB(A)	61	61
Guaranteed sound power level Lwa, dB(A)	64	64
Tiempo de corte [en min]	100-120	50-60
Tiempo de carga [en min]	60-120	60-120
Tipo de batería	Litio-ion de 18,15 voltios	Litio-ion de 18,15 voltios
Capacidad específica de batería [Ah]	4,9	2,8
Consumo de energía [kWh/mes]	5.1	2,8
Antirrobo	✓	✓
Bluetooth (BLE)	✓	✓
Módulo GSM	✓	✓
Seguimiento cercano de cable (MBLE/IR)	✓	✓
Altitud máxima	3000 m	3000 m
Garantía	3 años	3 años

Declaración de Conformidad para la UE

Productos regulados por esta Declaración

Modelos de cortacésped automático accionados por batería de 12 voltios con estación base: Loopo RK1000 y Loopo RK2000, podrían ir seguidos de «Pro», con un número de serie del año 2020, semana 45 en adelante (el año y la semana se indican en la etiqueta del producto, en las cifras del tres al seis: RK2045...)

MTD Products AG declara que los productos identificados anteriormente se ajustan a las siguientes directivas de la Unión Europea y sus normas armonizadas:

Directive 2006/42/EC - EN 60335-1:2012+AC:2014+A11:2014+A13:2017+A1:2019+A2:2019+A14:2019,

EN 50636-2-107:2015+A1:2018+A2:2020.

Directive 2014/53/EU - EN 303 447 V1.2.0 (draft), EN 300 328 V2.2.2,

EN 301 511 V12.5.1, EN 62311:2008, and

Mentioned in 2014/30/EU - EN 55014-1:2017,

EN 55014-2:2015,

EN 61000-3-2:2014,

EN 61000-3-3:2013,

EN 301489-1 V2.2.3,

EN 301489-3 V2.1.1,

EN 301489-17 V3.2.4,

EN 301489-52 V1.1.0.

Directive 2000/14/EC.

Directive 2011/65/EU.

Directive 2012/19/EU.

ES

Los productos se han desarrollado de conformidad con las siguientes normas:

CEI 60335-1:2016 (Edición 5.2), CEI 60335-2-107:2017 (Edición 2.0)

Evaluación de organismo notificado por TUV Rheinland LGA (número de certificado RT 60152438 0001)/0069/UK" establecido en relación con el artículo 3.2 de la Directiva 2014/53/UE

Representante autorizado para la documentación:

Nombre del representante: Ing. Diplomado (FH) Bernd Staudt

Jason L. Zielke

Vicepresidente de Desarrollo de productos en EMEA

Saarbrücken, 8 de noviembre de 2020

Jason L Zielke
signature

Información de RED 2014/53/UE

Estos productos utilizan radiotransmisores.
Las especificaciones se pueden ver en la tabla siguiente.

Tipo de transmisión	Frecuencia	Potencia máxima
BLE	2402 a 2480 MHz	< 6 mW
GSM EGSM900	880,2 a 914,8 MHz	< 2,29 vatios
GSM DSC1800	1710,2 a 1784,8 MHz	< 1,38 vatios
SRD	3 a 8 kHz	<73,2 dBuA/m a 10 m

Piezas de recambio

Número de pieza	Descripción de la pieza
725-14826	Batería para RK1000
725-14827	Batería para RK2000
122-100-619	Kit de cuchilla
742-05538	Cuchilla única
725-12966	Fuente de alimentación para RK1000 EU
725-12565	Fuente de alimentación para RK2000 EU

ištní a údržba



Bezpečnost pedevším

1. Vypněte robot.
2. Před zahájením údržby vyjměte blokovací zařízení.

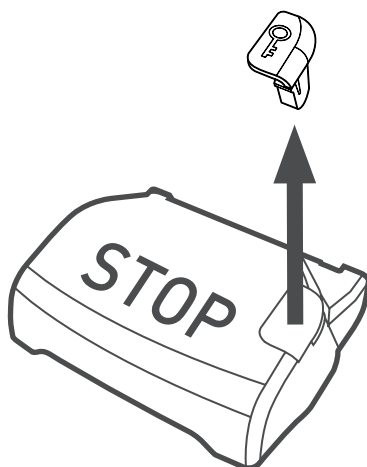
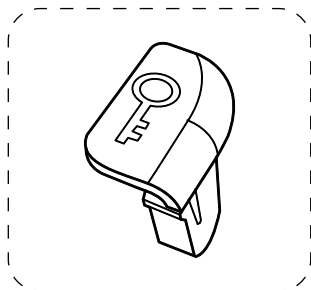
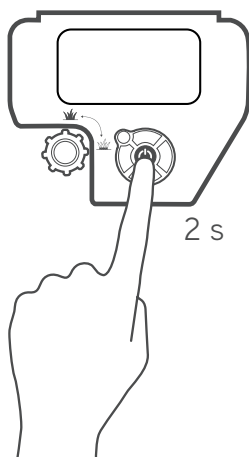

Výmna no

Nože pravidelně kontrolujte a v případě poškození je vyměňte. Doporučený interval výměny nožů je uveden v tabulce níže. Vždy vyměňte všechny 4 nože včetně šroubů.



< 500 m ²	Každých 8 až 10 týdnů
500 m ² až 1000 m ²	Každých 6 až 8 týdnů
> 1000 m ²	Každých 4 až 6 týdnů

Zhlédnout video

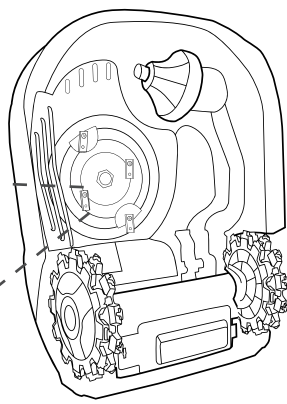
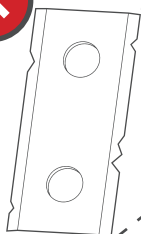
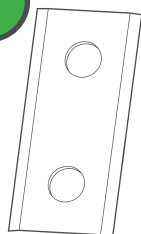

CZ

ištní

Kola a sekací sestava jsou u modelů RK samočisticí. Nahromaděná tráva, zemina a nečistoty za sucha samy vypadají. Každý 1 až 2 týdny vyčistěte spodek robotu.

Vyčistěte kola.

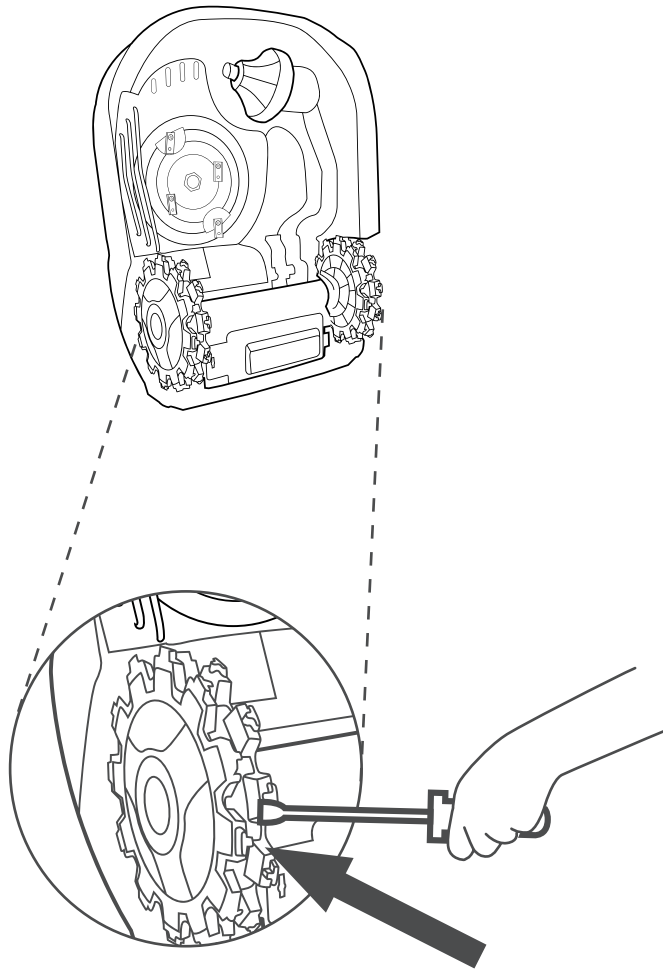

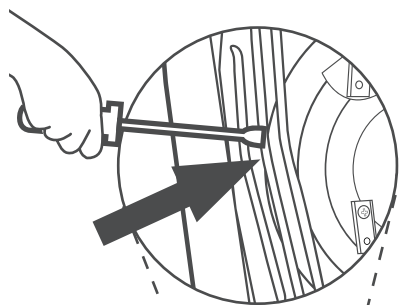

Vyčistěte prostor mezi
ochrannými dráty.

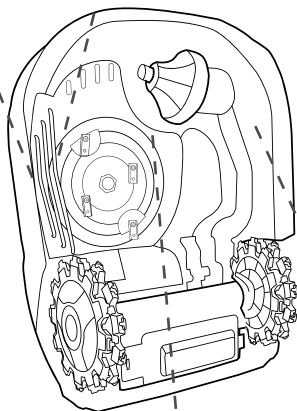

Měkkým kartáčem vyčistěte
sekací sestavu.

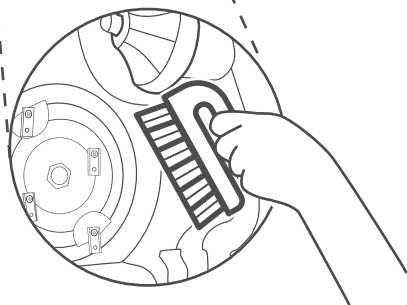

CZ

Nainstalujte zástrčky kol.

Během delších období vlhka se na kolech může nahromadit bláto nebo zbytky mulče. Za podobných podmínek se doporučuje montáž zástěrek kol, které usnadňují čištění.

Zhlédnout video

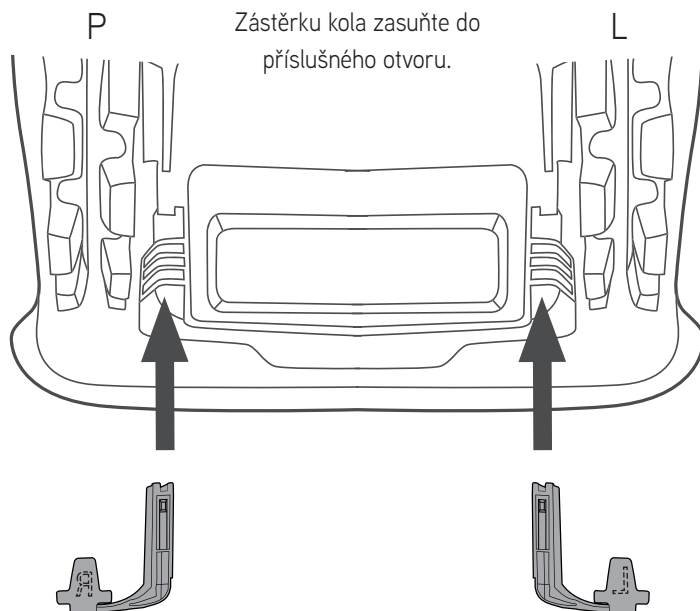
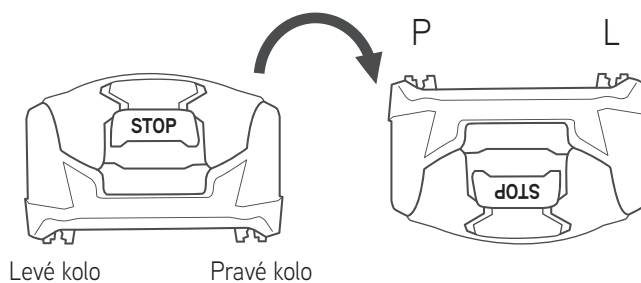

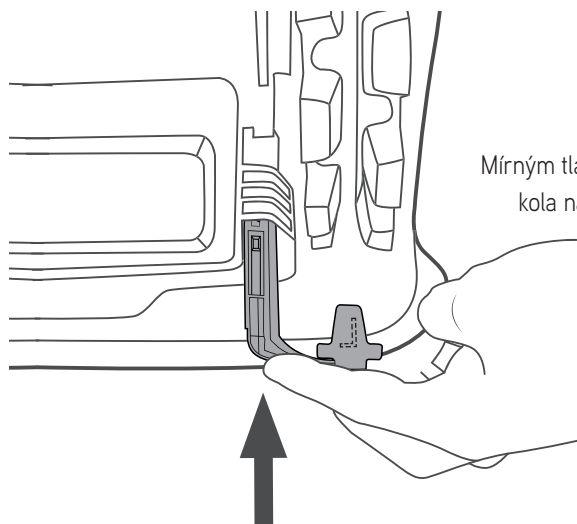

Mírným tlakem usadíte zástěrku
kola na příslušné místo.

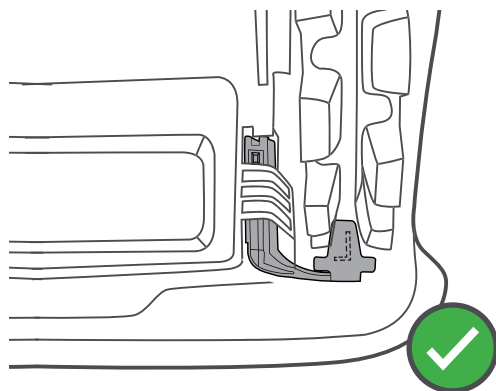

CZ

Technické specifikace	RK2000	RK1000
Číslo modelu	22AKHAFB619	22AKFAFB619
Doporučená plocha trávníku [m ²]	Do 2000 m ²	Do 1000 m ²
Šířka sečení [cm]	21	21
Výška sečení [mm]	20-100	20-100
Podzóny / počáteční body	4	4
Oddělené zóny	2	2
Drát [m]	300	225
Počet kolíků	400	300
Motory sečení	Stejnoseměrný bezkartáčový	Stejnoseměrný bezkartáčový
Motory pojezdu	Stejnoseměrný bezkartáčový	Stejnoseměrný bezkartáčový
Max. sklon sekané plochy	45% (24°)	45% (24°)
Max. sklon drátu na svahu	20%	20%
Hladina akustického tlaku L _{pa} dB(A) (K=3)	50	50
Jmenovitá hladina akustického výkonu L _{wa} , dB(A)	61	61
Garantovaná hladina akustického výkonu L _{wa} , dB(A)	64	64
Doba sečení [min]	100-120	50-60
Doba nabíjení [min]	60-120	60-120
Typ baterie	Li-Ion	Li-Ion
Jmenovitá kapacita baterie [Ah]	4,9	2,8
Spotřeba energie [kWh/měsíc]	5,1	2,8
Zabezpečení proti krádeži	✓	✓
Bluetooth (BLE)	✓	✓
Modul GSM	✗	✗
Jízda blízko drátu (MBLE/IR)	✓	✓
Maximální nadmořská výška	3 000 m	3 000 m
Záruka	3 roky	3 roky

Technické specifikace	RK2000 Pro	RK1000 Pro
Číslo modelu	22AKHAF619	22AKFAFA619
Doporučená plocha trávníku [m ²]	Do 2000 m ²	Do 1000 m ²
Šířka sečení [cm]	21	21
Výška sečení [mm]	20-100	20-100
Podzóny / počáteční body	4	4
Oddělené zóny	2	2
Drát [m]	×	×
Počet kolíků	×	×
Motory sečení	Stejnoseměrný bezkartáčový	Stejnoseměrný bezkartáčový
Motory pojezdu	Stejnoseměrný bezkartáčový	Stejnoseměrný bezkartáčový
Max. sklon sekané plochy	45% (24°)	45% (24°)
Max. sklon drátu na svahu	20% (11°)	20% (11°)
Hladina akustického tlaku L _{pa} dB(A) (K=3)	50	50
Jmenovitá hladina akustického výkonu L _{wa} , dB(A)	61	61
Garantovaná hladina akustického výkonu L _{wa} , dB(A)	64	64
Doba sečení [min]	100-120	50-60
Doba nabíjení [min]	60-120	60-120
Typ baterie	18,15 V Li-Ion	18,15 V Li-Ion
Jmenovitá kapacita baterie [Ah]	4,9	2,8
Spotřeba energie [kWh/měsíc]	5,1	2,8
Zabezpečení proti krádeži	✓	✓
Bluetooth (BLE)	✓	✓
Modul GSM	✓	✓
Jízda blízko drátu (MBLE/IR)	✓	✓
Maximální nadmořská výška	3 000 m	3 000 m
Záruka	3 roky	3 roky

EU Prohlášení o shodě

Výrobky, které pokrývá toto prohlášení

Modely robotické sekačky s 18V baterií a základní stanicí: Robomow RK1000 a RK2000, za názvem modelu může následovat označení „Pro“, s výrobním číslem datovaným od 46. týdne roku 2020 dále (rok a týden jsou uvedeny na produktovém štítku na pozicích tři až šest: RK2046...)

Společnost MTD Products AG prohlašuje, že produkty uvedené výše jsou v souladu s níže uvedenými směrnici EU a odpovídajícími harmonizovanými normami:

Směrnice 2006/42/EC - EN 60335-1:2012+AC:2014+A11:2014+A13:2017+A1:2019+A2:2019+A14:2019,

EN 50636-2-107:2015+A1:2018+A2:2020.

Směrnice 2014/53/EU - EN 303 447 V1.2.0 (návrh), EN 300 328 V2.2.2,

EN 301 511 V12.5.1, EN 62311:2008, a

zmíněné v 2014/30/EU - EN 55014-1:2017,

EN 55014-2:2015,

EN 61000-3-2:2014,

EN 61000-3-3:2013,

EN 301489-1 V2.2.3,

EN 301489-3 V2.1.1,

EN 301489-17 V3.2.4,

EN 301489-52 V1.1.0.

Směrnice 2000/14/EC.

Směrnice 2011/65/EU.

Směrnice 2012/19/EU.

Produkty byly vyvinuty v souladu s následujícími normami:

IEC 60335-1:2016 (vydání 5.2), IEC 60335-2-107:2017 (vydání 2.0)

Hodnocení notifikovanou osobou provedla TUV Rheinland LGA (číslo certifikátu RT 60152438 0001) pro účely článku 3.2 Směrnice 2014/53/EU.

Autorizovaný zástupce za dokumenty:

Jméno zástupce Dipl. Ing. (FH) Bernd Staudt

Jason L. Zielke

VP Product Development - EMEA

Saarbrücken, 8 Nov 2020

Jason L Zielke
signature

Směrnice RED

2014/53/EU – informace

Tyto výrobky využívají rádiové vysílače.
Specifikace jsou uvedeny v tabulce níže.

Typ vysílače	Frekvence	Max. výkon
BLE	2402 – 2480 MHz	< 6 mW
GSM EGSM900	880,2 – 914,8 MHz	< 2,29 W
GSM DSC1800	1710,2 – 1784,8 MHz	< 1,38 W
SRD	3 – 8 kHz	< 73,2 dBuA/m v 10 m

Náhradní díly

Číslo dílu	Popis dílu
725-14826	Baterie pro modely RK1000
725-14827	Baterie pro modely RK2000
122-100-619	Sestava nožů
742-05538	Samostatný nůž
725-12966	Napájení pro modely RK1000 EU
725-12565	Napájení pro modely RK2000 EU

