

Product identification

Adeo Ref	839825		
Product EAN	3276000701187		
Supplier ref	B6135		

Explosion Drawing

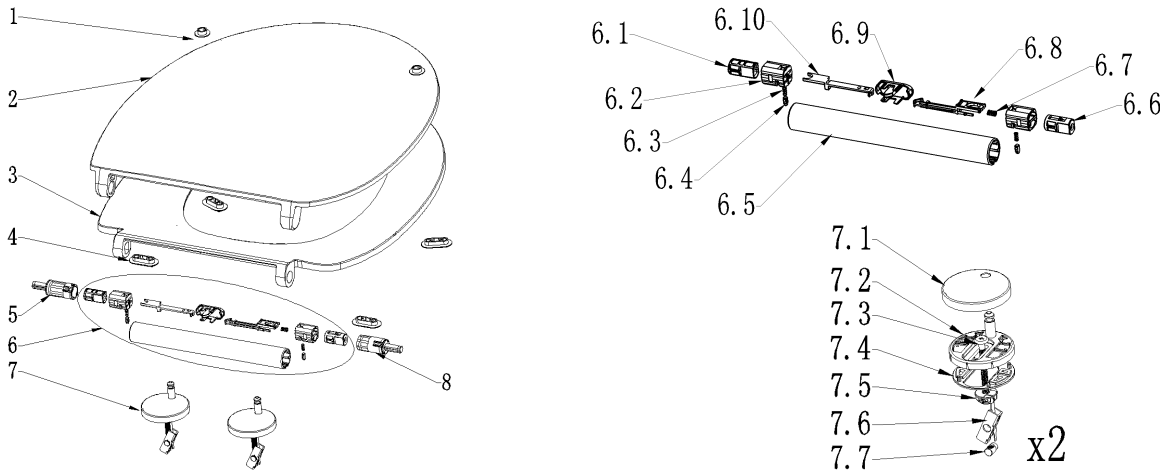

Parts No.	Quantity	Specification	Material & Surface Process
1	2	Φ 18*7.3	TPE(95°)
2	1	440*368*39	UF, Glossy white
3	1	440*368*50	UF, Glossy white
4	4	36*18*8.7	TPE(95°)
5	1	Φ 17.9*53.8	
6.1	1	Φ 14*24.6	POM
6.2	2	Φ 20*22.3	PBT
6.3	2	Φ 3.3*7.3	SUS304
6.4	2	Φ 4*8	POM
6.5	1	Φ 24*199.4	PP
6.6	1	Φ 14*24.6	POM
6.7	1	Φ 4.4*7.7	SUS304
6.8	1	66.3*14.3*9.3	POM
6.9	1	33.8*15*15.8	ABS, Chrome
6.10	1	68.4*12.9*7	POM
7.1	2	Φ 55.6*7.5	SUS304,Brushed surface
7.2	2	Φ 54*29	PP+30GF+SUS304 insert
7.3	2	M5*55.5	SUS304
7.4	2	Φ 51.2*5.8	PVC55
7.5	2	Φ 18.5*45	PA6
7.6	2	32*7.8*10.1	SUS304
7.7	2	Φ 7*11	Brass
8	1	Φ 17.9*53.8	