









# VUE ECLATEE LAVE-MAINS

Piece No.	Quantité	Désignation
1	1	Flanc gauche
2	1	Traverse
3	1	Traverse
4	1	Flanc droit
5	1	Dessous
6	1	Traverse avant haute
7	1	Traverse arrière haute
8	1	Porte
9	1	Traverse arrière basse
10	1	Fond
11	1	Etagère
12	1	Traverse avant basse
13	1	Etagère
14	1	Plan vasque

H03  20	H04  20	H82  2	S02  12
H05  8	H09  12	H07  2	H101  2
H52  4	H53  2		

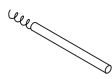

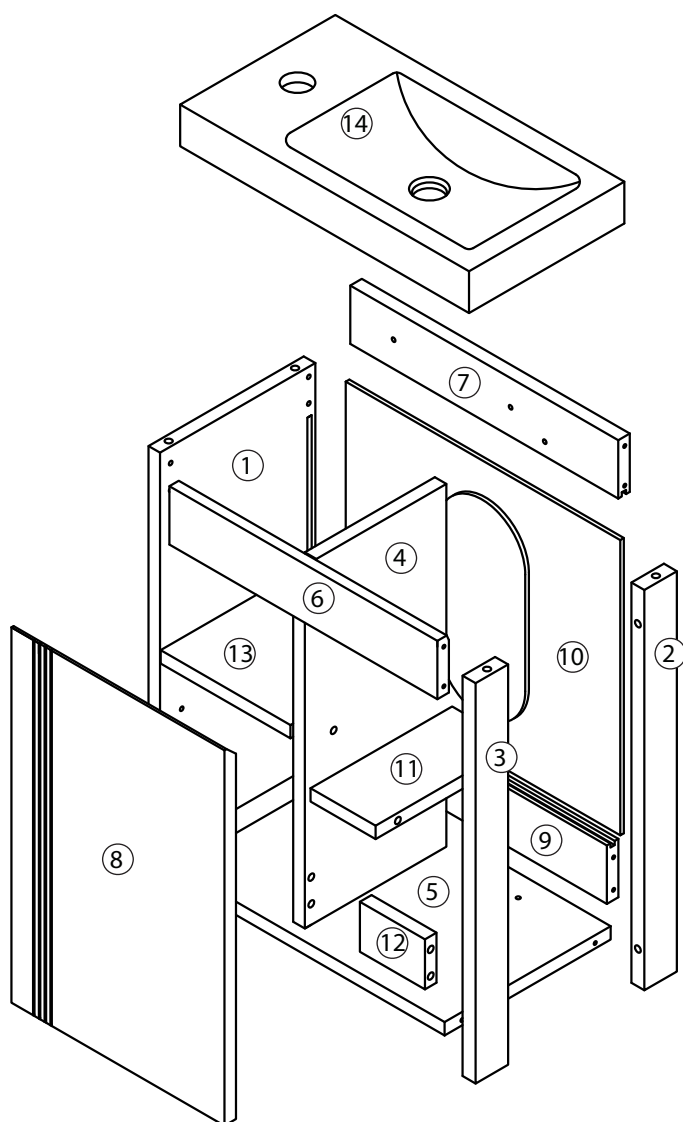
**FLYNN  
LAVE-MAINS  
MTC 1186 & 1187 & 1221 & 1222**