

Code article	Désignation	EAN	Code client LM
P/EN4/8/10M	Moustikit enroulable H100XL80 marron	3391920060517	66454311

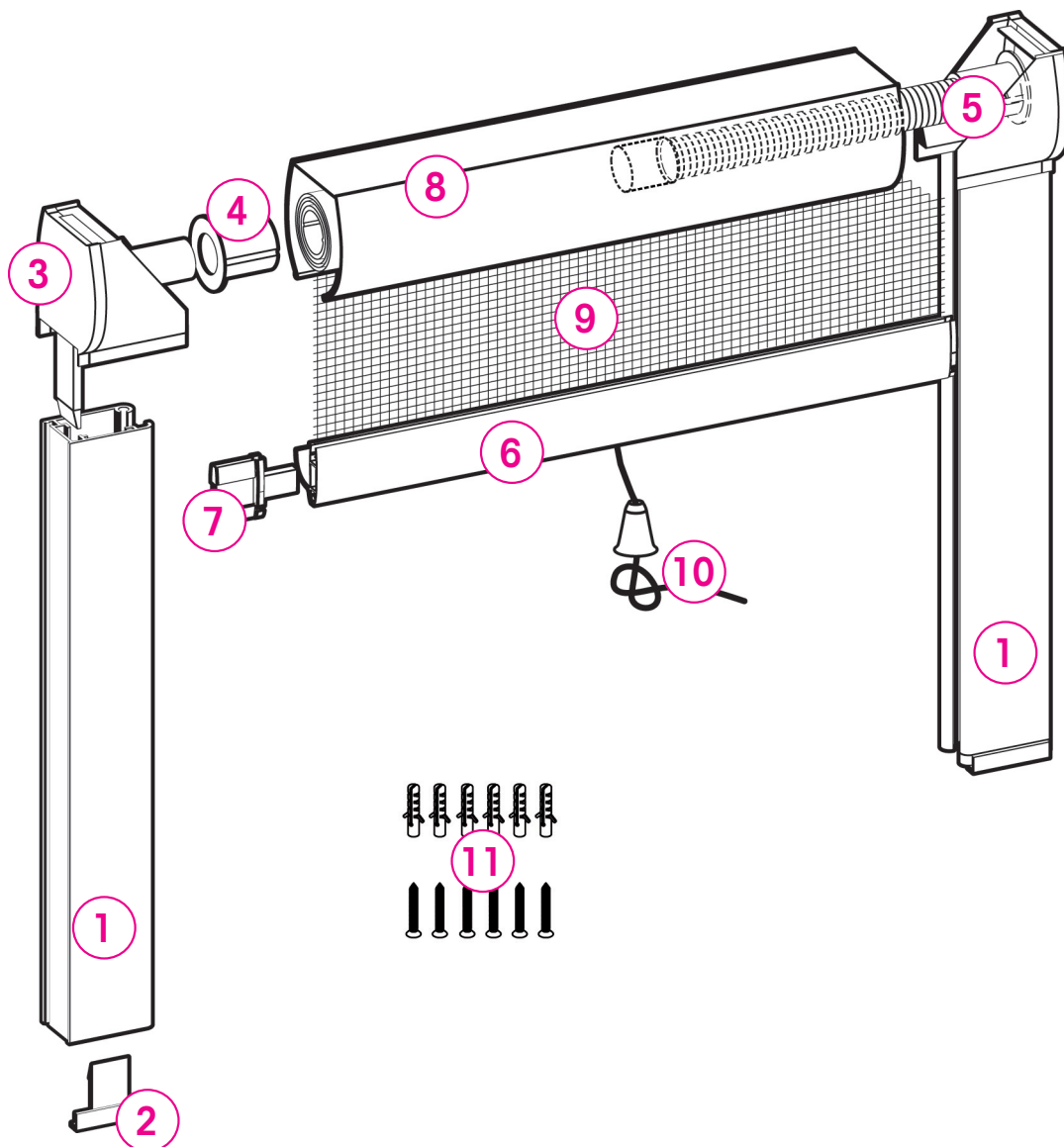

N°	Référence	Quantité	Désignation
1	C5/GLISEN2/958	2	GLISSIÈRE + FRANGE MARRON
2	E5/EMBGLIS	2	EMBOUT DE GLISSIÈRES MARRON
3	E5/ECKITB	1	EMBOUT COFFRET KIT BOITES MARRON
4	E5/BAGUE	1	BAGUE MARRON
5	G5/RES300KIT	1	RESSORT + EMBOUT COFFRET + BAGUE + EMBOUT RESSORT MARRON
6	C5/BFEN730	1	BARRE FINALE + BROSSE MARRON
7	E5/EMBBFALU	2	EMBOUT BARRE FINAL ALU MARRON
8	C5/COFEN4/780-1MM	1	COFFRE ENR ALU 780MM MARRON
9	P/TOILEMK	1	TOILE VERTICALE
10	E5/CLOCHE + E9/CORD500	1	CLOCHETTE + CORDELETTE MARRON
11	G0/SACHMKALU	1	SACHET DE VISSERIES MK ALU 04 (6 VIS + 6 CHEVILLES)