

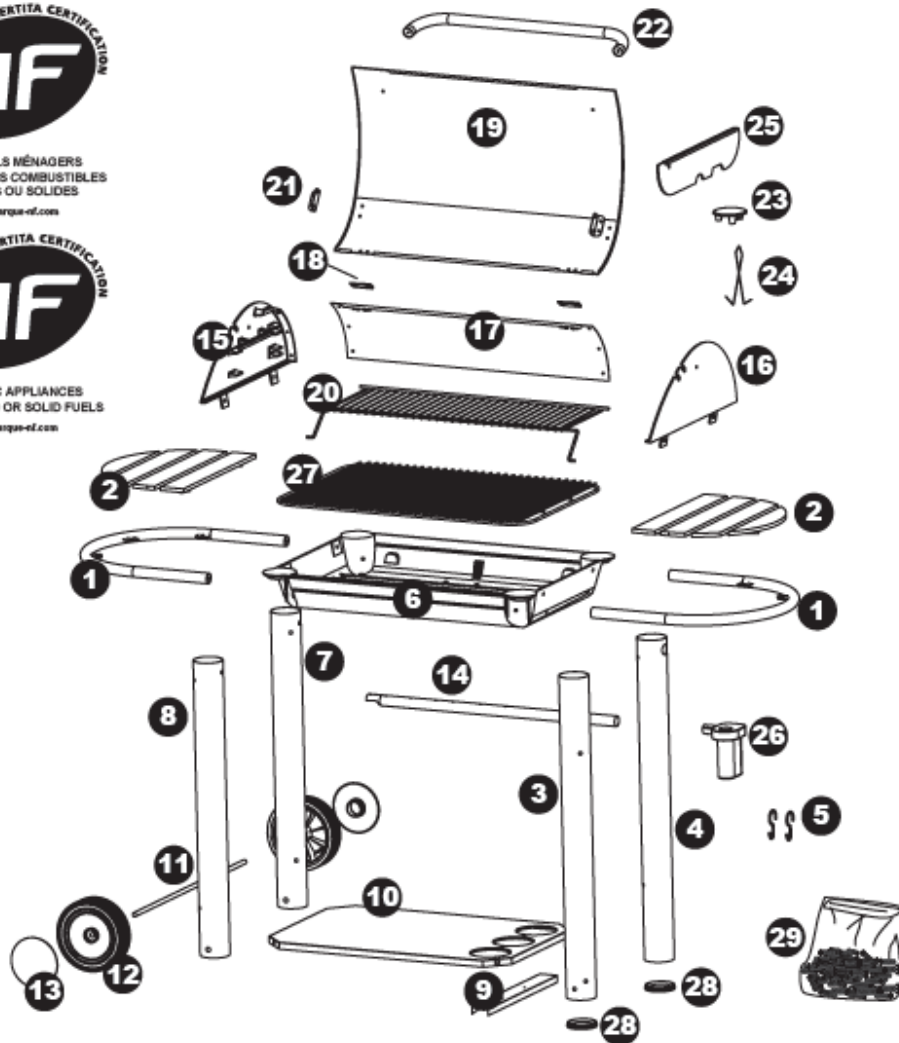









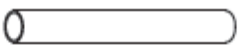



APPAREILS MÉNAGERS
UTILISANT DES COMBUSTIBLES
LIQUIDES OU SOLIDES
www.marque-nf.com



DOMESTIC APPLIANCES
USING LIQUID OR SOLID FUELS
www.marque-nf.com



	Ø8 x 55	2
	Ø6 x 90	4
	Ø6 x 80	4
	Ø6 x 65	2
	Ø6 x 45	1
	Ø6 x 20	11
	Ø4 x 12	18

	Ø4.8 x 9.5	4
	Ø4	12
	Ø6	2
	Ø10	2
	Ø6	16
	Ø4	18