

**BARBECUES :  
PLANCHA BF LXD TWIN**

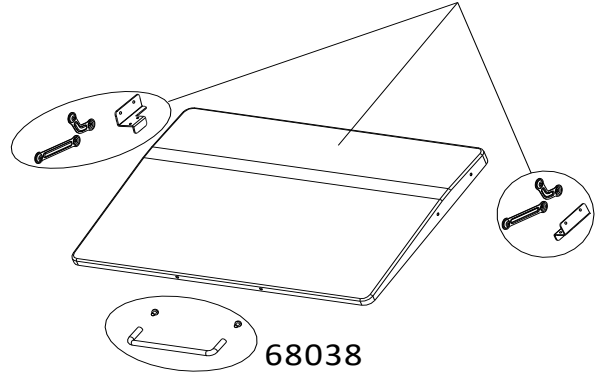

# BARBECUES : PLANCHA BF LXD TWIN

5010006158



5010006159

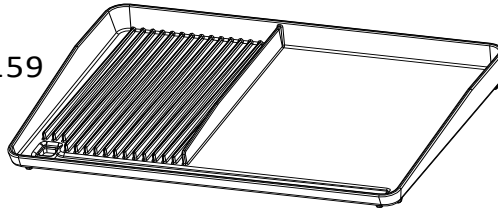

5010004742

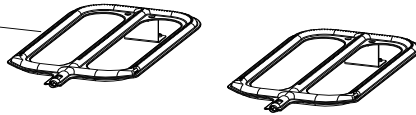

5010004769 (28 Mb)

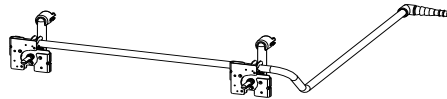
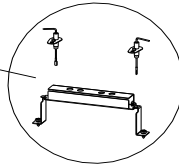

5010005597

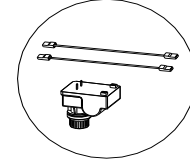

5010004743

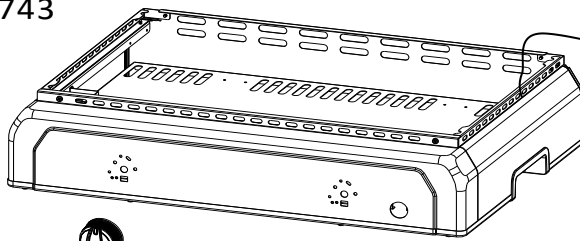

5010006150



5010005834



5010006155

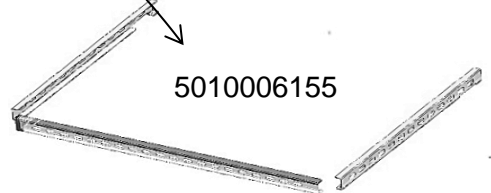

5010004993

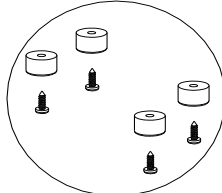

# BARBECUES : PLANCHA BF LXD TWIN

SPARE PARTS REF.	POINTS	EN DESCRIPTIONS	FR DESCRIPTIONS
68038	60	LID HANDLE + SCREWS	POIGNEE COUVERCLE + VIS
5010004742	100	STAINLESS STEEL BURNER 28MB AND 50MB	BRULEUR INOX 28MB ET 50MB
5010004743	50	GREASE CAN	POT A GRAISSE
5010004769	70	ELECTRODES + HOUSING 28MB	ELECTRODES + SUPPORT 28MB
5010004993	40	FEET (x4) + SCREWS	PIED (x4) + VIS
5010005597	180	ELECTRONIC IGNITION SET (2/4 OUTLETS) WITH CONNECTION WIRES	KIT ALLUMAGE ELECTRONIQUE (2/4 SORTIES) AVEC CABLES DE CONNECTIONS
5010005834	40	PUSH BUTTON ELECTRONIC IGNITOR (SILVER CAP)	BOUTTON POUSSOIR TRAIN D'ETINCELLES (BOUTON ARGENTE)
5010006150	60	KNOB (X2) - BLACK	VOLANT (X2) - NOIR
5010006155	80	STAINLESS STEEL FIREBOX FRAME (SIDE AND FRONT BARS)	CADRE DE CUVE INOX (BARRES AVANT ET LATERALES)
5010006158	250	BLACK LID WITH HANDLE, CONNECTION RODS AND BRACKETS	COUVERCLE NOIR AVEC POIGNEE, BIELLETTES ET SUPPORTS
5010006159	900	ENAMELLED CAST IRON COOKING TWIN GRIDDLE - SHINY	PLAQUE DE CUISSON EN 2 PARTIES EN FONTE EMAILLEE - BRILLANTE