

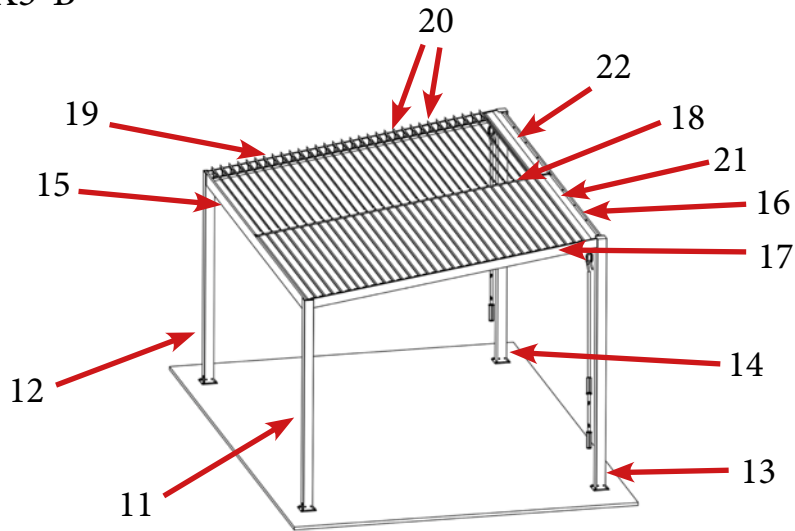

















TRAMONTO-4X3-B

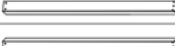

PIECES ET VISSERIE

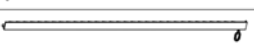
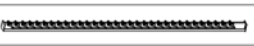
①		PLATINE DE FIXATION 150 x 150 x 35	x 4	⑥		BOULON M8 x 15	x 16
②		CACHE D'EVACUATION Ø34 x 60	x 2	⑦		BOULON M6 x 20	x 22
③		CHEVILLE A BETON M8 x 60	x 4	⑧		BOULON M5 x 15	x 10
④		CACHE BOULON M8	x 16	⑨		RONDELLE Ø20 x Ø10 x 1,0	x 8
⑤		BOULON M8 x 30	x 8	⑩		MANIVELLE A CROCHET 980 x 120	x 2

ARMATURE

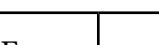
A		POTEAU AVANT GAUCHE	x 1	⑪
B		POTEAU AVANT DROITE	x 1	⑫
C		POTEAU ARRIERE GAUCHE	x 1	⑬
D		POTEAU ARRIERE DROITE	x 1	⑭
E		LONGERON AVANT	x 1	⑮
F		LONGERON ARRIERE	x 1	⑯
G		LONGERON GAUCHE	x 1	⑰
H		LONGERON CENTRAL	x 1	⑱
I		LONGERON DROITE	x 1	⑲
J		LAMES ORIENTABLES	x 64	⑳
K		BANDEAU POUR LAMES GAUCHE	x 1	㉑
L		BANDEAU POUR LAMES DROITE	x 1	㉒

POSITION	DESIGNATION	RÉFÉRENCE	QUANTITÉ
1	Platine de fixation	TRAMONTO-4X3-B-Pc1	4
2	Cache d'évacuation	TRAMONTO-4X3-B-Pc2	2
3	Cheville à béton	TRAMONTO-4X3-B-Pc3	4
4	Cache boulon	TRAMONTO-4X3-B-Pc4	16
5	Boulon M8x30	TRAMONTO-4X3-B-Pc5	8
6	Boulon M8x15	TRAMONTO-4X3-B-Pc6	16
7	Boulon M6x20	TRAMONTO-4X3-B-Pc7	22
8	Boulon M5x15	TRAMONTO-4X3-B-Pc8	10
9	Rondelle	TRAMONTO-4X3-B-Pc9	8
10	Manivelle à crochet	TRAMONTO-4X3-B-Pc10	2
11	Poteau avant gauche	TRAMONTO-4X3-B-PcA	1
12	Poteau avant droite	TRAMONTO-4X3-B-PcB	1
13	Poteau arrière gauche	TRAMONTO-4X3-B-PcC	1
14	Poteau arrière droite	TRAMONTO-4X3-B-PcD	1
15	Longeron avant	TRAMONTO-4X3-B-PcE	1
16	Longeron arrière	TRAMONTO-4X3-B-PcF	1
17	Longeron gauche	TRAMONTO-4X3-B-PcG	1
18	Longeron central	TRAMONTO-4X3-B-PcH	1
19	Longeron droite	TRAMONTO-4X3-B-PcI	1
20	Lames orientables	TRAMONTO-4X3-B-PcJ	64
21	Bandeau pour lames gauche	TRAMONTO-4X3-B-PcK	1
22	Bandeau pour lames droite	TRAMONTO-4X3-B-PcL	1