

ASINDO - PRODUCT FILE

ASINDO REFERENCE 3111-003-ADE	RANGE ANTEA	DESCRIPTIOPN PRODUCT RECTA DINING EXT TABLE
----------------------------------	----------------	--

	Size (cm)	LENGTH (CM) 180	LENGTH EXTENSION (CM) 60	WIDTH (CM) 100,0	HEIGHT (CM) 75,0	
	Box (cm)	TYPE BOX TOP/BOTTOM	UNIT 1	L 184	W 104	H 22





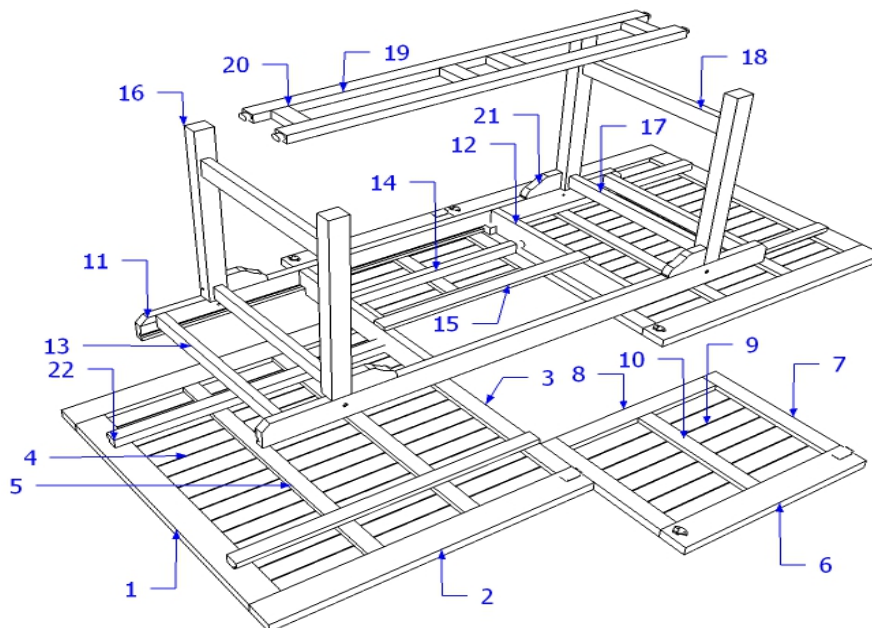



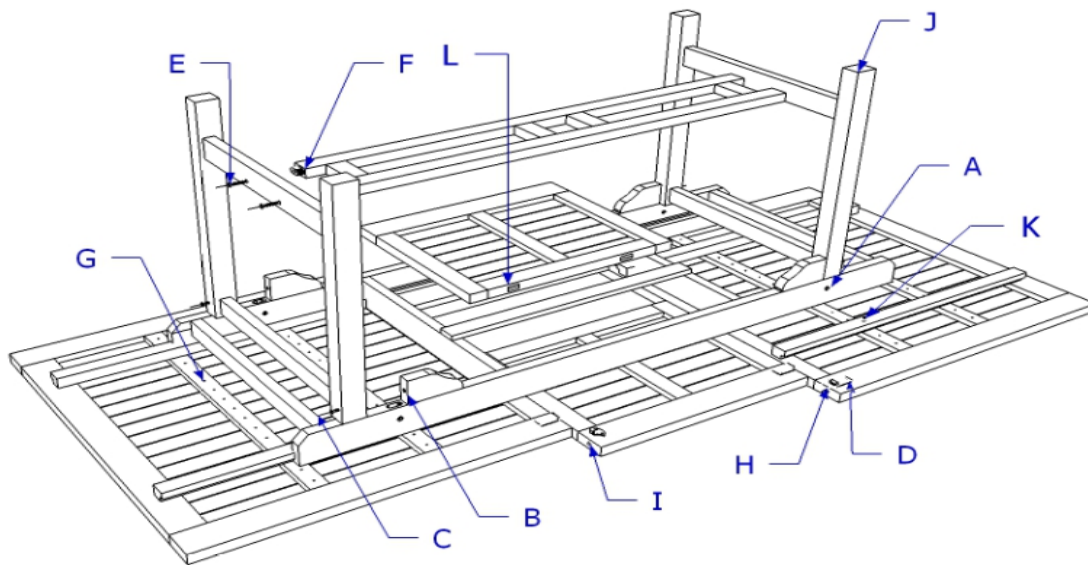

REF.	DESIGNATION	QTY	LENGTH	WIDTH / L (MM)			THICK.	KET.	VOL.	NW
				JML	P(MM)	M				
1	Frame Top 1	2	895	80		80	28	840 25*2+5	0,0040	2546
2	Frame Top 2	4	900	80		80	28	900	0,0081	5121
3	Frame Top 3	2	895	50		50	28	840 25*2+5	0,0025	1591
4	slat top	32	795	50		50	12	770 10*2+5	0,0153	9693
5	supp slat 1	4	885	45		45	16	840 20*2+5	0,0025	1618
6	frame ext. 1	2	600	80		80	28	600	0,0027	1707
7	frame ext. 2	4	475	50		50	28	420 25*2+5	0,0027	1689
8	mid frame	2	555	50		50	28	500 25*2+5	0,0016	987
9	slat ext	14	525	50		50	12	500 10*2+5	0,0044	2800
10	supp slat ext.	2	415	45		45	16	370 20*2+5	0,0006	379
11	apron	2	1740	85		85	28	1740	0,0083	5259
12	supp apron 1	2	645	85		85	28	600 20*2+5	0,0031	1950
13	supp apron 2	2	645	48		48	28	600 20*2+5	0,0017	1101
14	hinge ext	1	705	38		38	28	660 20*2+5	0,0008	476
15	supp top ext	1	720	48		48	18	720	0,0006	395
16	legs	4	635	58		58	48	635	0,0071	4490
17	sup legs top	2	605	48		48	28	560 20*2+5	0,0016	1033
18	sup legs bottom	2	605	58		58	28	560 20*2+5	0,0020	1248
19	cross leg1	2	1270	48		48	28	1250 10*2+5	0,0034	2168
20	cross leg2	4	125	48		48	28	100 10*2+5	0,0007	427
21	corner	4	140	70		70	28	140	0,0011	697
22	rail	4	855	40		40	30	855	0,0041	2606

0,0787
M3 49981
KGS

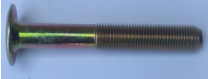

SPARE PART DINING TABLE ANTEA BUTTERFLY

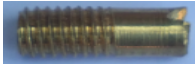

CODE	PICTURE	WEIGHT/G	SIZE/MM			QTY/PCS
			L	W	H	
A		65	29	9	9	4
B		54	30	10	10	4
C		55	70	6	6	4
D		97	68	25	12	4
E		37	45	6	6	4
F		54	30	10	10	4
G		94	25	4	4	78
H/I		154	30	11	11	8
J		10	23	23	6	4
K		27	21	7,5	7,5	4
L		96	46	37	14	2