

**DRAWER H 256 D 380
WIDTH 400**

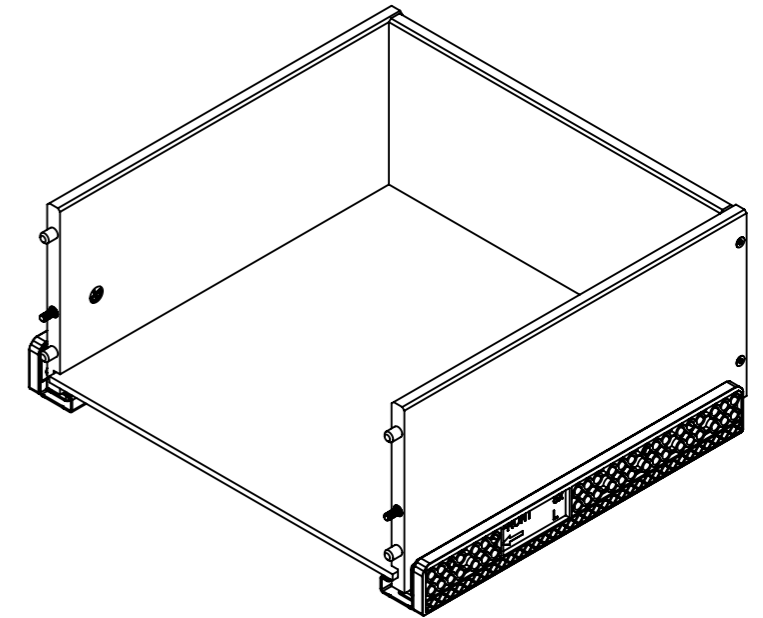
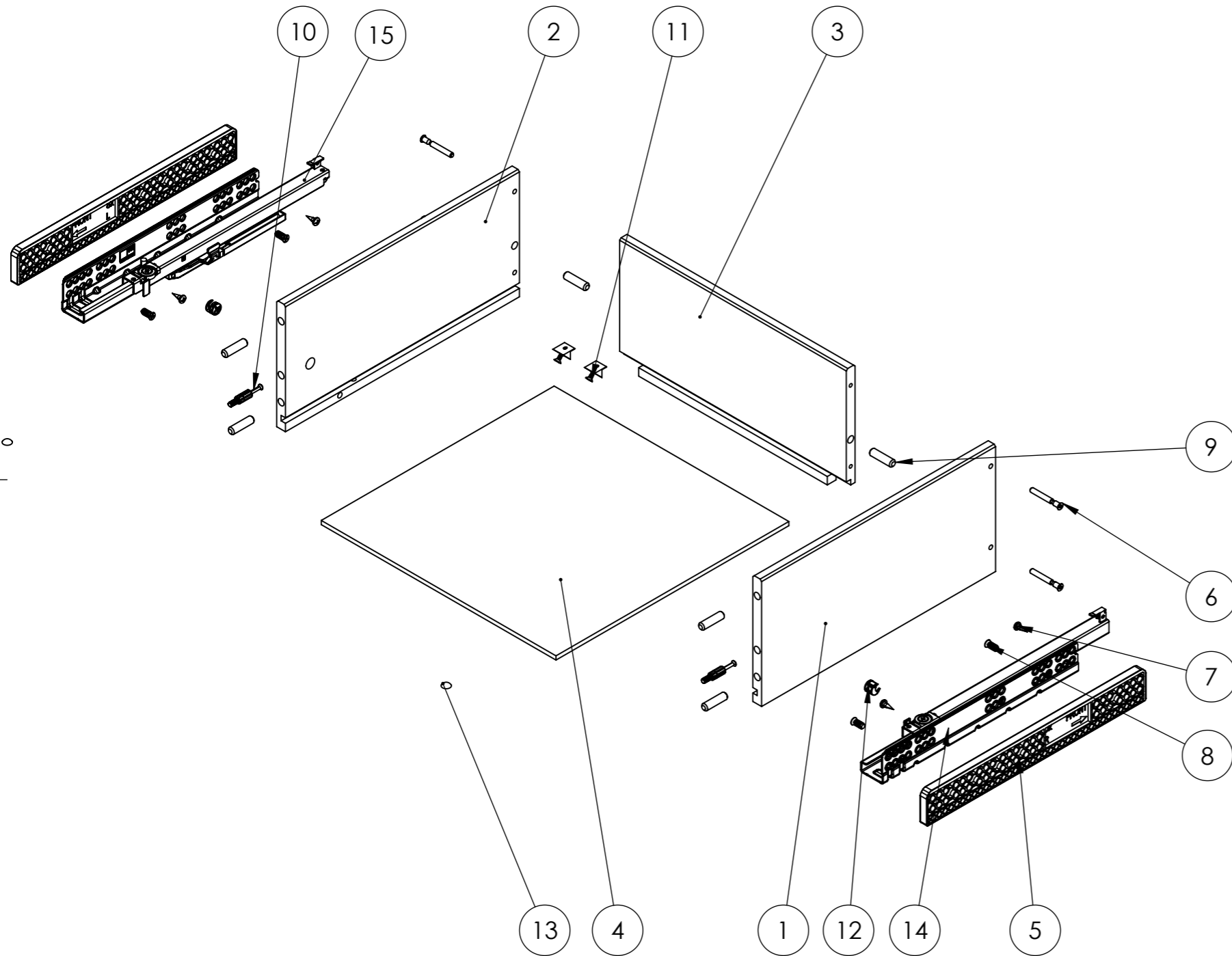

REP	QTY	PART NUMBER	REV	DESCRIPTION
1	1	23R14P03-0002-204	F	Side panel H256 D380 - parametric
2	1	23R14P03-0002-204	F	Side panel H256 D380 - parametric
3	1	23R14P03-0002-302	D	REAR PANEL H256 - PARAMETRIC
4	1	23R14P03-0002-400	F	Bottom panel - parametric
5	2	23R14P03-0002-900	C	COMPENSATOR
6	4	ADEO-0001-0014	A	Screw Direkta hexagonal D5x40
7	4	ADEO-0001-0047	B	VIS 4X20 PZ TF
8	4	ADEO-0001-0050	A	EuroscREW D6.2x18
9	6	ADEO-0002-0001	E	Wood dowel
10	2	ADEO-0002-0004	D	Eccentric axle L34
11	2	ADEO-0002-0008	B	Back panel lock
12	2	ADEO-0002-0009	A	Eccentric box P10 D12
13	2	ADEO-0009-0001	B	Silicon pad
14	1	ADEO-0010-0029	A	SLIDER RIGHT FGV G515H-320
15	1	ADEO-0010-0030	A	SLIDER LEFT FGV G515H-320

MATERIAL:	DO NOT SCALE DRAWING	SHEET 1 OF 3
SURFACE:	REFERENCE:	23R14P03-0002-4 K
TOLERANCE: SEE TECHNICAL SPECIFICATIONS	DESCRIPTION:	
WEIGHT:	DRAWER H 256 D 380	
SCALE: 1:5 UNIT: mm FORMAT: A3	This drawing is the exclusive property of ADEO . Any reproduction in part or whole without the written permission of ADEO is prohibited.	
AUTOR: A.Przadka CHECKER: A.Przadka		
STATUS:		
DATE: 10/10/2022		