

**DRAWER H 384 D 380
WIDTH 800**

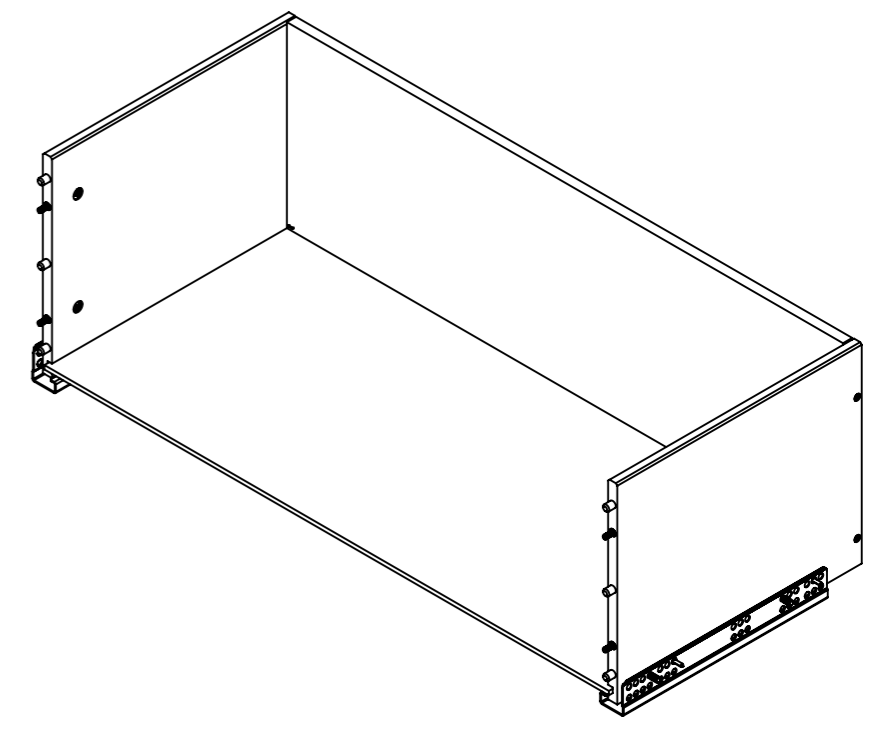
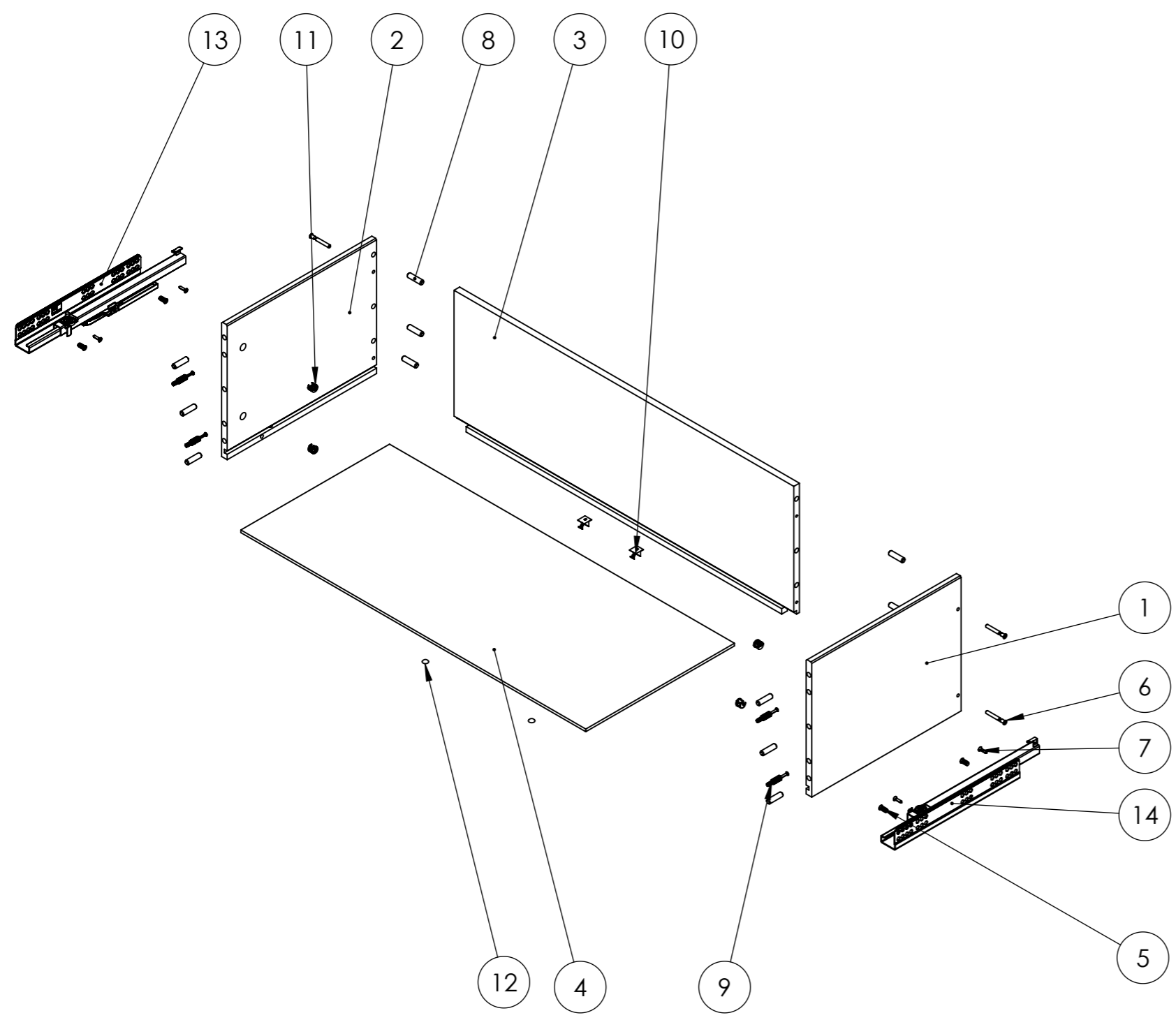

REP	QTY	PART NUMBER	REV	DESCRIPTION
1	1	23R14P03-0002-207	F	Side panel H384 D380 - parametric
2	1	23R14P03-0002-207	F	Side panel H384 D380 - parametric
3	1	23R14P03-0002-303	E	REAR PANEL H384 - PARAMETRIC
4	1	23R14P03-0002-400	F	Bottom panel - parametric
5	4	ADEO-0001-0002	B	EuroscREW D6.2x13.5
6	4	ADEO-0001-0014	A	Screw Direkta hexagonal D5x40
7	4	ADEO-0001-0051	B	Vis 4x15 TF
8	12	ADEO-0002-0001	E	Wood dowel
9	4	ADEO-0002-0004	D	Eccentric axle L34
10	2	ADEO-0002-0008	B	Back panel lock
11	4	ADEO-0002-0009	A	Eccentric box P10 D12
12	2	ADEO-0009-0001	B	Silicon pad
13	1	ADEO-0010-0043	A	SLIDER LEFT FGV G515H 320
14	1	ADEO-0010-0044	A	SLIDER RIGHT FGV G515H 320

MATERIAL:	DO NOT SCALE DRAWING	SHEET 3 OF 3
SURFACE:	REFERENCE:	23R14P03-0002-7 I
TOLERANCE: SEE TECHNICAL SPECIFICATIONS	DESCRIPTION:	
WEIGHT:	DRAWER H 384 D 380	
SCALE: 1:5 UNIT: mm FORMAT: A3	This drawing is the exclusive property of ADEO . Any reproduction in part or whole without the written permission of ADEO is prohibited.	
AUTOR: A.Przadka CHECKER: A.Przadka		
STATUS:		
DATE: 30/09/2022		