

Technical drawings with tolerances

L2 range

HIGH RESIN CABINET XL 90 CM

MATRIX ID - 2022R14P02-0007

Gtin 13: 3276007359206



HIGH RESIN CABINET XL 90 CM

MATRIX ID - 2022R14P02-0007

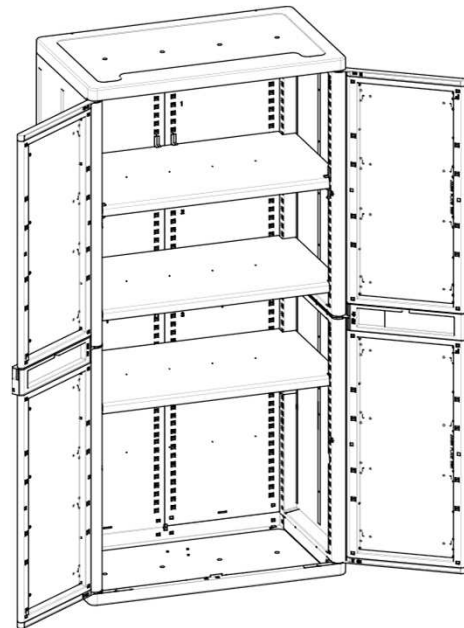
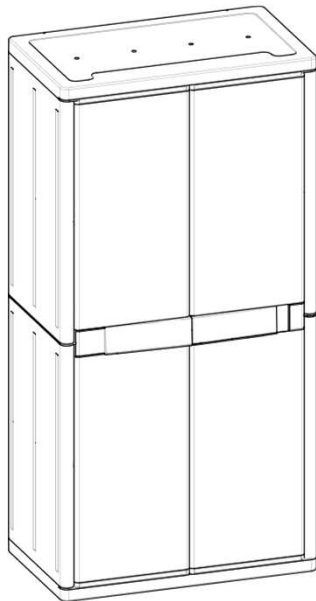
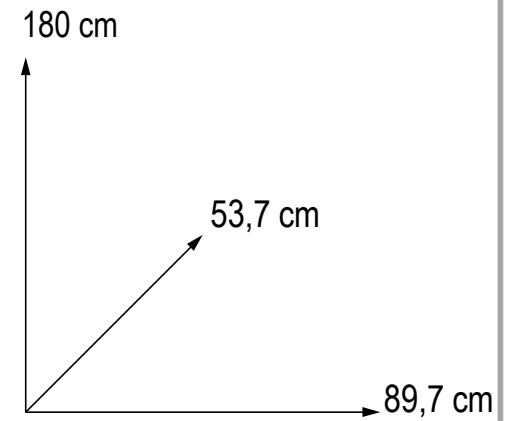

Tolerance on overall dimensions: +/- 10 mm

Overall gross weight (including packaging) : 24.500 gr with tolerance of +/- 5%

Exploded View

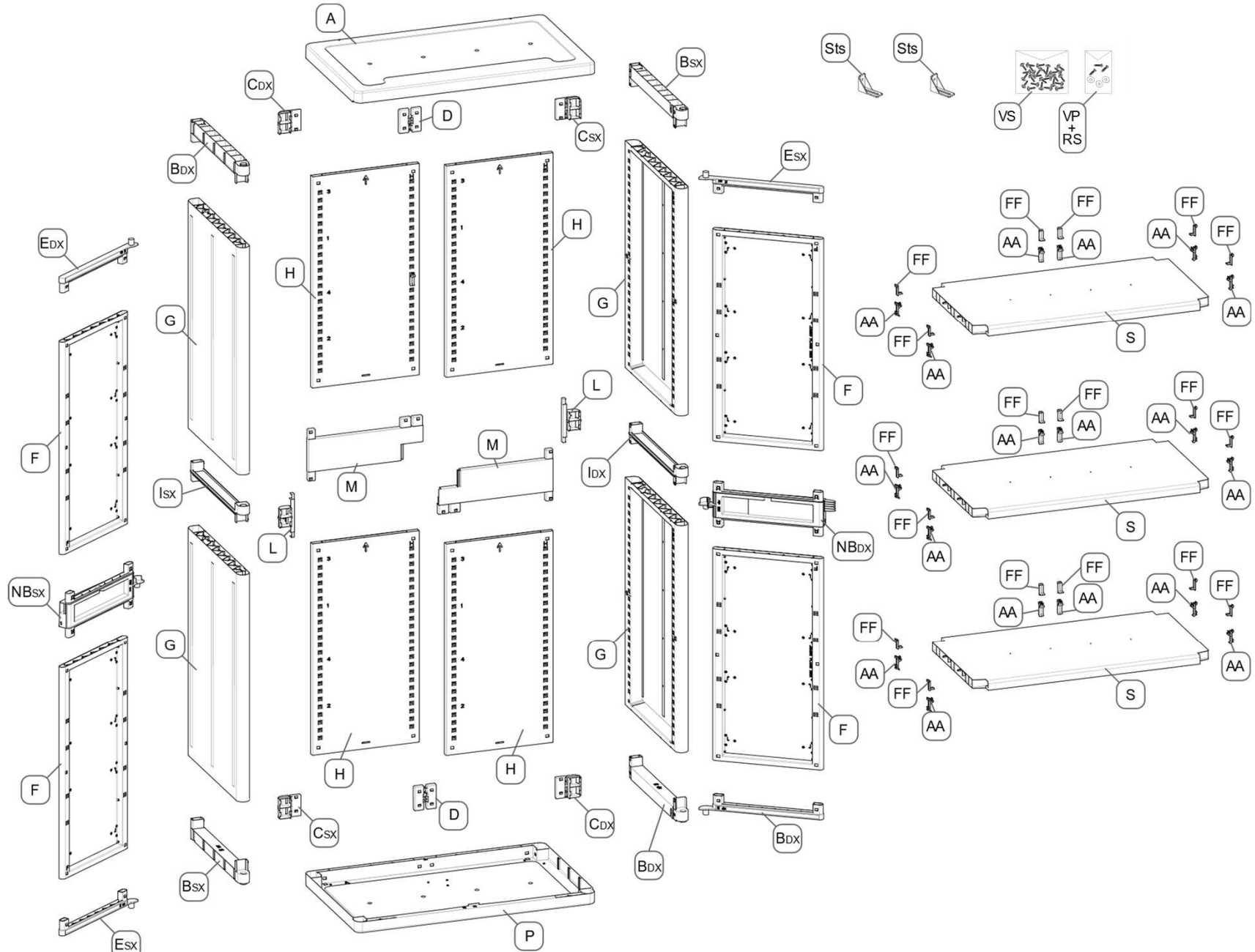

- Material shrinkage coefficient (PP): 1.8%
- Tolerance on indicated dimensions: +/- 0,5 mm
- Texture: Same of other molds of the same product family
- Color: grey PP (4000024)

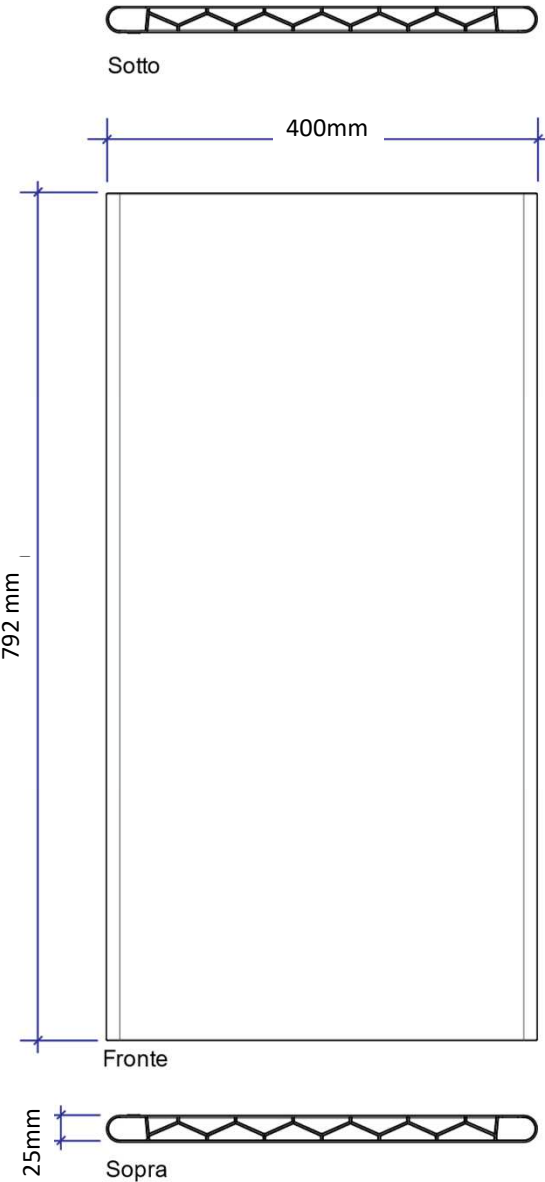
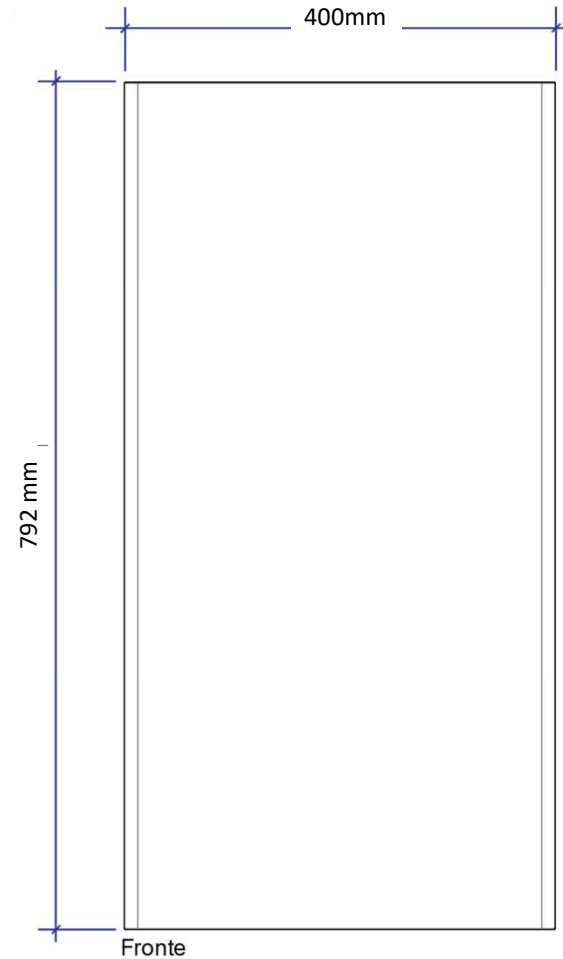
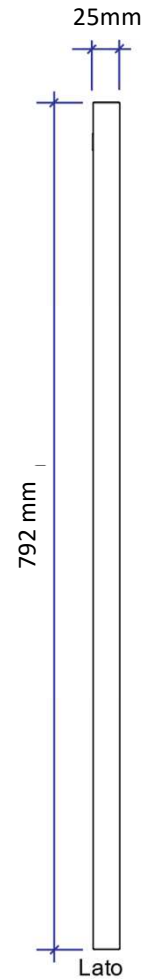
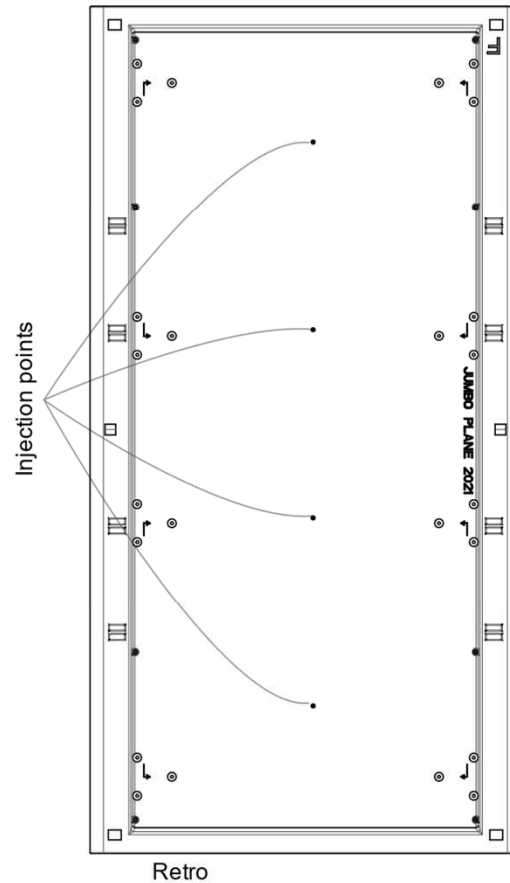
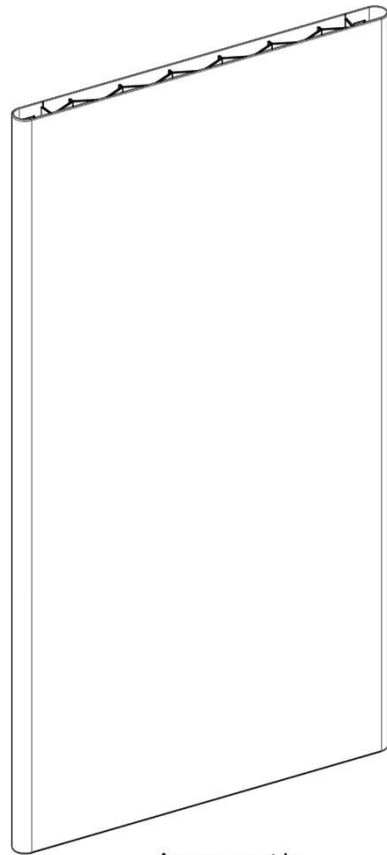

F

New Flat Door panel Jumbo XL (F)

- Material shrinkage coefficient (PP): 1.8%
- Tolerance on indicated dimensions: +/- 0,5 mm
- Texture: Same of other molds of the same product family
- Color: black PP (400022)

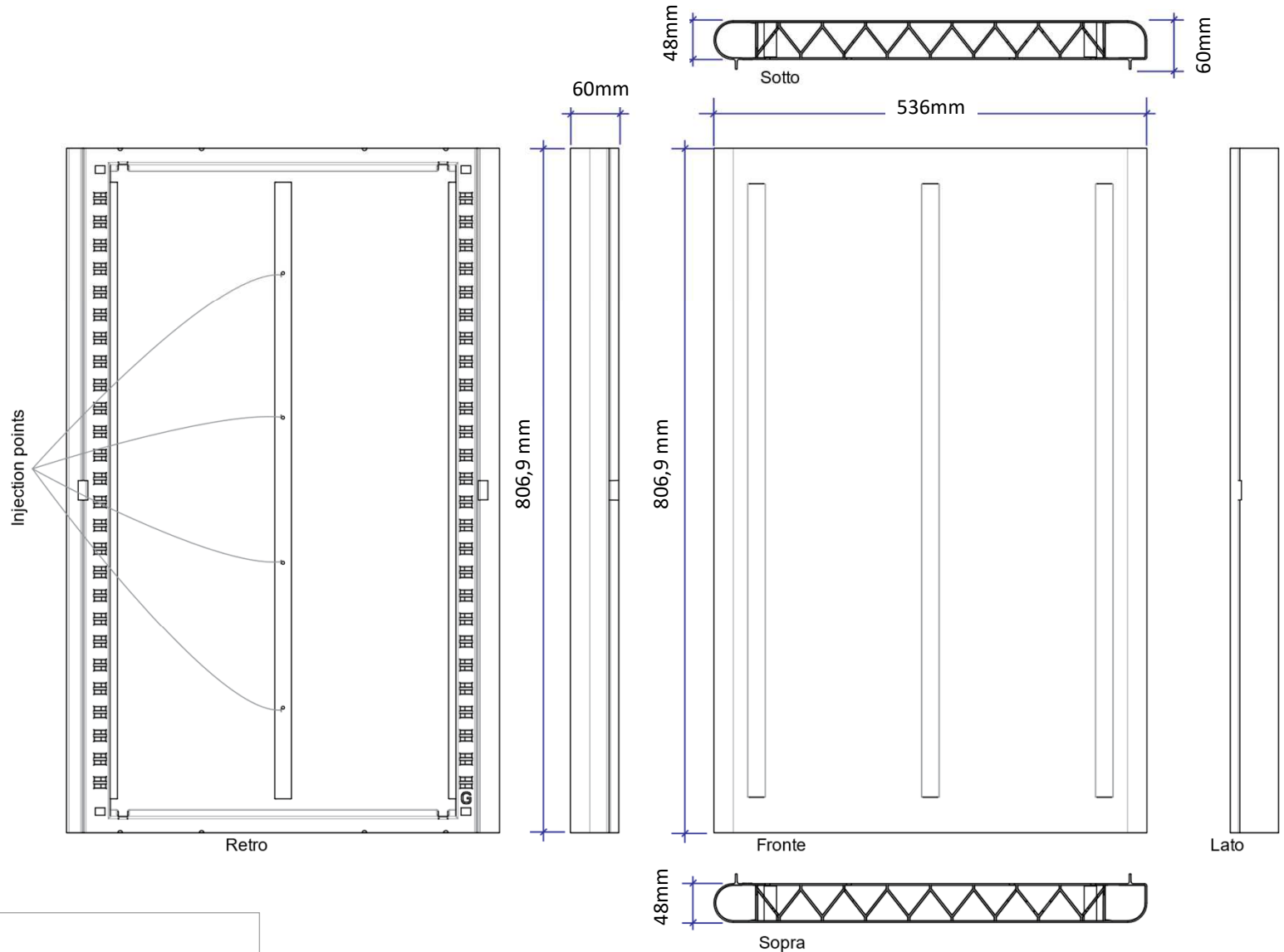
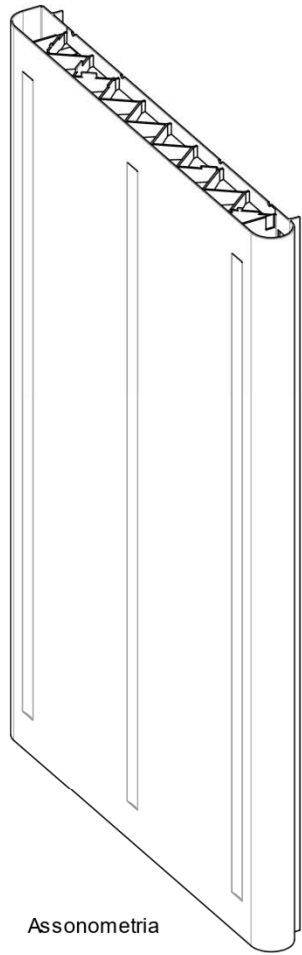

G

Side Panel (G)

- Material shrinkage coefficient (PP): 1.8%
- Tolerance on indicated dimensions: +/- 0,5 mm
- Texture: Same of other molds of the same product family
- Color: black PP (4000022)

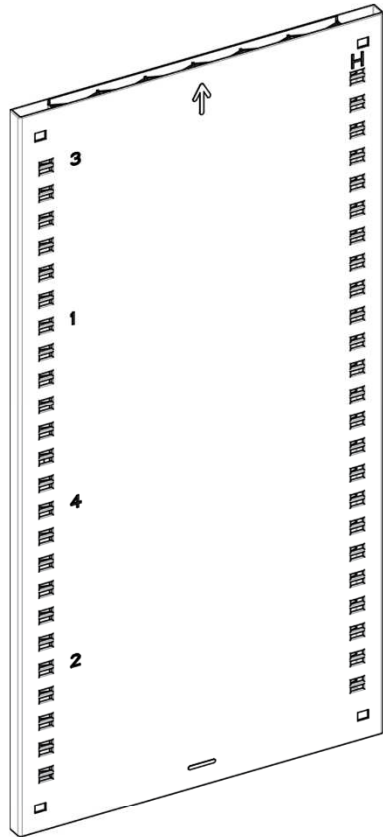

Assonometria

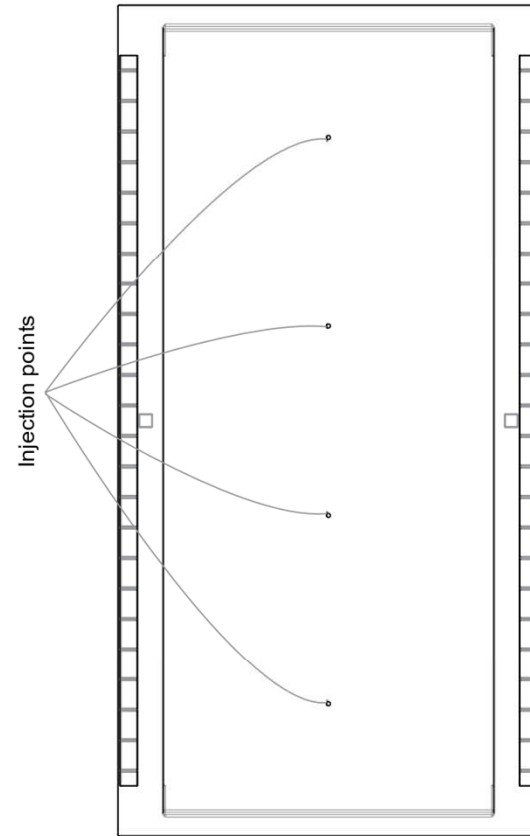

Injection points

Retro

19mm



Lato

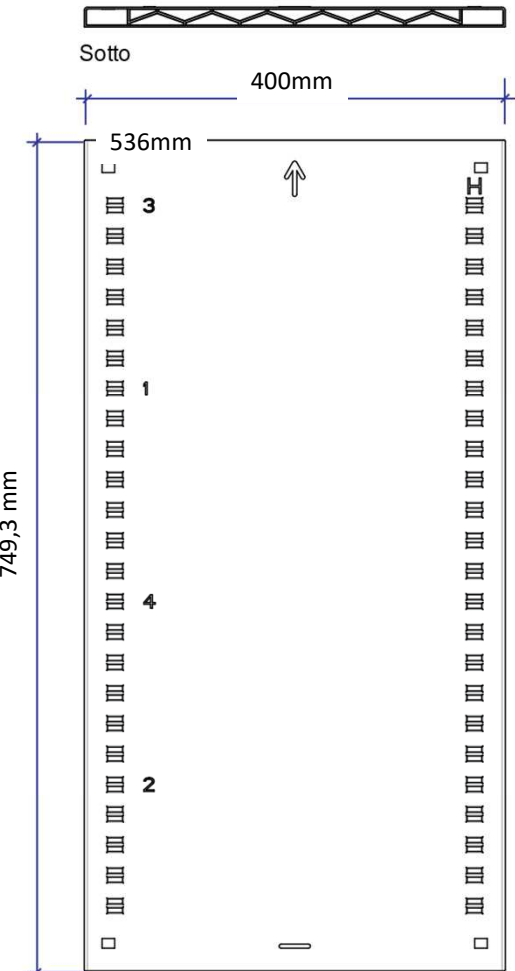

Fronte



Sopra

H

Back Panel (H)

- Material shrinkage coefficient (PP): 1.8%
- Tolerance on indicated dimensions: +/- 0,5 mm
- Texture: Same of other molds of the same product family
- Color: black PP (4000022)

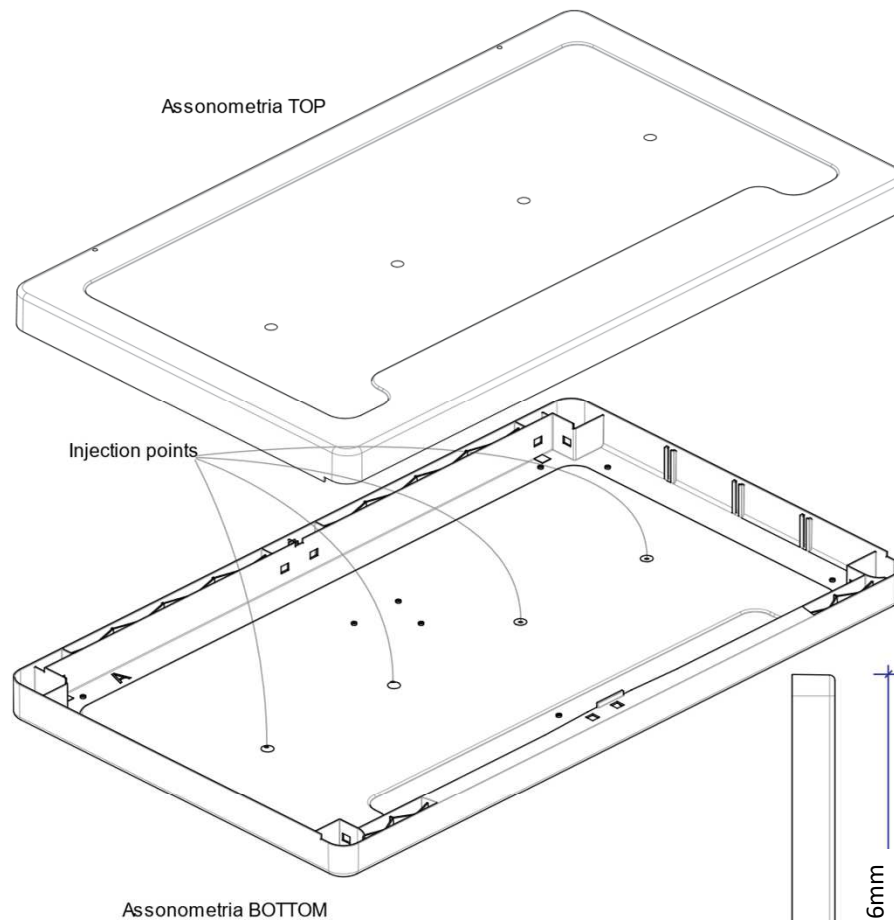

Sopra



Fronte

48 mm

894,3 mm

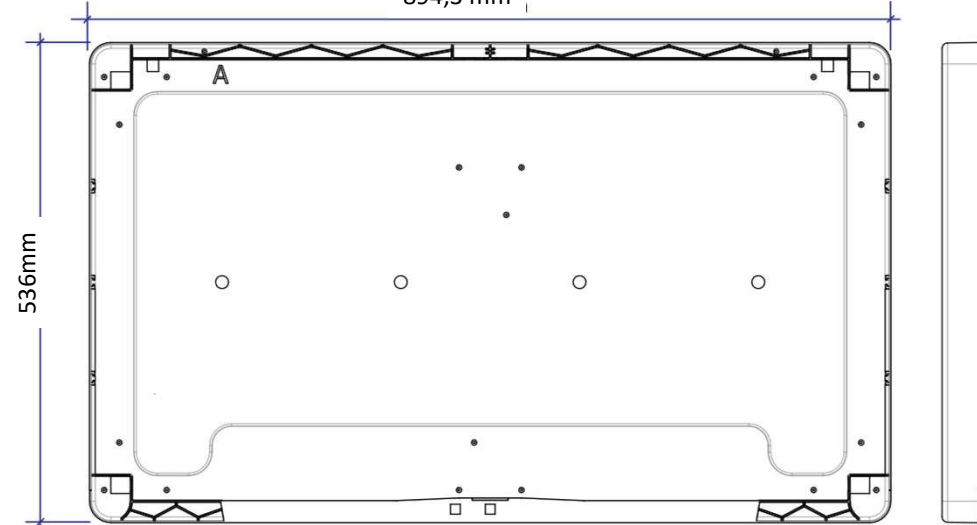

536 mm

Lato

Sotto

Lato

A

Top Bottom (A)

- Material shrinkage coefficient (PP): 1.8%
- Tolerance on indicated dimensions: +/- 0,5 mm
- Texture: Same of other molds of the same product family
- Color: black PP (4000022)

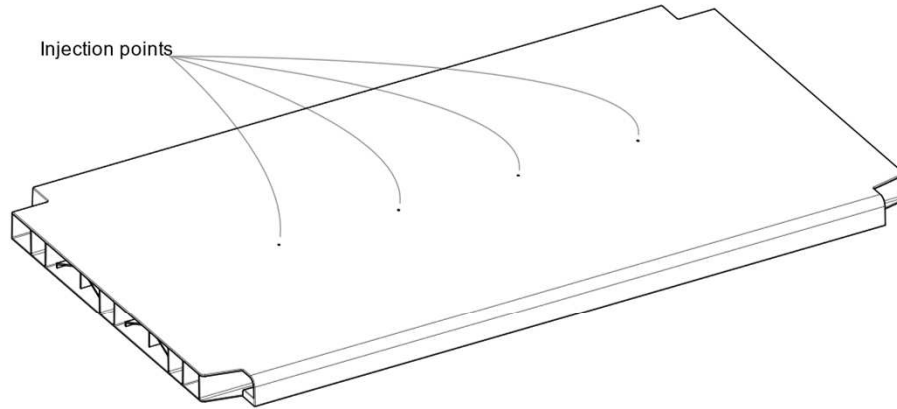

Assonometria

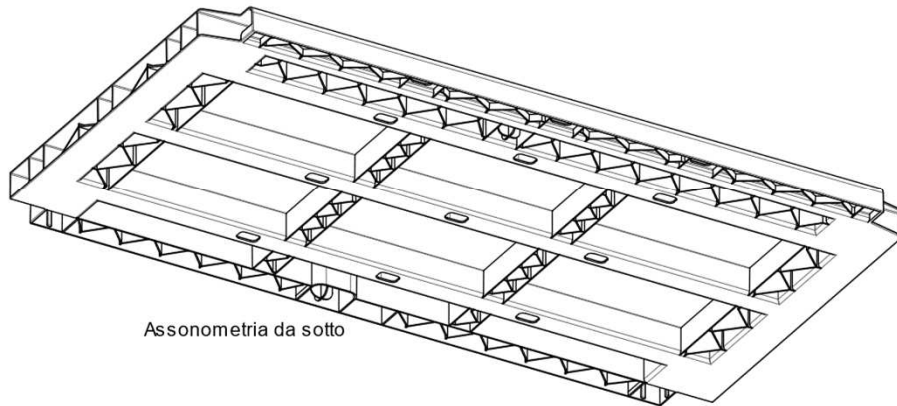

Assonometria da sotto

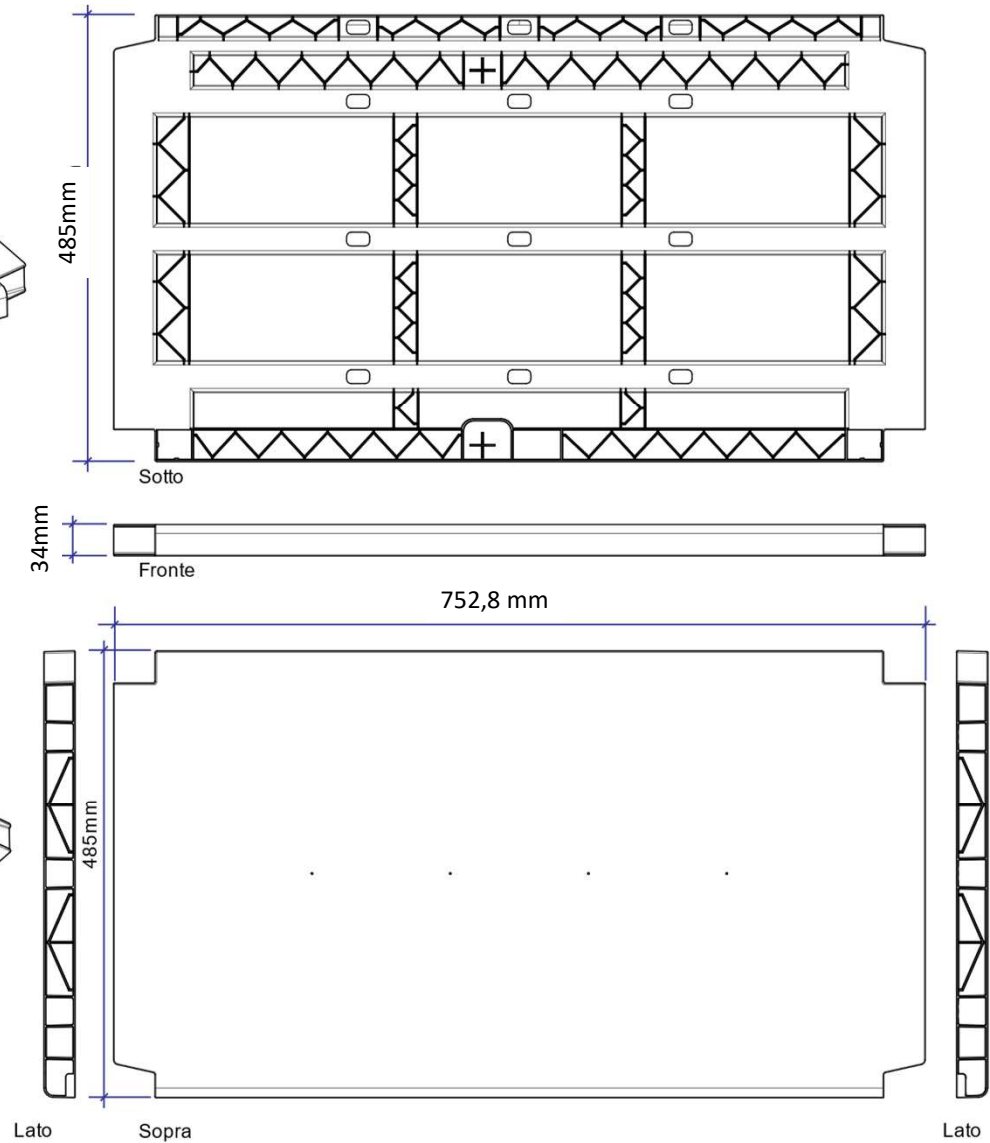

S

New inner shelf (S)

- Material shrinkage coefficient (PP): 1.8%
- Texture: Same of other molds of the same product family
- Color: black PP (4000022)

Kit Side belts jumbo XL (I)

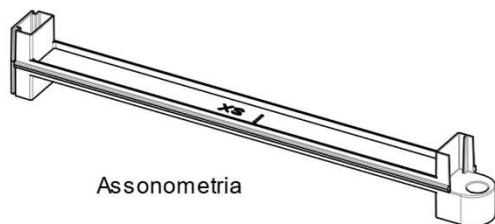

Assonometria



Sotto

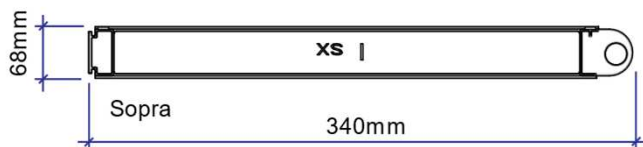

Retro

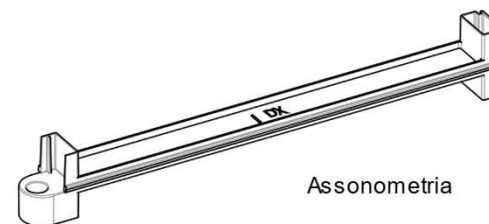

Assonometria



Sotto

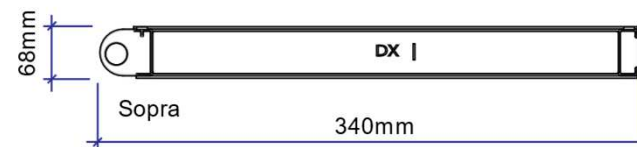

Retro

ISX

IDX

- Material shrinkage coefficient (PP): 1.8%
- Texture: Same of other molds of the same product family
- Color: black PP (4000022)

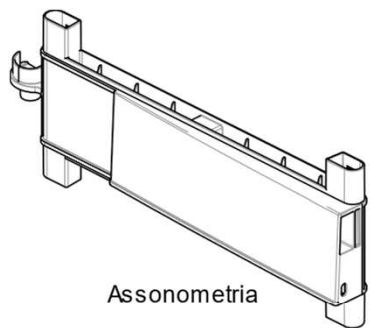

Assonometria

448,5mm

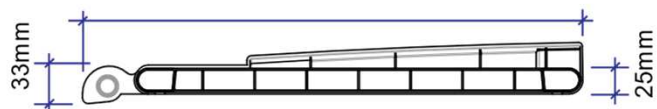

Sotto

402mm

25mm

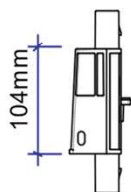

Lato

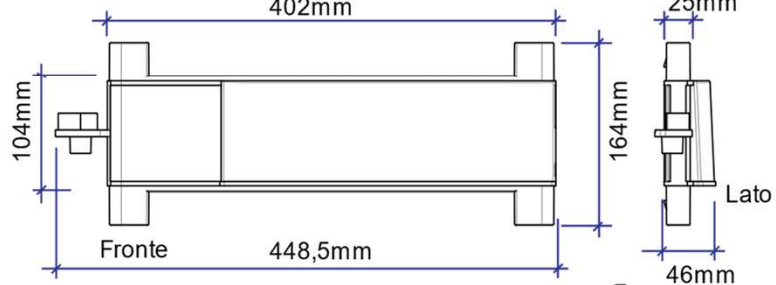

Fronte

448,5mm

Lato

46mm



Sopra

46mm

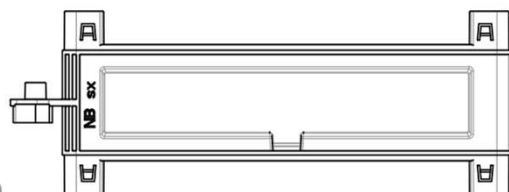

Retro

NBSX

Kit Door belts Handle Jumbo XL (NB)

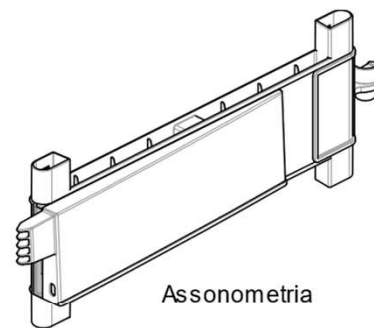

Assonometria

490mm

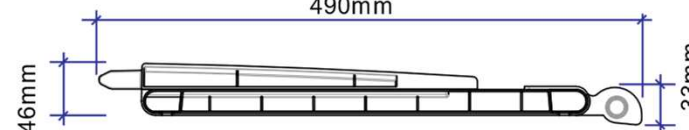

Sotto

450mm

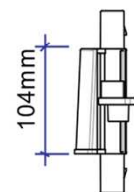

Lato

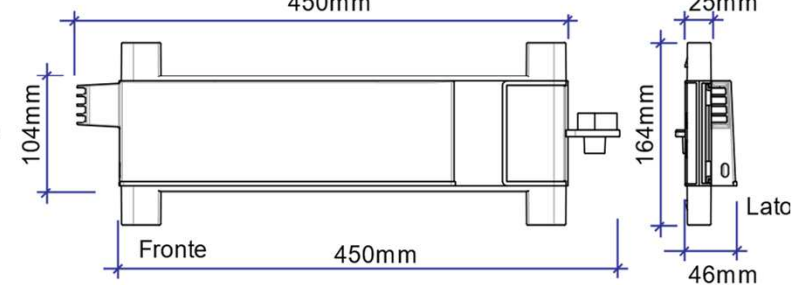

Fronte

450mm

Lato

46mm

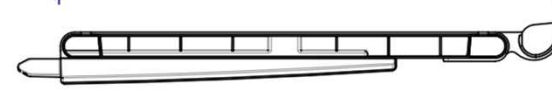

Sopra

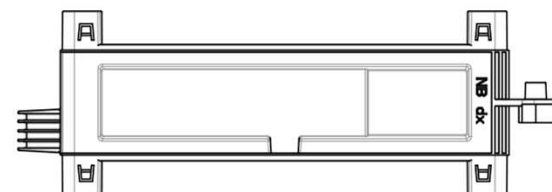

Retro

NBDX

- Material shrinkage coefficient (PP): 1.8%
- Texture: Same of other molds of the same product family
- Color: black PP (4000022)

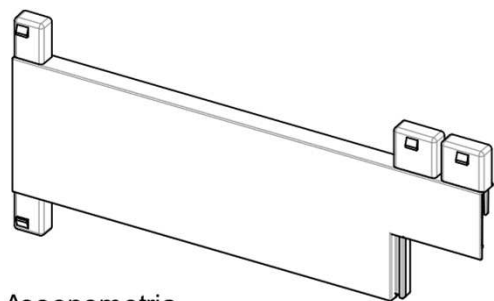

Assonometria

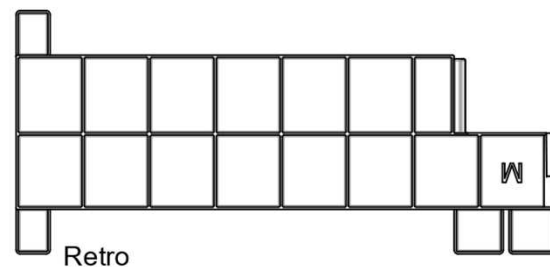

Retro



Sotto

19mm

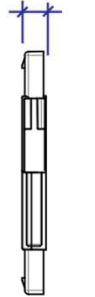

Lato

340mm

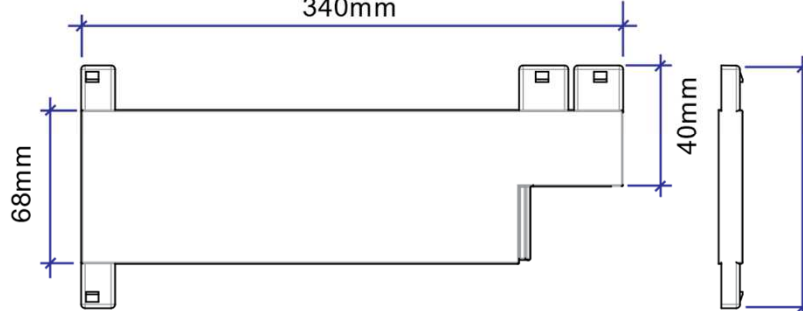

Fronte

68mm

40mm

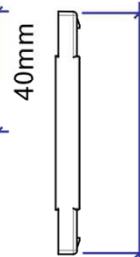

Lato

40mm

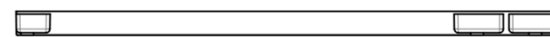

Sopra

M

Kit Back belts jumbo XL (M)

- Material shrinkage coefficient (PP): 1.8%
- Texture: Same of other molds of the same product family
- Color: black PP (4000022)

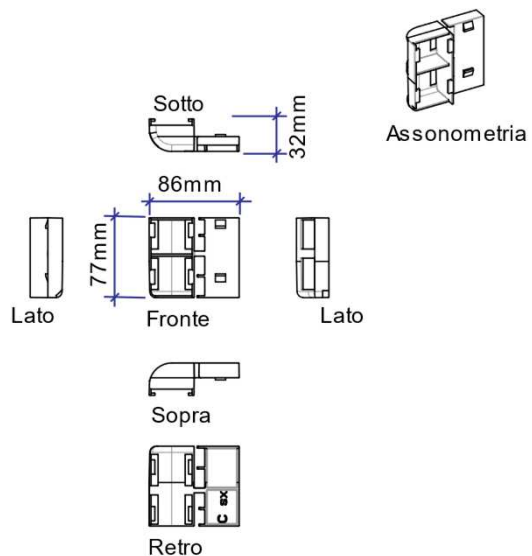

CSX

Kit Components Jumbo XL (C+D+L)

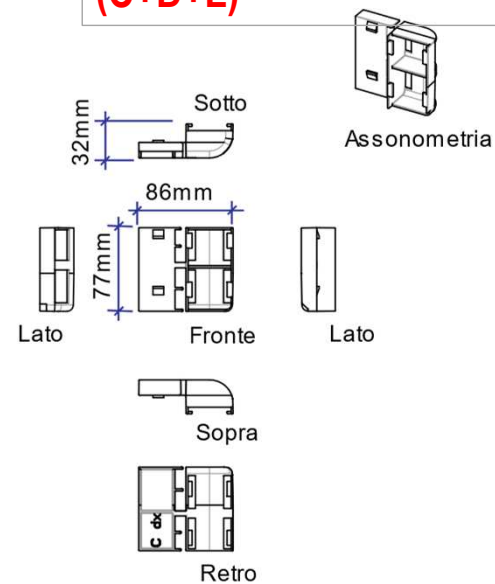

CDX

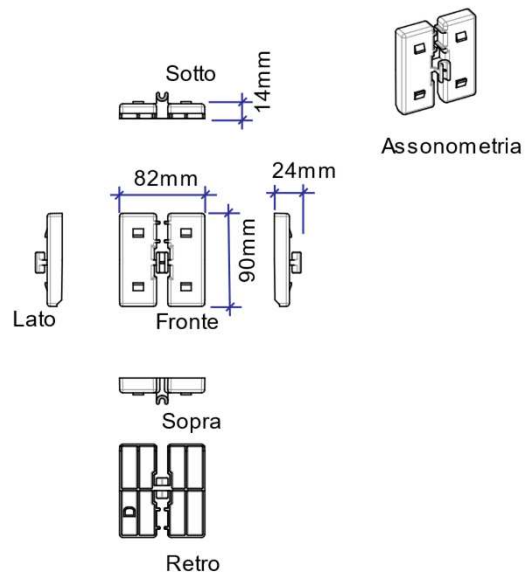

D

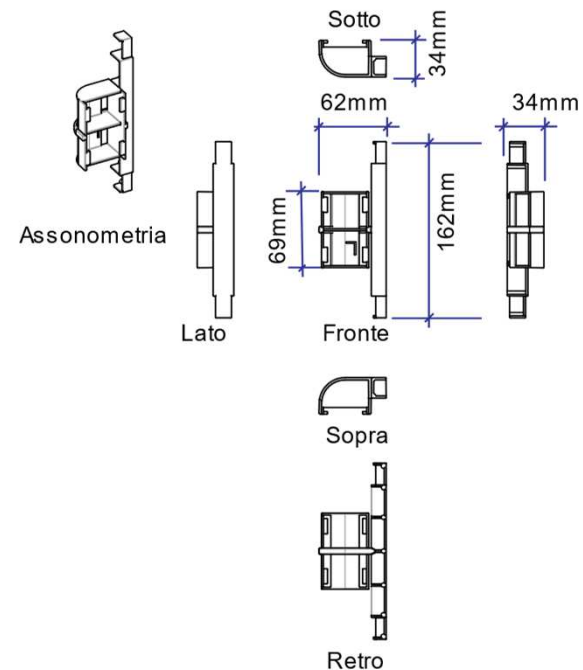

L

- Material shrinkage coefficient (PP): 1.8%
- Texture: Same of other molds of the same product family
- Color: black PP (4000022)

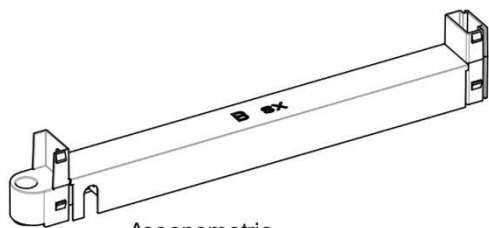

Assonometria

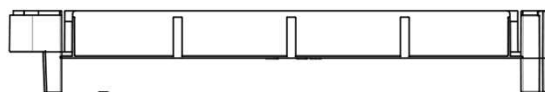

Retro



Sotto

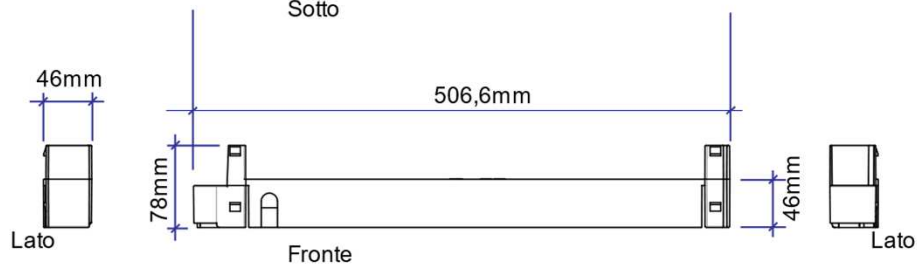

Lato

Fronte

Lato



Sopra

BSX

Kit Hinges Jumbo XL (B+E)

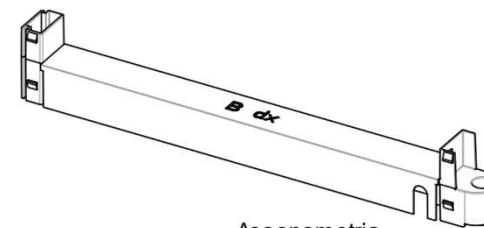

Assonometria

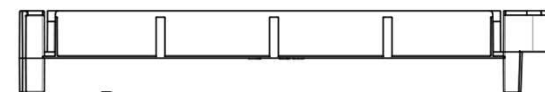

Retro



Sotto



Lato

Fronte

510mm

Lato



Sopra

BDX

Plinth kit - XL 90CM

- Material shrinkage coefficient (PP): 1.8%
- Texture: Same of other molds of the same product family
- Color: black PP (4000022)

Kit Hinges Jumno XL (B+E)

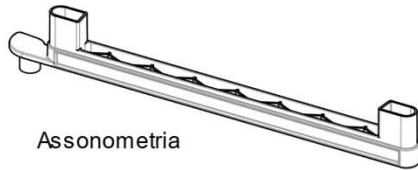

Assonometria

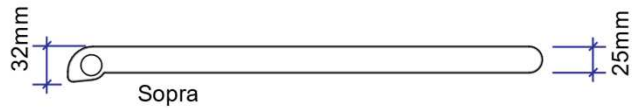

Sopra

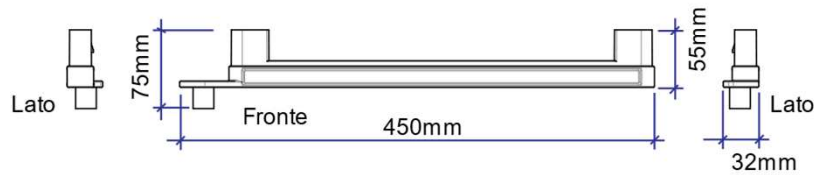

Fronte

Lato



Sotto



Retro

ESX



Assonometria

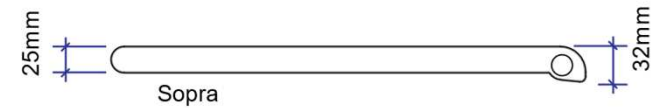

Sopra

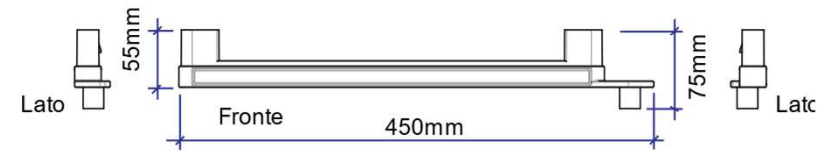

Fronte

Latc



Sotto



Retro

EDX

- Material shrinkage coefficient (PP): 1.8%
- Texture: Same of other molds of the same product family
- Color: black PP (4000022)



Assonometria

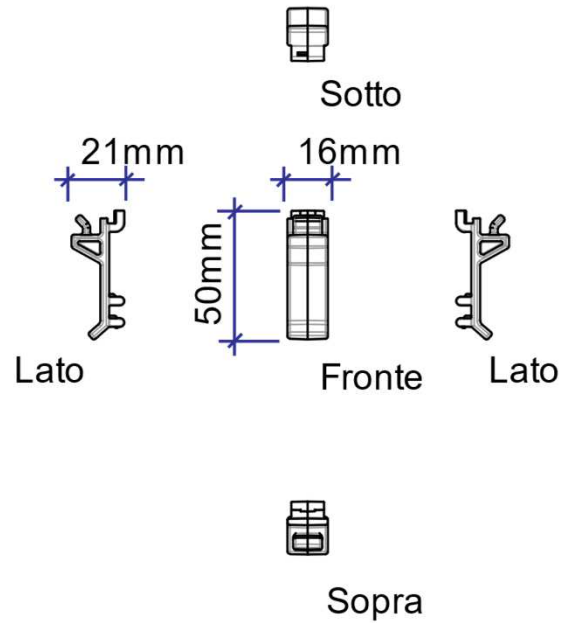

AA

Inner shelf holders kit (AA+FF)



Assonometria

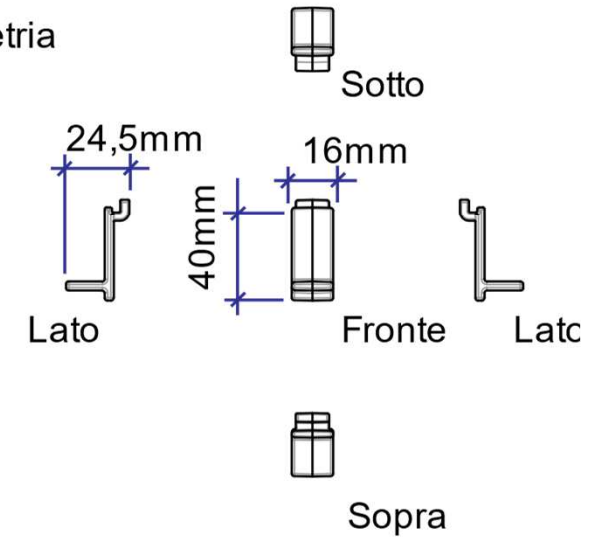

FF