

Safety First

IMPORTANT!

READ THIS SAFETY GUIDE CAREFULLY BEFORE USE. KEEP FOR FUTURE REFERENCE

- ① **Safe Operation Practices**
- ② **Symbols Definitions**
- ③ **Safety Features**



Do not allow children to use or operate the mower. Children must be supervised at all times.

This guide includes the original manufacturer's instructions in terms of Directives 2006/42/EC and 2014/53/EU. It may describe models that are not available in your country.

Please note the terminology below when using this guide.

Front and Rear of the mower:

The Front is the opposite side of the (red) STOP control. It is the direction of travel of the mower and where the passive wheel/s are located.

The Rear is where the (red) STOP control is located, and where the traction drive wheels are located.

Left and Right directions are determined when standing behind the Rear of the mower and looking at its Front.

Safety Guidelines



DANGER

Describes situations, where, if the hazard is not avoided, it will cause death or serious injury.



WARNING

Describes situations, where, if the hazard is not avoided, it may result in death or serious injury.



CAUTION

Describes situations, where, if the hazard is not avoided, it could result in minor or moderate injury, or damage to property and/or the product.



Provides information for proper use of the product and avoidance of possible operation malfunctions.

Important Safety Information



WARNING

It is your responsibility to:

- Restrict the use of this mower to persons who have read, understood and follow the warnings and instructions in this guide and in the mower
- Inform your neighbors you have a robot mower in operation and that they may be injured if they enter your lawn during operation



DANGER

Always connect the power supply to the indoor, weather-protected power outlet! Follow local electric installation instructions.



WARNING

Allow the blades to completely stop rotating before lifting or tilting the mower or approaching the blades.



DANGER

Do not connect a damaged power cord to the supply and do not touch such cord as it can cause electric shock.

Keep all power cords away from underneath the mower to prevent damage.



Safe Operation Practices

A. General Information

1. Read, understand and follow all instructions on the mower and in the manual(s) before attempting to assemble and operate. Keep this manual in a safe place for future and regular reference and for ordering replacement parts.
2. Be familiar with all controls and their proper operation.
3. It is your responsibility to inform your neighbors you have a robotic mower and the risk of injury if they enter your lawn during its operation.
4. If your lawn is open to the street and/or your neighbor's property, you must be present during the mower's operation to prevent others from contacting the mower during operation. Alternatively, you must fence your lawn so that others do not access the lawn during operation.
5. Never allow children under 14 years of age to operate the mower using the remote control app. Children 14 and over should read and understand the instructions and safe operation practices in this manual and on the mower and should be trained and supervised by an adult.
6. Never allow children, persons with reduced physical, sensory or mental capabilities, or people who are unfamiliar with these instructions to operate the mower.
7. If situations occur which are not covered in this manual, use care and good judgment. Contact your customer service representative for assistance.
8. This mower is a precision piece of power equipment, not a plaything. Therefore, exercise extreme caution at all times. This mower has been designed to perform one job: to mow grass. Do not use it for any other purpose.

B. Preparations Before Operating



PRIOR TO FIRST USE, ENSURE THAT PRODUCT HAS BEEN CHARGED CONTINUOUSLY FOR 48 HOURS.

1. Ensure the correct installation of the Perimeter Wire, as instructed later in this manual.
2. Thoroughly inspect the area where the mower is to be used. Remove all stones, sticks, wire, bones, toys and other foreign objects which could damage the blade or be picked up and thrown by the blade. Thrown objects can cause serious personal injury.
3. Keep bystanders, children and pets inside while the mower is in operation. Stop mower if anyone enters the mowing area.
4. When there is a risk of a lightning storm, keep the mower in a protected area and disconnect the power supply.

C. Operation



WARNING!

Do not allow the mower to operate unattended if you know that there are or may be pets, children or people in the vicinity.

1. Your robotic mower is a dangerous power tool. Exercise care when operating it and follow all safety instructions and warnings.
2. In the event of an accident or malfunction during operation immediately press the red STOP control.
3. Do not allow your mower to operate if any safety feature or any part is damaged, worn or inoperable.
4. Always remove the disabling key before lifting the mower or making any adjustments. Removing the key disables power to the wheel drive and blade.
5. Never pick up or carry the mower while the wheels are turning or blade is moving. Do not touch the blade before it has completely stopped rotating.
6. Do not use the mower for any purpose other than cutting grass.
7. Never attempt to bypass a safety device, or to remove a guard or cover. Doing so may result in personal injury through contact with the rotating blade. The sensors are safety devices.
8. The cutting blade continues to rotate for up to two (2) seconds after a safety sensor is triggered or the red STOP control is pressed. Never place any part of the body in the blade area until you are certain the blade has stopped rotating.
9. If the mower should start to vibrate abnormally, stop the motor and check immediately for the cause. Vibration is generally a warning of trouble.
10. Always wear safety glasses during remote control operation and while performing an adjustment or repair to protect your eyes. Thrown objects which ricochet can cause serious injury to the eyes.
11. Never operate mower with a damaged safety device, guard or cover. Failure to follow this warning can result in personal injury.
12. Do not put hands or feet near rotating parts or under the cutting deck. Contact with the blade(s) can amputate hands and feet.
13. Watch for holes, ruts, bumps, rocks or other hidden objects. Uneven terrain or hidden objects could cause an accident. Tall grass can hide obstacles.
14. Your mower is designed to cut normal residential grass of a height no more than 6" (15 cm). Do not attempt to mow through unusually tall

1. grass (e.g., pasture).
2. Do not operate the mower without the cover door closed.
3. Set the weekly program so the mower is in operation when there are no people likely to be on the grass.
4. Do not connect a damaged power cord to the supply, or touch a damaged cord before it is disconnected from the supply as it can lead to electric shock.
5. Keep all power cords away from underneath the mower to prevent damage. A damaged power supply cord can lead to electric shock.
6. Operate the mower manually only when it is within your range of vision. Stay within 6 meters of the mower when you are operating it manually.

D. Children

1. Tragic accidents can occur if you are not alert to the presence of children. Children are often attracted to the mower and the mowing activity. They do not understand the dangers. Never assume that children will remain where you last saw them. Never assume that children will stay away from the mower while it is operating.
2. Keep bystanders, children and pets inside while the mower is in operation and under the watchful care of a responsible adult. Stop mower if anyone enters the area.
3. Be alert and turn the mower off if a child or bystander enters the area.
4. Do not allow children to ride on the mower. It is not a toy.
5. Never allow children to play in the yard while the mower is in operation. Teach your children that the mower is dangerous and they must stay away from it.
6. Never allow children under 14 years of age to operate this mower using the remote control app. Children 14 and over should read and understand the instructions and safe operation practices in this manual and on the mower and should be trained and supervised by an adult.

E. Transportation

Before moving or transporting your mower, follow the steps below:

1. Press or pull the red STOP control to stop the mower.
2. You may use the Remote Control (available as an accessory or via the mobile app) to drive your mower from one place to another.
3. If you select to carry your mower:
 - For RK models: Press the red STOP control and remove the disabling key before carrying the mower. Switch the mower off by pressing the "OFF" button located under the interface door on top of the mower. The red STOP control is also a carrying handle."
4. Always carry with blades facing away from you. Be careful to avoid contacting the sharp edge of the blade when lifting or carrying the mower.

F. Remote Operation

1. Refer to the separate operator's manual provided with the downloadable app. Follow all warnings and instructions provided.
2. Always operate the mower according to the app instructions while standing away from the mower.
3. Keep a safe distance between you and the mower when it is in operation. Always stop the mower operation before approaching it for any reason.
4. Use extreme caution when operating the mower towards you.
5. Operate the mower by remotely only in daylight or in good artificial light, and avoid operating on wet grass.
6. Never operate the mower remotely in bare feet, sandals, slippery or lightweight (e.g. canvas) shoes. Always wear substantial footwear and long pants; always make sure of your footing on slopes.

G. Batteries

1. Use only genuine batteries provided by the manufacturer.
2. Do not open, drop, or damage the sealed Battery Pack. Do not use the battery with visible defects or deformations, when it is broken or cracked
3. **DO NOT ATTEMPT TO REPAIR OR MODIFY BATTERIES!** Repair attempts may result in severe personal injury, due to explosion or electrical shock. If a leak develops, released electrolytes are corrosive and toxic
4. Do not attempt to remove or destroy any of the battery components.
5. The Battery Pack contains electrolytes. In the case of electrolyte leakage from the Battery Pack, the following action should be taken:
 - Skin contact: Wash the contact areas off immediately with water and soap.
 - Eye contact: Flush the eyes with plenty of clean water for at least 15 minutes. Do not rub.
 - Get medical assistance.
6. Do not dispose of the battery in a fire. The cell may explode.
7. The battery is intended to be charged when it is inside the mower and properly connected to the mower. Always use the power supply provided with the mower. Incorrect usage may result in electric shock, overheating or fire.
8. Do not use the battery for any purpose other than powering the dedicated Robotic Lawnmower. Altering the battery to make it powering another product is extremely unsafe.
9. Observe proper disposal laws and regulations for batteries to protect the environment. Refer to the "Rechargeable Battery Disposal" section of this User Guide for additional information.

H. Slope Operation

1. All slopes require extra caution. If you feel the mower cannot maintain traction on the slope, it is too steep to mow. Wet grass will decrease traction and may cause the mower to slip and slide on the slope. Serious injury or property damage could result.
2. For your safety, measure any slope before using the mower on the sloped area. Use a slope measuring device before setting up the mowing zones or operating this mower on a sloped or hilly area. Smart phone applications can also be utilized to measure slopes. If the slope at the perimeter is greater than 15 degrees (27%), RT models may slide out of the mowing zone. For RK models mower may slide out of the mowing zone at 24 degrees (45%).
3. Do not mow on slopes greater than 15 degrees (27%) with RT models and greater than 24 degrees (45%) with RK models.
4. Do not operate the mower under any conditions where traction or stability is in question. Always be sure of the mowing surface. A tip or overturn could cause serious personal injury or property damage.
5. Stay at least 4 feet (1.2 meter) from drop-offs, ditches, embankments or the edge of water to help ensure the mower does not get out of the mowing zone. You could damage the mower or cause a serious injury.

I. Maintenance and Special Instructions







1. Keep the mower in good working order. Replace worn, damaged or broken parts.
2. To avoid serious injury do not modify the mower in any way.
3. Non-O.E.M. blades might not fit properly or could be inferior quality and a safety concern.
4. Always remove the disabling key first before servicing or inspection.
5. The blade should come to a complete stop within two (2) seconds after pressing the red stop control. If you do not hear the blade stop in less than two (2) seconds, your mower must be serviced professionally by an authorized service dealer.
6. Never use a high pressure power washer or hose to clean the mower. Water can damage components and the programmable controller. Use a damp cloth to wipe the display clean.
7. Visually inspect blade for damage (e.g., excessive wear, bent, cracked). Replace the blade with the original equipment manufacturer's (O.E.M.) blade only. Non-O.E.M. blades will not fit properly.
8. Use of service parts which do not meet the original equipment specifications may lead to improper performance and compromise safety.

9. After striking a foreign object, or getting hung up, stop the mower, remove disabling key and switch off the mower. Thoroughly inspect the mower for any damage. Repair the damage before starting and operating.
10. For areas close to a children's play area, bodies of water, drop offs or public roads, supplement the perimeter wire with a rigid (wood/stone) boundary edge at least 15 cm (6 inches) high which will help prevent the mower from exiting the mowing zone.
11. Clean or replace safety and instruction labels, as necessary.

J. Product End of Use

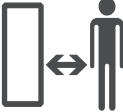
1. The mower and its accessories should be properly disposed of at the end of their useful life to prevent waste electrical and electronic equipment from ending up in landfill sites, and to protect and improve the quality of the environment. Check with your local trash facility or municipality regarding disposal laws. Many municipalities provide special waste collection sites for the disposal of batteries and electronic equipment.
2. Do not dispose of the Battery Pack or the mower in unsorted municipal/household trash.
3. Do not dispose of the Battery Pack in a fire.
4. See local and state regulations for any special disposal or recycling laws and requirements. Refer to end of the Quick Reference section for disposal instructions.

2 Symbols Definitions on the Mower

Symbol	Description
	<p>WARNING — READ THE OPERATOR'S MANUAL(S)</p> <p>Read, understand and follow all the safety rules and instructions in the manual(s) and on the mower before attempting to operate this mower. Failure to comply with this information may result in personal injury or death. Keep this manual in a safe location for future and regular reference.</p>
	<p>DANGER — AVOID AMPUTATION INJURY</p> <p>Do not put hands or feet near or under the cutting deck. Contact with the blade can amputate hands and feet.</p>
	<p>WARNING — AVOID CRASH/BLADE INJURY. KEEP A SAFE DISTANCE FROM THE MACHINE WHEN OPERATING.</p> <p>Do not mow when children or others are around. To help avoid blade contact or a thrown object injury keep others away from the mower while it is in operation. Keep bystanders, children and pets inside while the mower is in operation. Stop mower if anyone enters the area.</p>
	<p>WARNING — AVOID THROWN OBJECT INJURY</p> <p>Keep helpers at least 15' (5 meters) from mower during operation. Remove all stones, sticks, wire, bones, toys and other foreign objects which could be picked up and thrown by the blade(s). Do not operate the mower without the entire cover or guards in their proper place.</p>
	<p>WARNING — AVOID CRASH/BLADE INJURY</p> <p>Do not allow children to ride on the mower. It is not a toy.</p>
	<p>WARNING</p> <p>Shut off the mower before attempting to service it.</p>
	<p>WARNING</p> <p>Remove the disabling key before working on or lifting the machine</p>

3 Safety Features



WARNING!

Your mower is equipped with numerous built-in safety features. However, the mower is a hazardous device with a sharp blade, which can cause major injury to anyone who comes in contact with it.

Therefore, it is absolutely forbidden to be on the lawn while the mower is working.

A. Child Lock

The Child Lock prevents unintended operation of the mower by an accidental press of one of the buttons. Only pressing two buttons in the right order will initiate the operation. It is required to activate the Child Lock feature if children under age 6 may come in contact with the mower.

B. Anti-Theft

The Anti-Theft Device system function will prevent anyone from using or driving the mower unless they have a valid code to enter. You will be prompted to enter a four digit code of your choice to use as your personal security code (for models RT it is available using mobile app only). It is highly recommended to activate this feature to prevent operation of the mower by children or people who are unfamiliar with the mower or not allowed to use it.

A. Lift Sensor

If the mower is manually lifted off the ground, the mower and rotation of the blade will stop in two (2) seconds.

B. Tilt Sensor

If the mower is tilted up towards a vertical position, the mower and rotation of the blade will stop in two (2) seconds.

C. Obstruction Sensor

Your mower detects interfering obstacles in its way during operation. When the mower collides with an obstacle it will stop movement in that direction, reverse itself away from the obstacle and the mower and rotation of the blade will stop in two (2) seconds.

D. Quick Stop Control

Pressing down (RK and RT models) and/or pulling up (RK models) the red STOP control at any time during operation will stop the mower and the blade in (2) two seconds.

E. Removable Disabling Key

Pulling out the disabling key will prevent any operation of the mower. It is required to pull the disabling key before lifting the mower and before any maintenance is done.

F. Base Station/Perimeter Switch and Perimeter Wire

The mower cannot operate without a Perimeter Wire installed and activated through the Base Station/Perimeter Switch. In the event the Perimeter Wire signal is turned off, the mower will stop operating.

**Let's get
started.
Can't wait
to mow
your lawn.**



Welcome to a friendly home

Congratulations on your purchase! You are just a few steps away from meeting your best team player. Very soon you will come to count on your new friend to do a perfect job.

It will automatically depart from its Base Station on predetermined days and times, mow your lawn and return its Base Station for charging.

A pre-installed perimeter wire sets the boundaries (a “virtual wall”) for your mower. It will be laid around the edges of your lawn and objects that you want to protect.

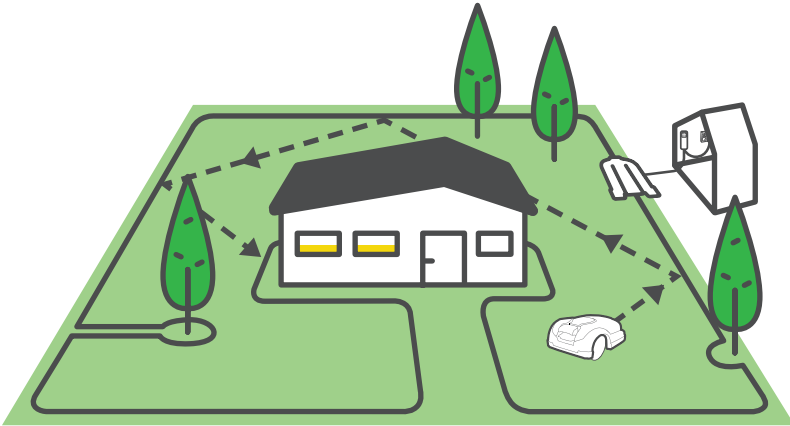

The mower moves randomly within its working area, as defined by the perimeter wire. This kind of random movement provides the perfect cut and ensures complete coverage of your lawn.

In addition, it follows the perimeter wire when it mows the edges of your lawn to give it a perfect finish.

Good-looking lawns are achieved by consistent mowing, which is exactly what your Robomow provides.

After following the installation instructions, you will be ready to enjoy your free time, while your new friend looks after your lawn.

It is highly recommended to read the complete installation guide prior to installation.

What's in the Box

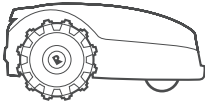

The product

Your new Robotic Mower

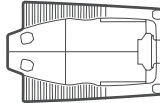

Base Station

This is where the mower recharges itself

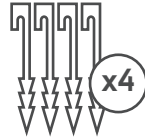

Base Station Stakes

For affixing the Base Station to the ground



Perimeter Wire*

Marks the working area for the mower

(*) Not included in all models



Power Supply

The power supply for charging your mower



Extension Cable

15 m (50v ft) low voltage cable to connect the mower to the Power Supply unit



Wire Pegs*

For securing the wire to the ground

(*) Not included in all models

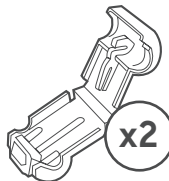

Spare Plot Connector

For connecting the Perimeter Wire to the Base Station

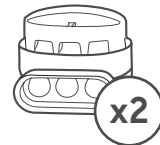

Wire Connectors

For splicing the Perimeter Wire in case of a cut



Safety Guide
Getting started guide

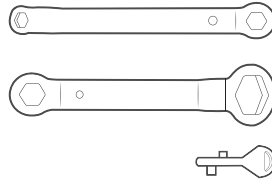

Tools

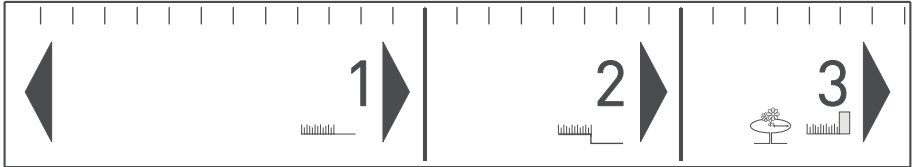

RoboRuler

For measuring the Perimeter Wire's distance from the lawn's edge



Tools required for installation

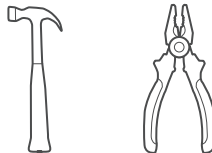

Ready? Let's begin...

So where are we heading?

Correct installation of your mower will ensure maximum results. This is what it takes to prepare it to do a perfect job for you:

Base Station location

Choose Base Station location

1

Lay the wire

Lay out the “virtual boundary”

2

Soft Obstacles

How to protect soft obstacles

3

Hard Obstacles

When should they be excluded

4

Slopes

What slopes can the mower handle

5

Narrow pass

How to wire a Sub-zone

6

Separated zone

How to wire a separated zone

7

Finish

Complete the installation

8

Know Your Lawn

Understanding your lawn will save you unnecessary mistakes and make the installation process easier and more straightforward.

You can also skip some later sections in this manual that are not relevant to your lawn type.

So, what does your lawn look like?

Type A Main Zone only

Your lawn area is one continuous zone and all areas of the lawn are wide enough for the mower to navigate through (at least 4 m (14 ft) wide at its narrowest point).

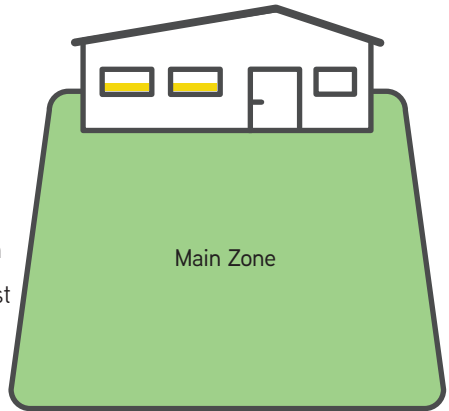

Type B Main Zone + Sub Zone

Your lawn consists of more than one zone. These zones are connected by a narrow passage 1-2 m (3-6ft). The mower can drive between these zones to mow the entire area.

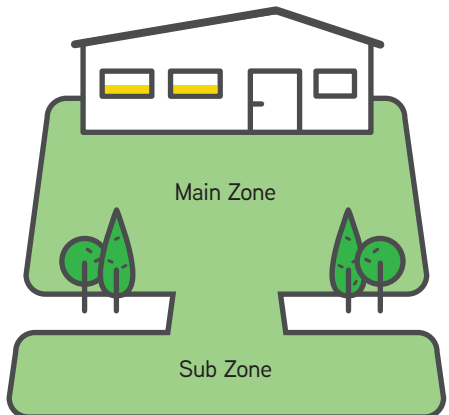

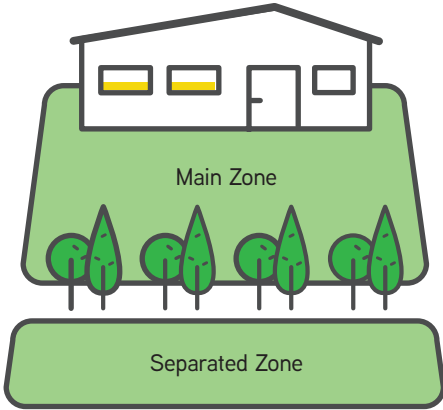

Type C

Main Zone + Separated Zone

Your lawn consists of two or more zones that are not connected (separated by a fence, sidewalk, pathway or other obstacle). The mower cannot drive between these zones.

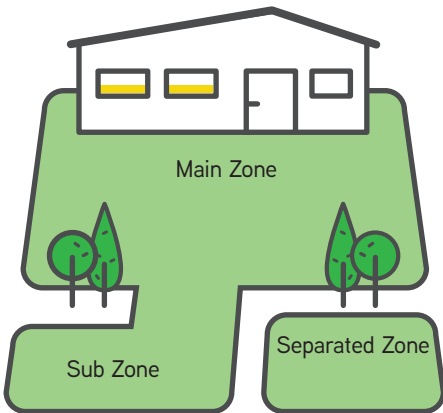

Type D

Main Zone + Sub Zone + Separated Zone

Some areas of your lawn are connected to the Main Zone by a narrow pass (up to 1-2 m (3-6ft wide) and some areas are totally separated from the Main Zone by a fence, sidewalk, pathway or other obstacle, and the mower can't drive between them.

1 Base Station Location

Choose locations for the Base Station & Power Supply unit

The Base Station is where your mower recharges and where the perimeter wire starts and ends. In this installation step, you are going to determine a proper location for the Base Station.

Where should you place your Base Station?

Consideration A

It is strongly recommended to place the Base Station in the Main (largest) zone of your lawn

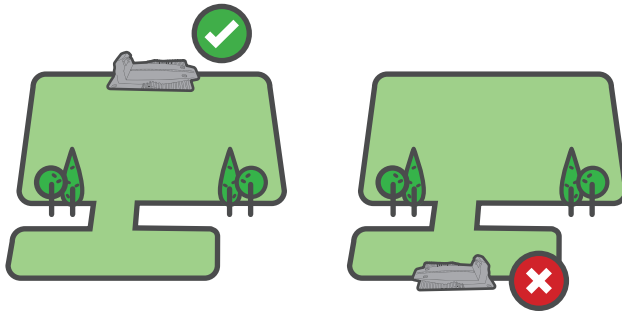

Consideration B

Up to a max. of 15 m (50 ft) from a power outlet

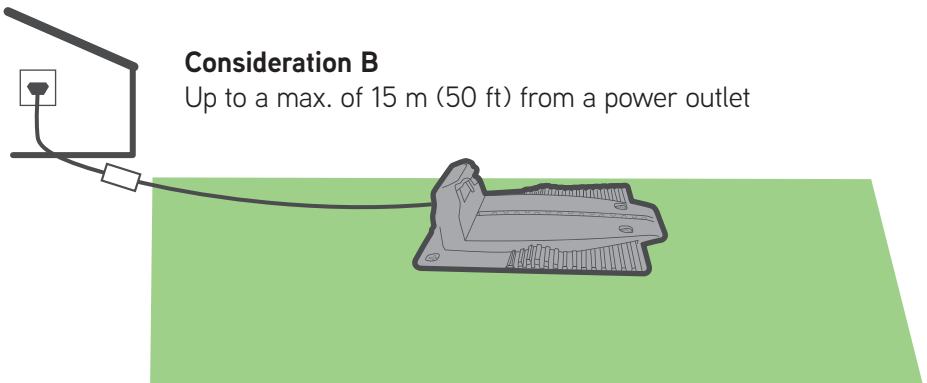

Consideration C

A minimum of 3 m (10 ft) of straight wire in front of the Base Station and a min. of 1 m (3 ft) behind the Base Station to allow smooth docking

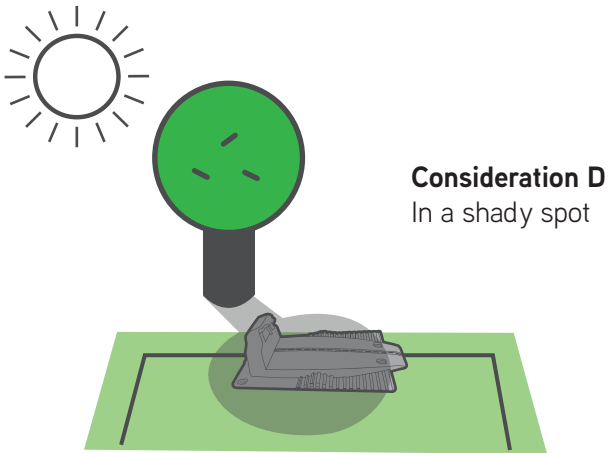
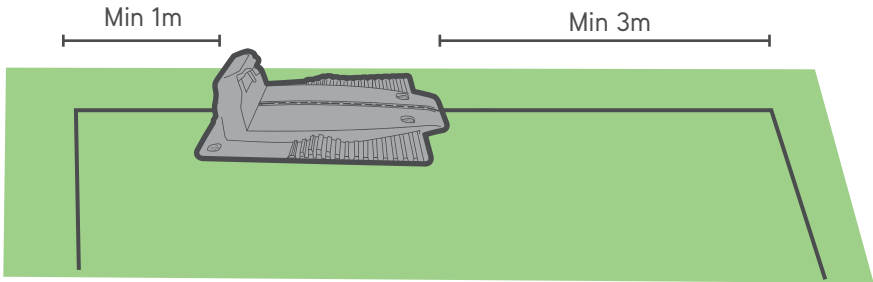

TIPS

- Keep a minimum of 1 meter (3.3 ft) from a sprinkler head to avoid damaging the mower's internal components

Consideration E

Make sure the ground is even and flat, and that there is no slope



How to install the Base Station?

ORIENTATION

Place the Base Station according to the image below

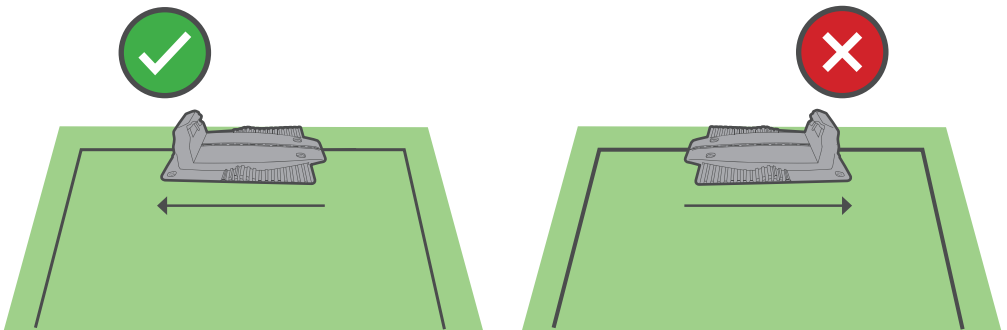

DISTANCE FROM EDGE

Use the ruler to install the wire in the correct distance from the edge of your lawn.

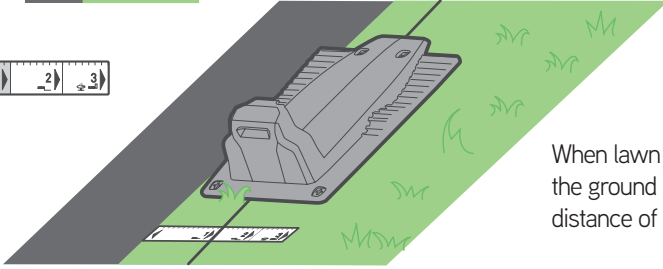

When lawn is level with the ground use 1st distance of the ruler

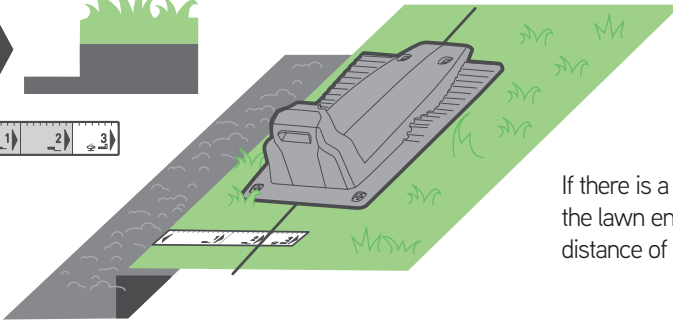

If there is a drop where the lawn ends use the 2nd distance of the ruler

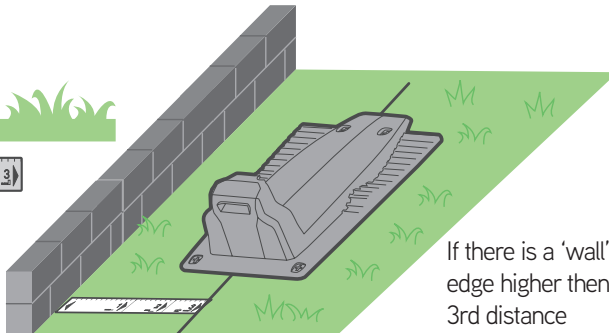

If there is a 'wall' on the lawn edge higher than 5cm please use 3rd distance

PEG BASE

After choosing the proper location, Secure the base station to the ground using the provided pegs

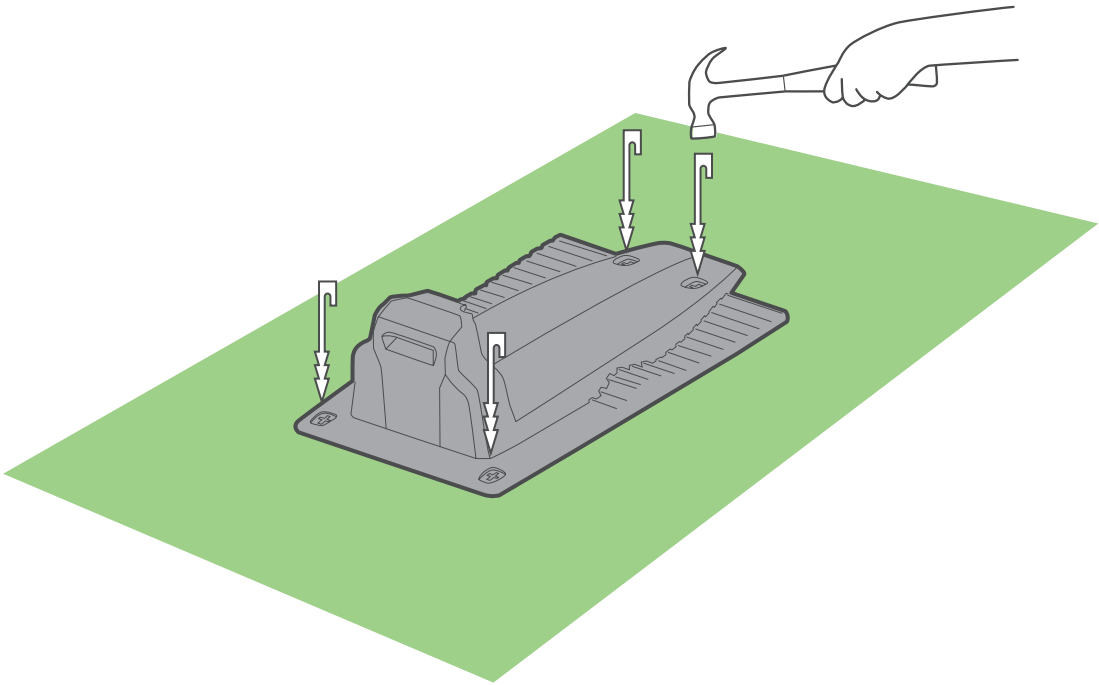

Be careful not to damage irrigation pipes when hammering down the stakes.



Plan Ahead

Before you begin, walk along the edge of your lawn and plan how to set up the Perimeter Wire. Take note of all obstacles and slopes.

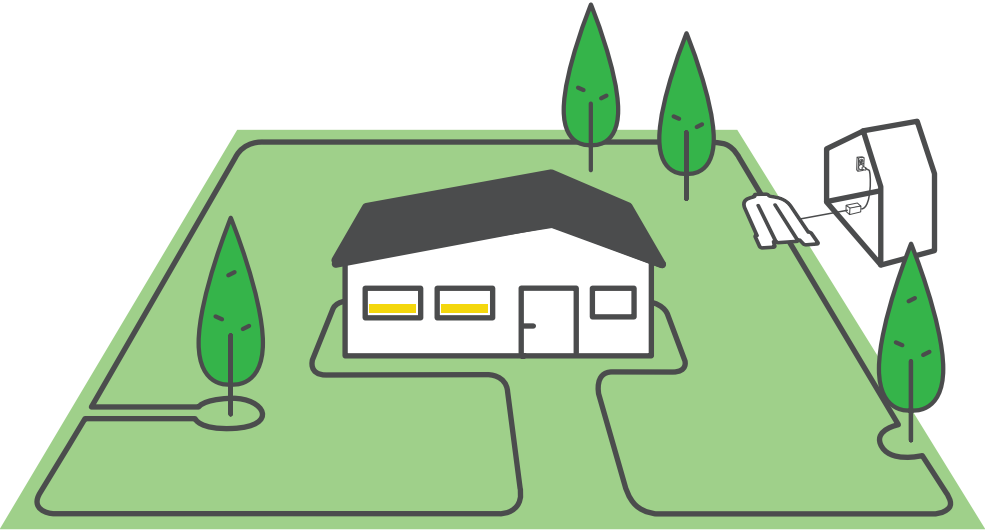

Obstacles and Slopes

Before you put a single peg into the ground, take note of any obstacles or slopes.

OBSTACLES



Soft Obstacles

Soft obstacles are flower beds, ponds or small trees. They need to be protected by creating Perimeter Islands.

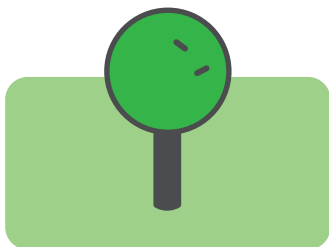

Hard Obstacles

Hard obstacles are vertical, rigid and higher than 15 cm (6 in), such as trees or large hard elements that the mower can gently bump into without damaging

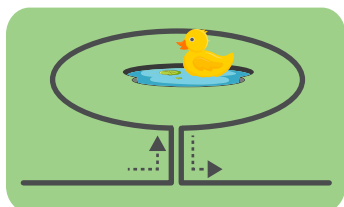

Ponds

Ponds and other bodies of water need to be protected by creating Perimeter Islands.

SLOPES

Slopes along the edge

To ensure your mower doesn't slip off the lawn, especially when the grass is wet, the Perimeter Wire must exclude a slope along the edge of your lawn with an incline of over 20% - that is, 20 cm rise per 1 m [8 in rise per 3 ft].

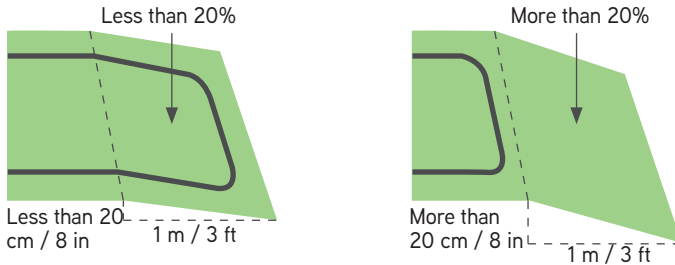

Slopes within the Lawn

Your mower can mow areas within the lawn with a slope of up to 45%. You can include slopes near the edge if the slope is towards the outside of the lawn, hence there is no risk for your mower to slip outside the lawn. A 45% slope means 45 cm rise per 1 m (17 in rise per 3 ft).

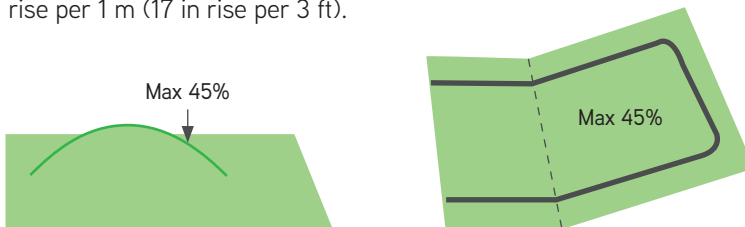

The slope is too steep if...

The mower tilts off the ground while climbing it. Exclude such slopes from the cutting area.



TIP

2 Lay the Wire

Lay the perimeter wire (“virtual boundary”), which defines the working area for the mower.

Now you’re ready to install the Perimeter Wire. Let’s take it step by step.



TIPS

- Have your mower’s package nearby.
- Be sure to cut your grass with your old mower one last time before you start wiring. In addition, the ground should be moist. This will make inserting pegs easier and help ensure that the mower doesn’t cut the wire.



WHAT YOU’LL NEED

- Hammer
- Combination pliers



... A sunny day and a sunny mood :)

Let's make a good start

Pull out approx. 50 cm (1.6 ft) of wire and peg the beginning of the wire to the ground where you intend to install your Base Station.

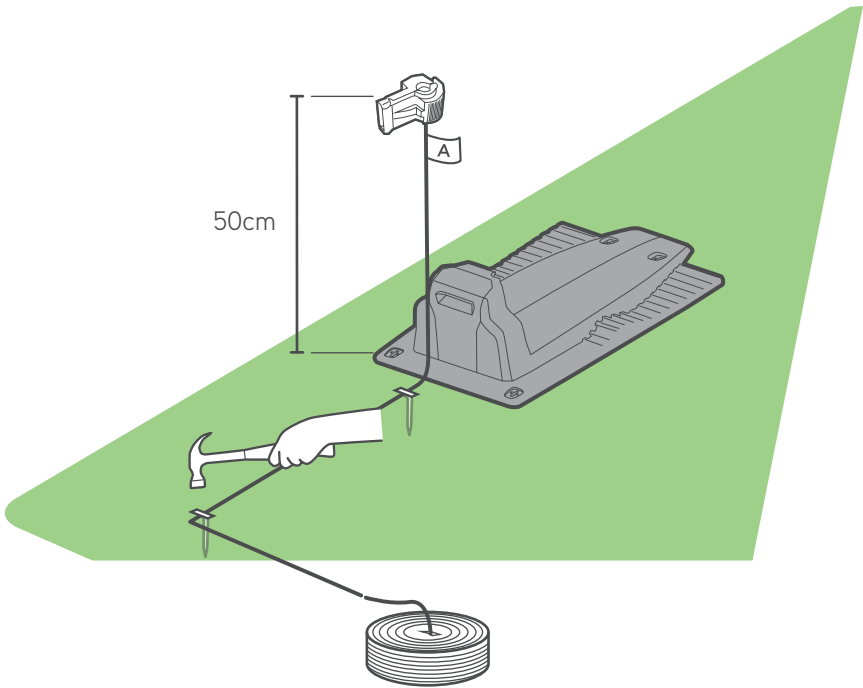

Start unwinding the wire counter-clockwise around the lawn, starting at the Base Station's location.

Lay it loosely along the perimeter as you walk along the lawn edge. If you get to any area/object that needs special care, make sure you carefully lay the Perimeter Wire as described in the following sections.

Maintain Proper Distance

The Perimeter Wire is secured to the ground by the pegs supplied with the product. Use the RoboRuler to determine the distances you should leave between the Perimeter Wire and the lawn's edge and obstacles.

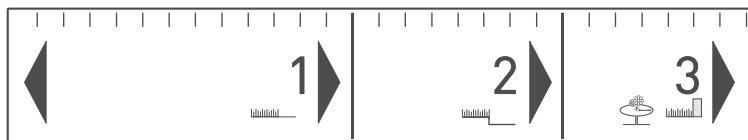
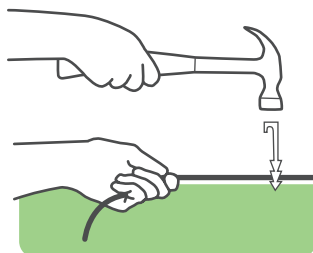

- Insert pegs every 2-3m/7-10ft and at corners. At this early stage, set a minimal number of pegs. You will insert all necessary pegs later.
- Pull the wire tight while hammering the pegs to their final depth in the ground.
- Take care not to damage irrigation pipes.

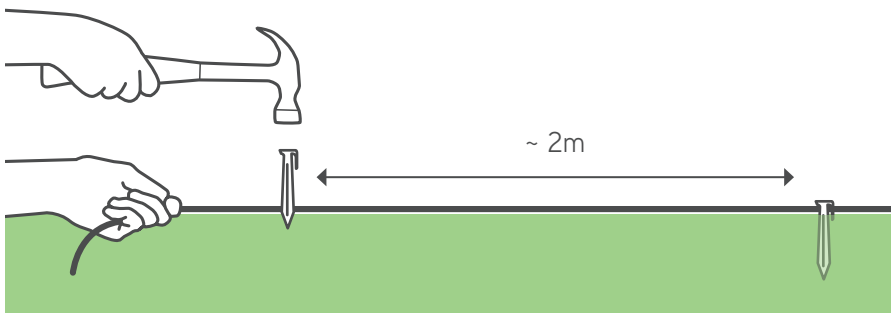

When the edge is flat, use the short distance of the RoboRuler.

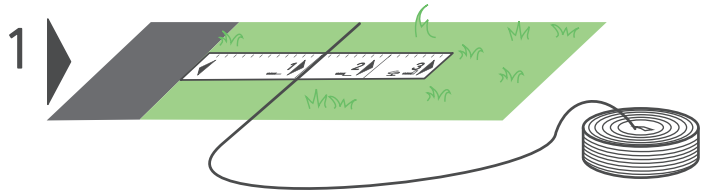

When the edge is a drop, use distance 2 of the ruler

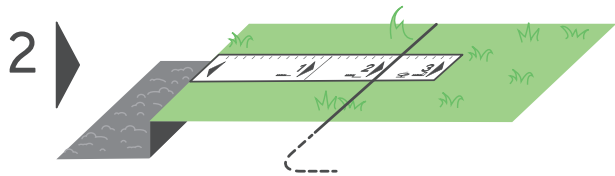

When the edge is a wall (more than 2 cm/1" above the ground level), use the 3rd distance of the RoboRuler.

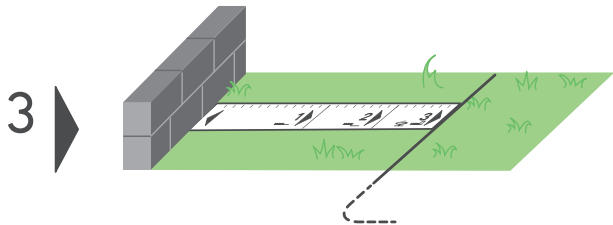

Leave a minimum of 1.2 m (4 ft) if the edge of the lawn borders water.

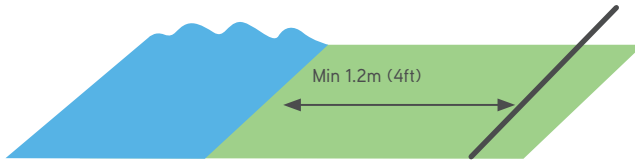

Alternatively, place a physical barrier close to the water.

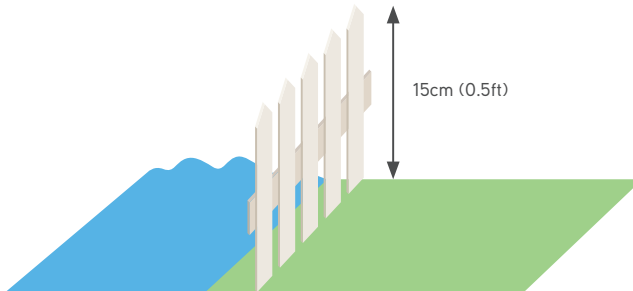

TIPS

- It is not necessary to bury the Perimeter Wire.
- Burying the wire along exposed areas, such as pavements, is usually recommended.
- If additional Perimeter Wire is required in order to complete the setup, you can extend it using the waterproof Wire Connectors provided (see page 56 “Splicing the Perimeter Wire”).

3 Soft Obstacles

Protect Soft Obstacles

Objects such as flower beds, ponds, or small trees must be protected by setting Perimeter Islands.

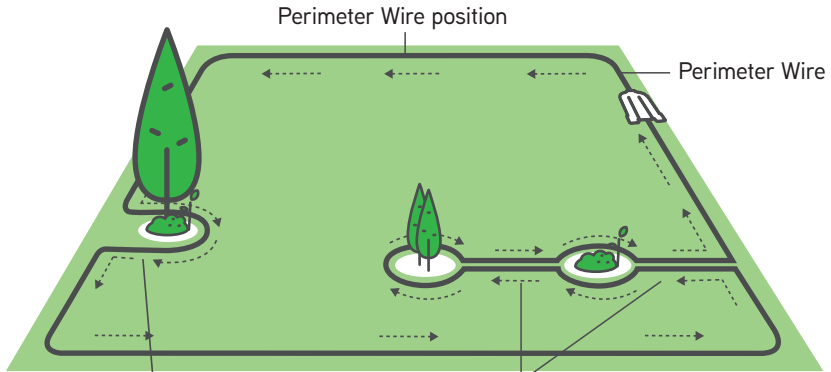

If the distance between an island and the perimeter wire is lower than 1.2m (4 ft), make the obstacle part of lawn's edge.

Keep min. 1.2 m (4 ft) between islands; if obstacles are closer together, use one island.

Set the Perimeter Wire clockwise around the obstacle, otherwise the mower will drive into the Perimeter Island or won't be able to mow the area around it properly.

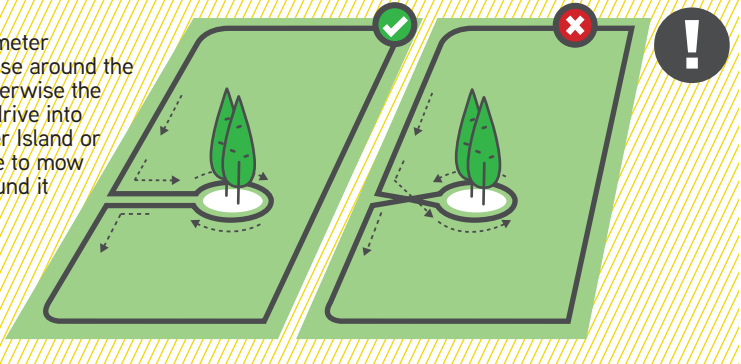

- Wires leading to and from an island should be fastened with the same peg



TIPS

4 Hard Obstacles

Protect Hard Obstacles

Exclude from the lawn any hard objects that are lower than 15cm. Higher hard objects can be left unprotected inside the lawn

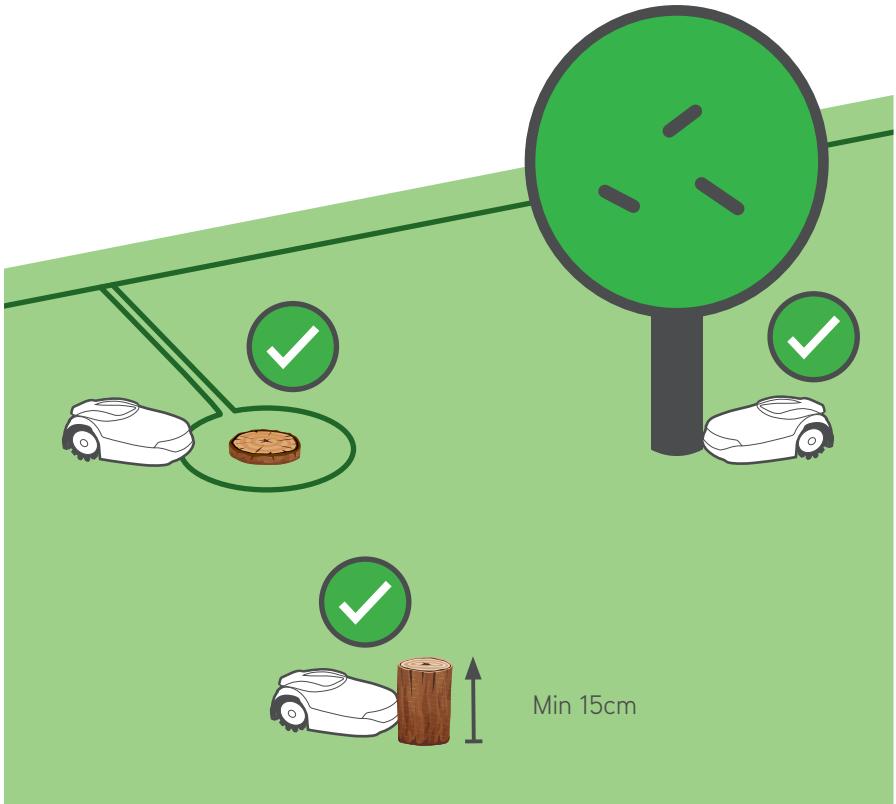

5 Slopes

Slopes

Your mower can handle any slope up to 45% inside the lawn

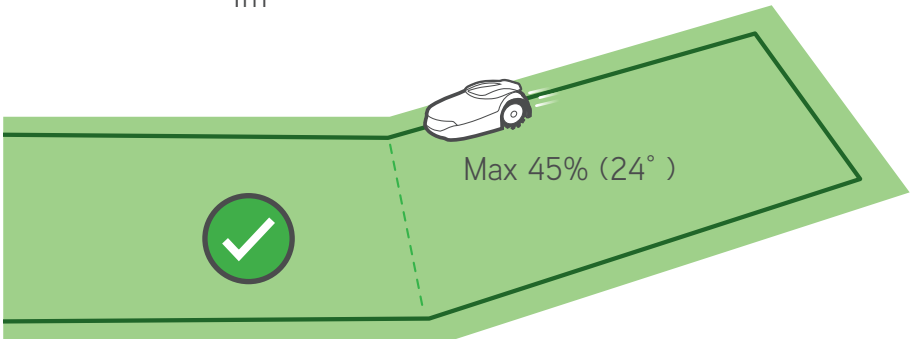
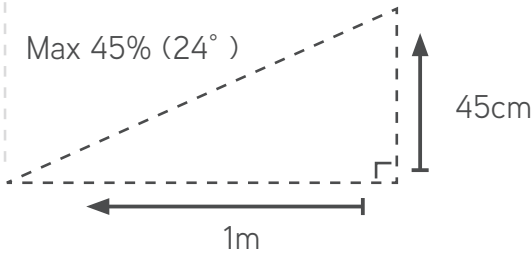
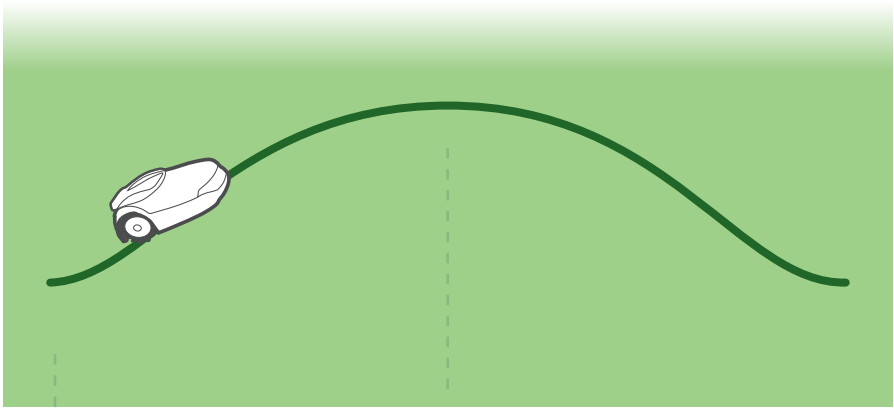

Exclude any slope greater than 20% that are on the edge of your lawn to prevent the mower from slipping outside your lawn (especially in wet conditions)

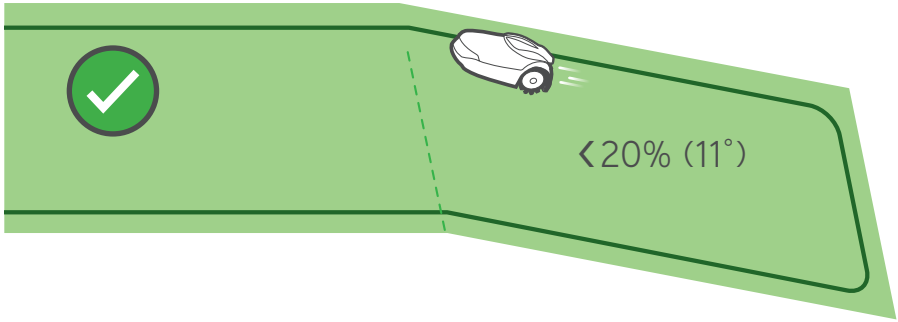

20% =

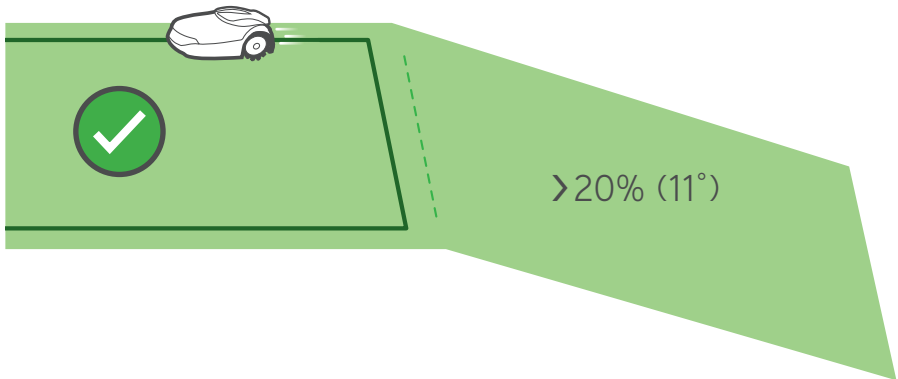
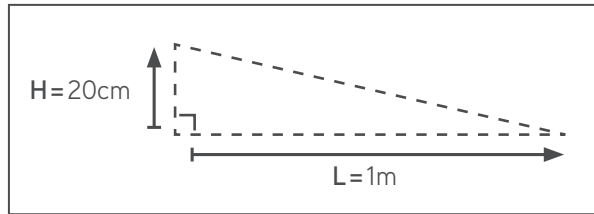

6 Narrow Pass

Recall Your Lawn Type

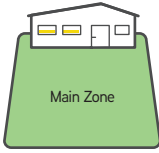

Type A
Main Zone only

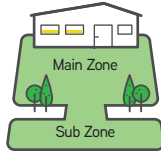

Type B
Main Zone +
Sub Zone

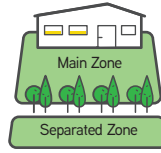

Type C
Main Zone +
Separated Zone

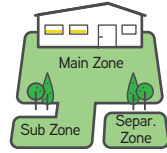

Type D
Main Zone +
Sub Zone +
Separated Zone

How to Wire a Sub Zone

Type B / Type D

Don't have a Sub Zone?
Skip this section!

A Narrow Pass connects the Main Zone with a Sub Zone. To allow your mower to drive through, it should be at least 2 m (6ft) wide.

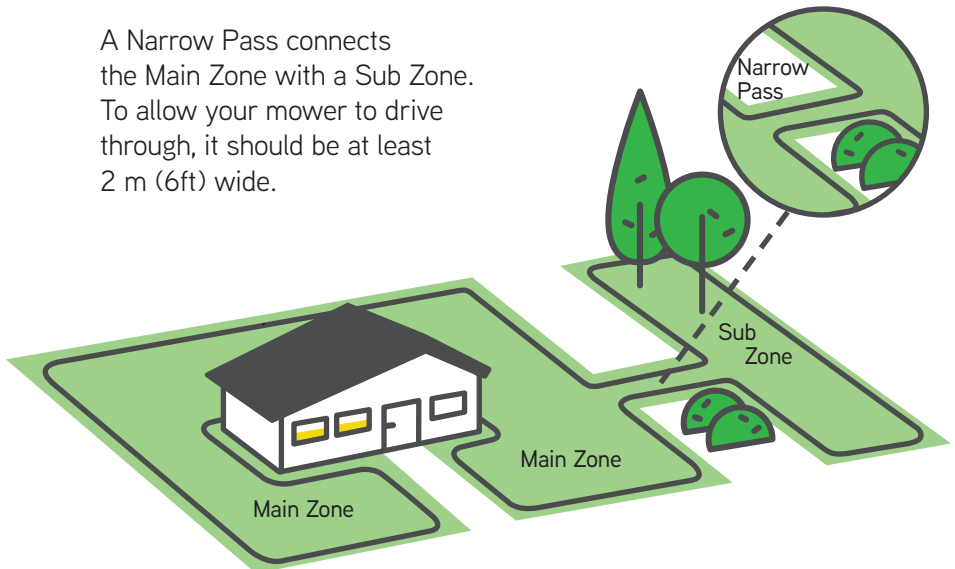

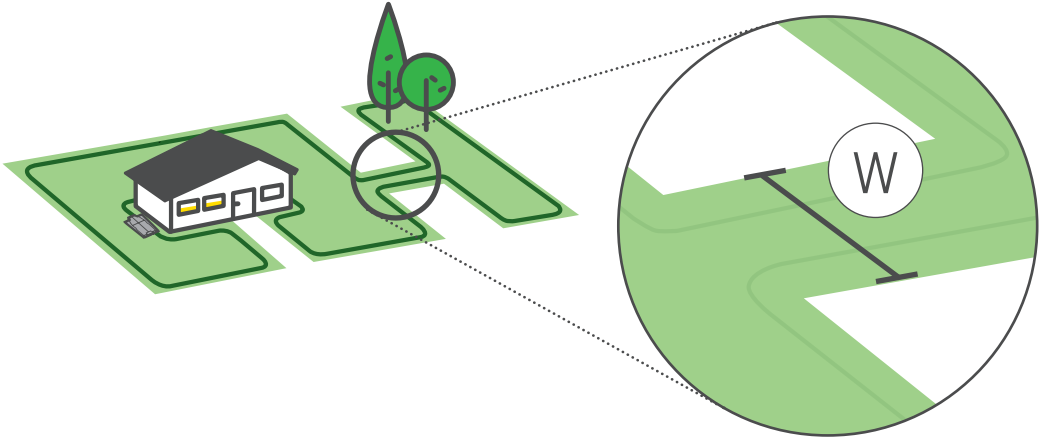

A Narrow Pass connects the Main Zone with a Sub Zone.
For passages greater than 2m (6.5 ft), the mower will be able to drive through.

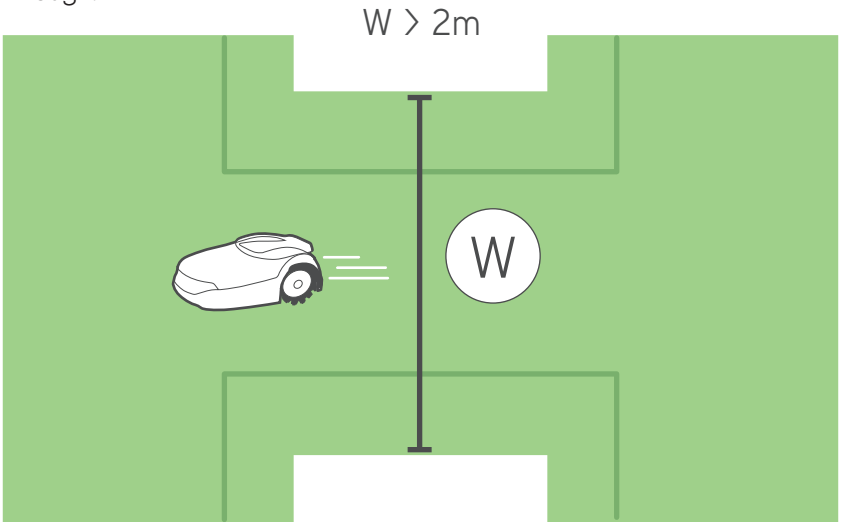

When a narrow pass is between 1-2m (3-6ft), the wires should be installed the middle

of the path with Roboruler distance 1 between them. to allow the mower to be able follow the

wires in and out of the sub zone. on the entrance to the path from both directions, you should break the corner to 45 degrees so the mower will turn accurately in and out the sub zone

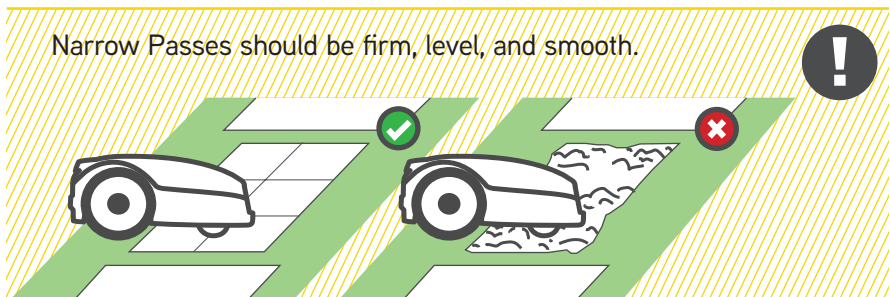
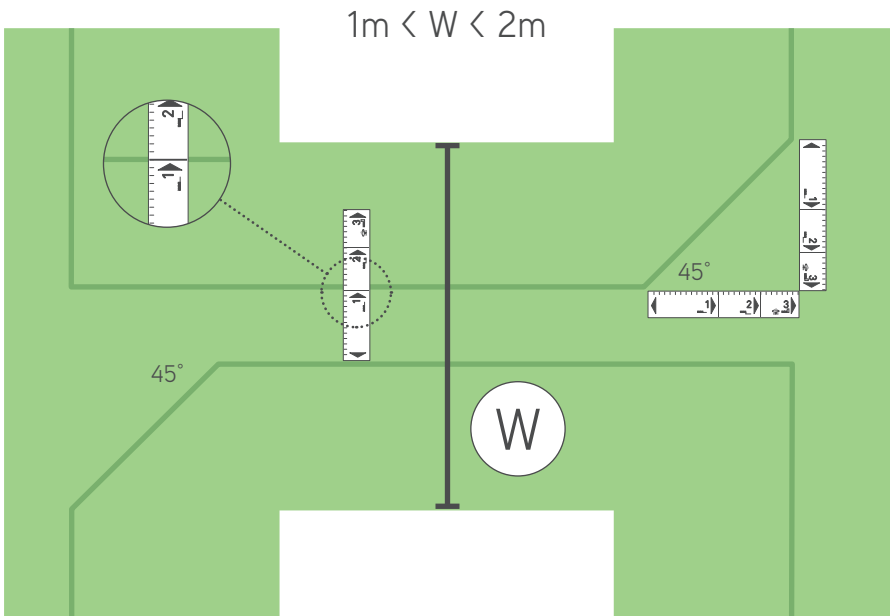

7 Separated Zone

F. How to Wire a Separated Zone

Type C / Type D

Don't have a Separated Zone?
Skip this section!

OPTION 1

Extend the Perimeter Wire from the Main Zone, over the obstacle.

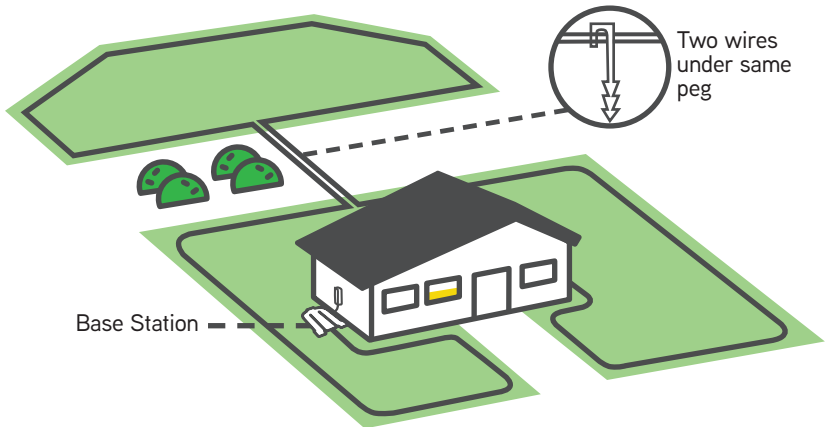

8

Complete the installation

G. Complete Wire Setup

Once the Perimeter Wire has been laid completely and you are back to the base station, install the last peg approx. 10cm (4 in) in front of the base. It is very important that the wire will be in-line with the base station.

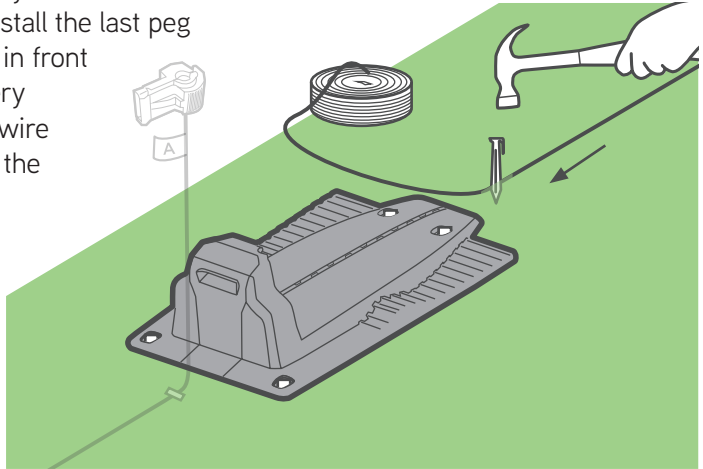

TIPS

Unwind the wire up to about 50 cm beyond the base station and cut it.

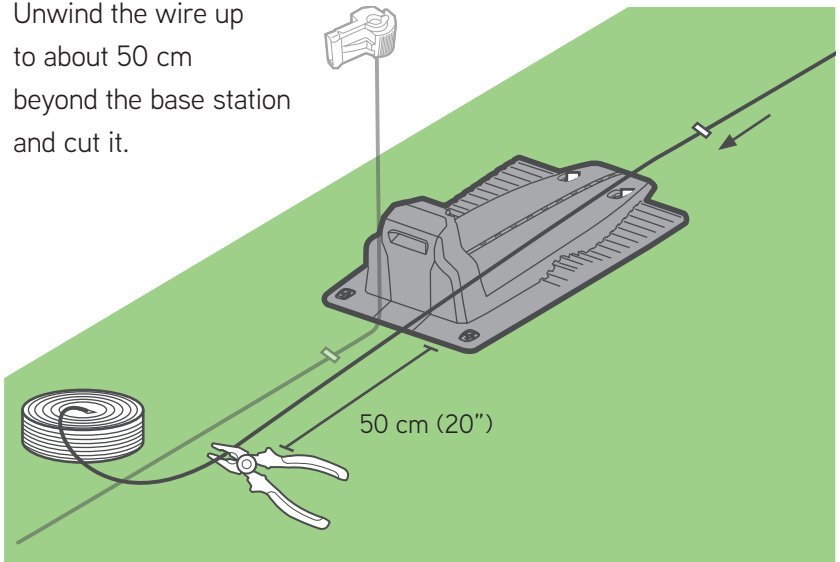

Open the back door of the base station.

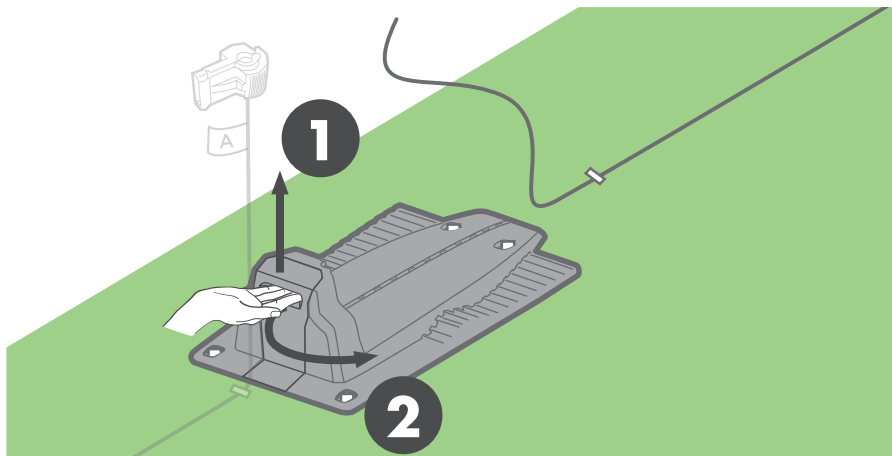

Slide or install the wire through the designated tunnel and pass it through the opening under the charging connectors until it goes out to the back of the base station

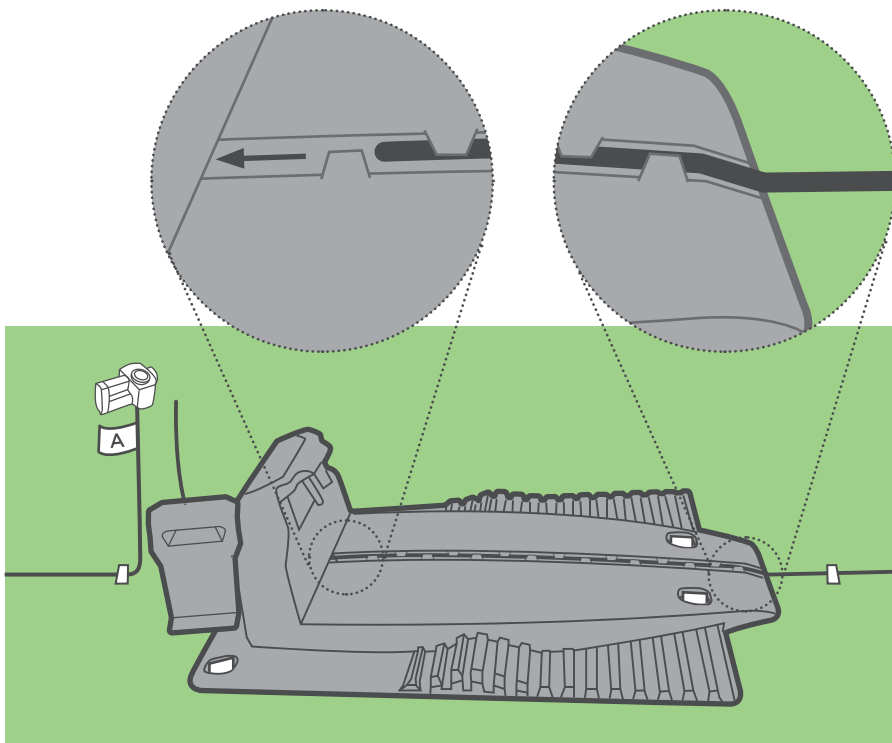

Install the connector to the tip of the wire as described in the drawings.

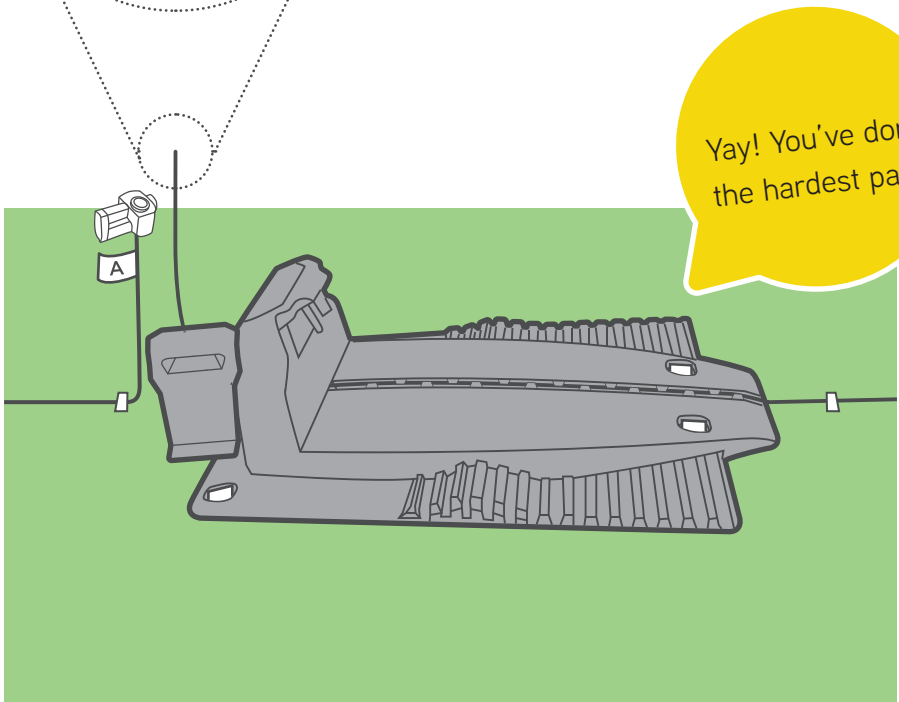
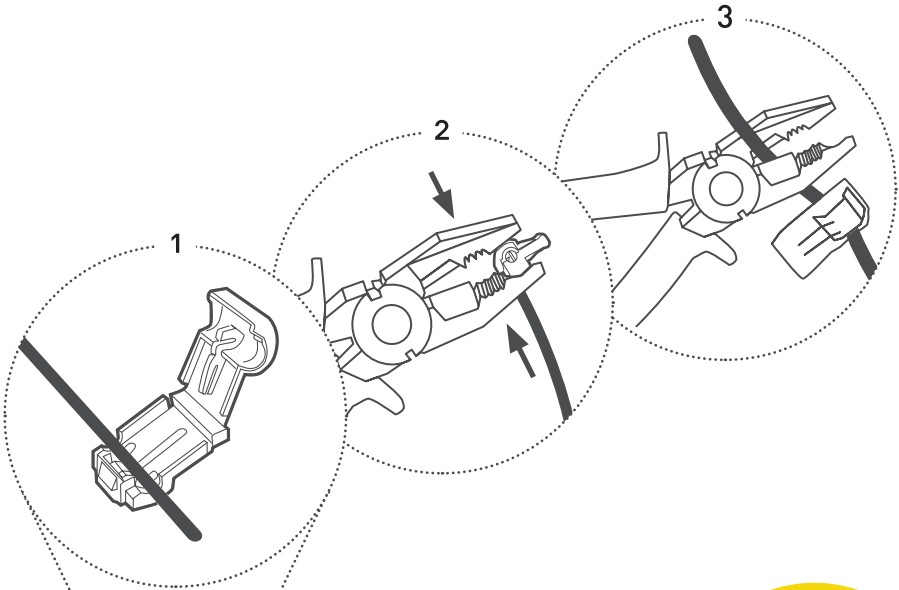

Yay! You've done the hardest part!

Peg the wire to the ground. twist the wires so they could fit nicely in base station compartment. connect the wire end marked with 'A' to the connector marked with A on the back of the base station. connect the other end to the other connector. tuck the wire in and close the door.

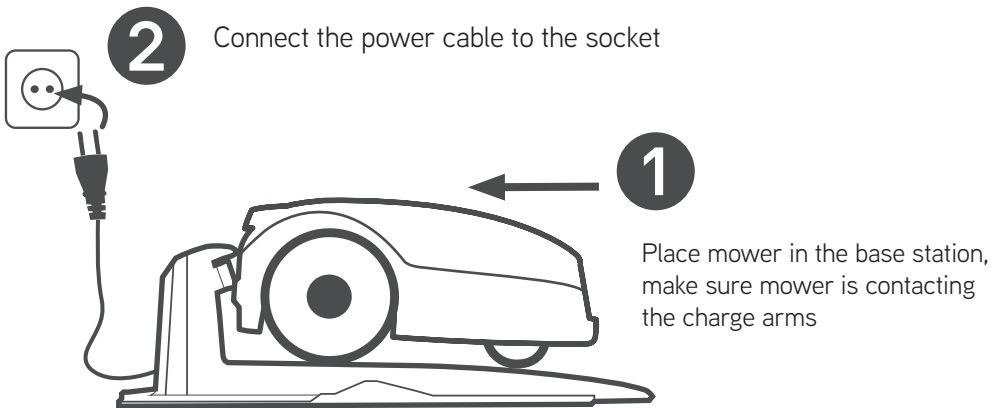
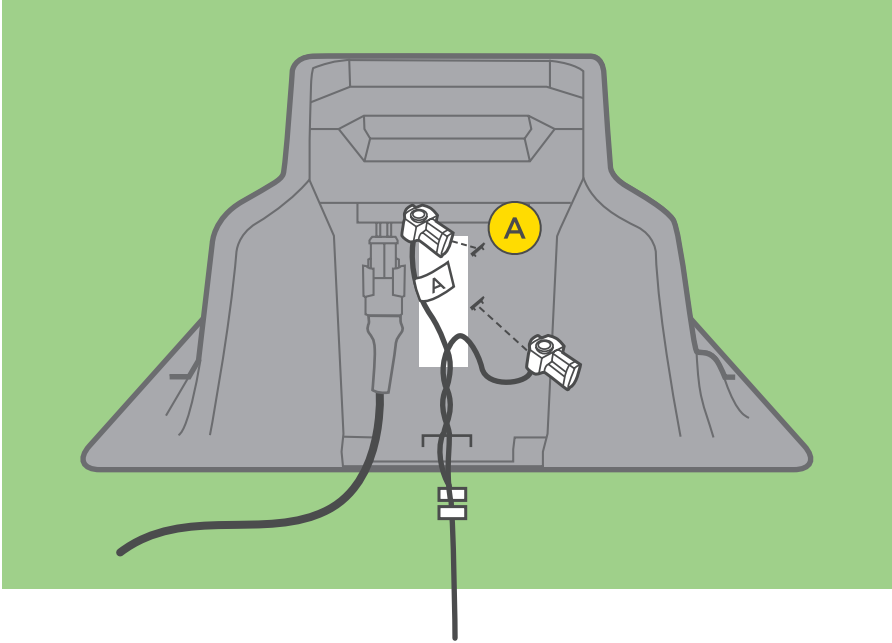

LED Indicators

Now you should see the LED indication on the Base Station blinking green (if the mower is outside the base station), or steady green (if the mower is inside the base).

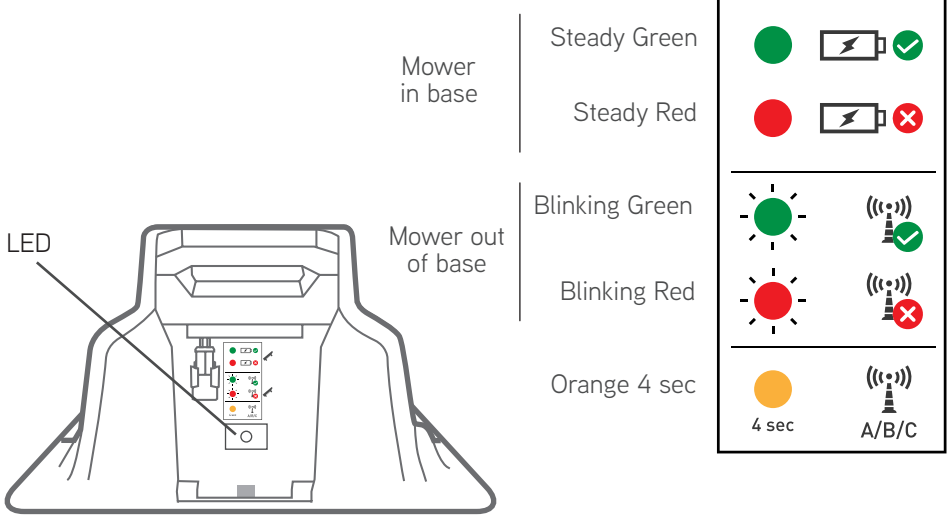

Caution

The Extension Cable from the Power Supply to the Base Station should be securely fastened to the ground! It should never present a tripping hazard.

The Extension Cable should cross ONLY over soft surfaces. It should not cross over hard surfaces (e.g., sidewalk, driveway) where it cannot be securely fastened.



Just one more
step to go...:)

One Time Setup

Turn the mower on and follow the initial settings to get it ready for work.

A. Set Language, Time and date

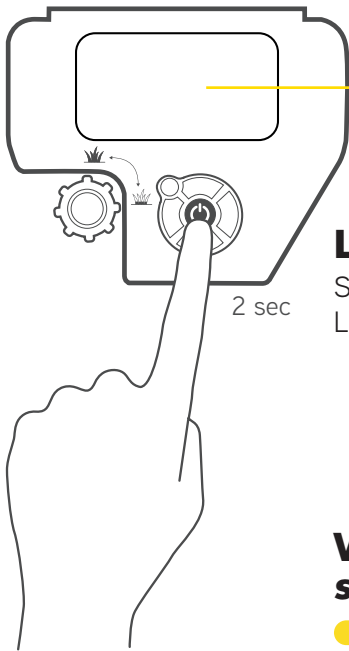

Language
Select your Language

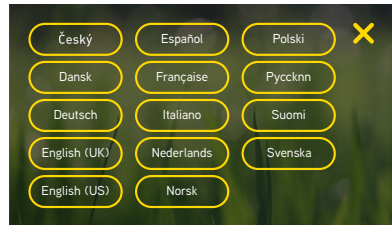

Welcome screen

→ Next

← Back

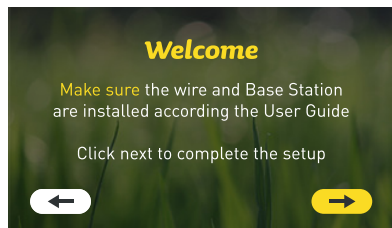

Date

Set date

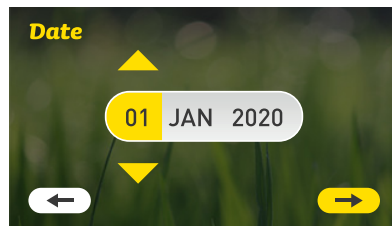

Time

Set time

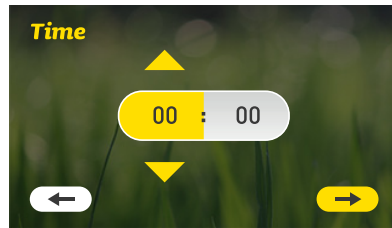

Installation done by...

Select who is performing the installation.

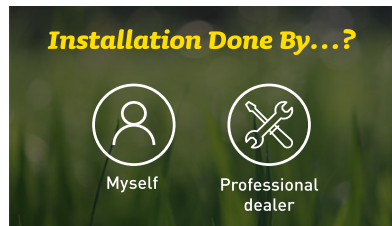

Set lawn size

Set your Main Zone area.



Set Cutting Height

You can set the cutting height by rotating the Knob right/left. Once done press next.

if the grass hi high, to get the best cutting results, it is recommended to lower the mowing height gradually over a couple of weeks.



Schedule Plan

the Mower calculates the suggested automatic mowing plan suited to your lawn according to its size. to start th automatic plan you need to approve it. you can choose to change it from this screen or come back to it later for adjustment. you can find the automatic scheduling plan settings under the settings (add icon) screen on your mower main screen.

you can read more information about the automatic plan settings options in the Automatic Operation' section in this manual.

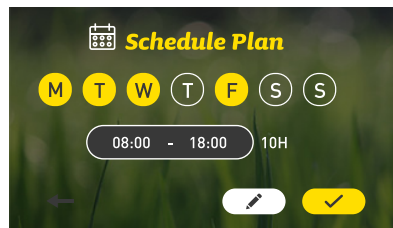

Secure wire

Now it's time to add some pegs along the wire.

Using the remaining pegs along the Perimeter Wire, approx. 1 m (3.3ft) apart.

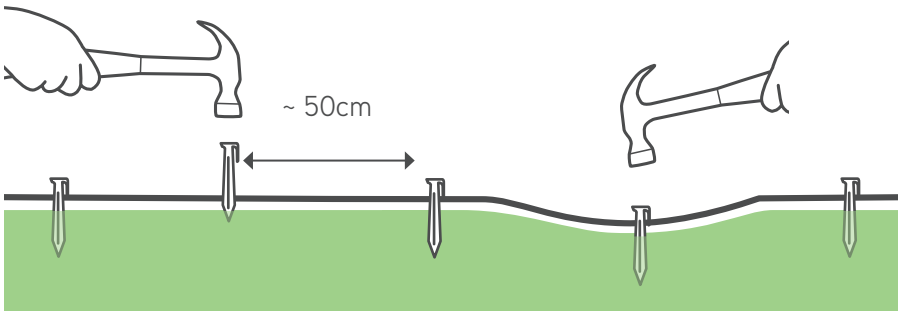

Splicing the Perimeter Wire (as needed)

- Insert both wire ends into the leftmost and rightmost positions on the connector.
- Verify that the wires are fully inserted into the connector.
- Use a pair of pliers to press the button on top of the connector. The button should be fully pressed, without damaging the connector.

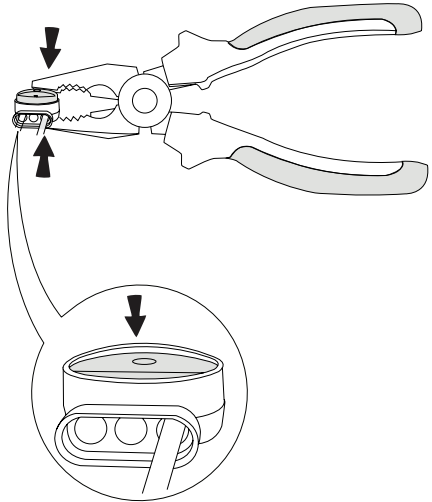
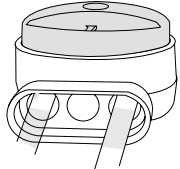

A decorative grid background with a yellow square in the upper right and grey squares in the top right, middle left, and bottom right.

Well Done!

Now relax, and let your
mower do the work.



- ① Knowing your mower**
- ② Menu structure**
- ③ Automatic operation**
- ④ Manual operation**
- ⑤ Features - how to**
- ⑥ Periodic maintenance**
- ⑦ Troubleshooting**
- ⑦ FAQs**

1

Knowing your mower

In order to fully enjoy your mower, learn about its different parts and messages. Understanding how it works and “interacts” will lead to its smooth and easy operation.

External Parts

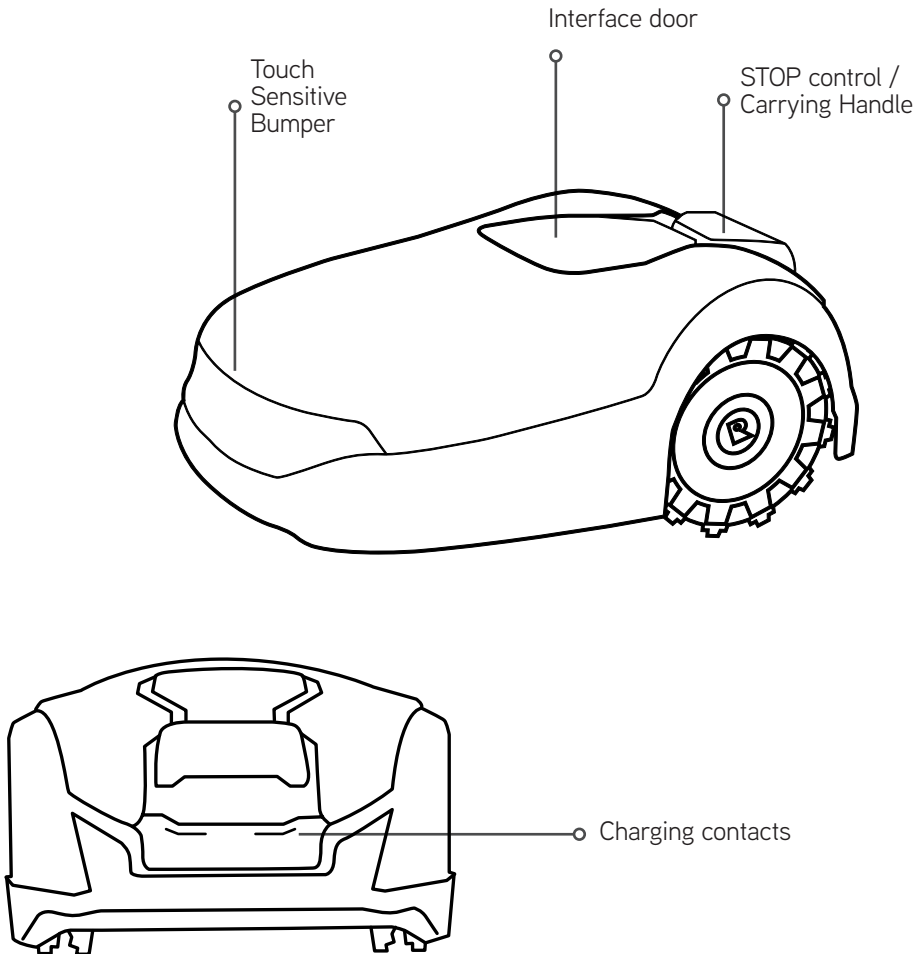

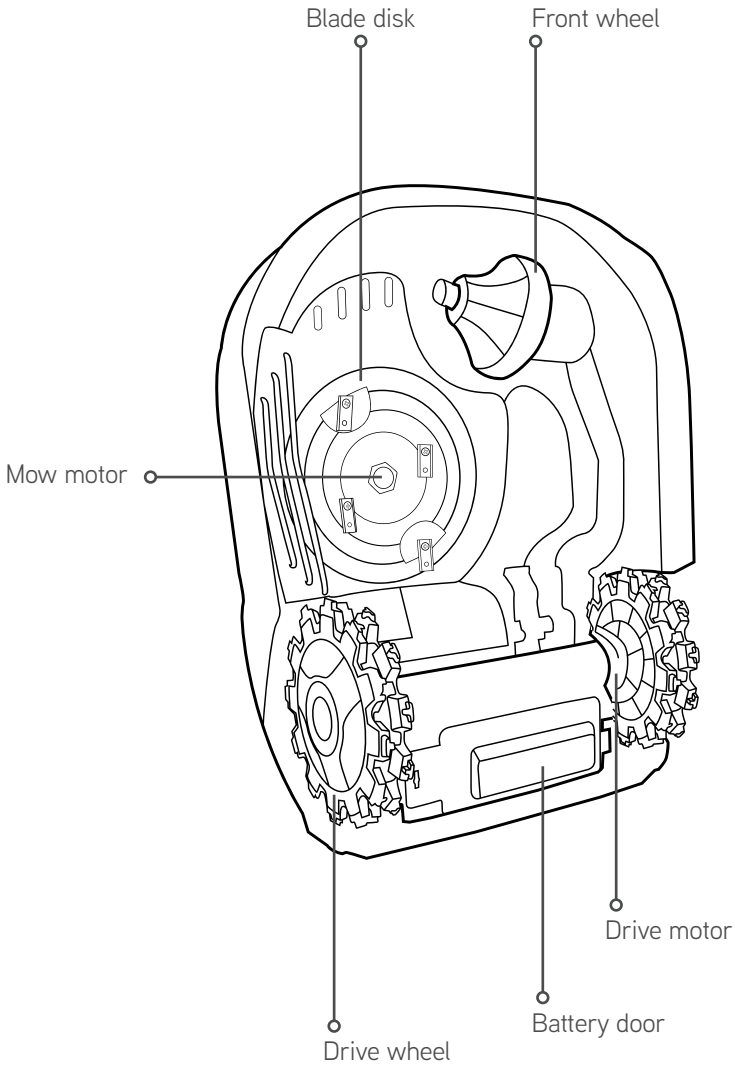

Under the Hood Parts

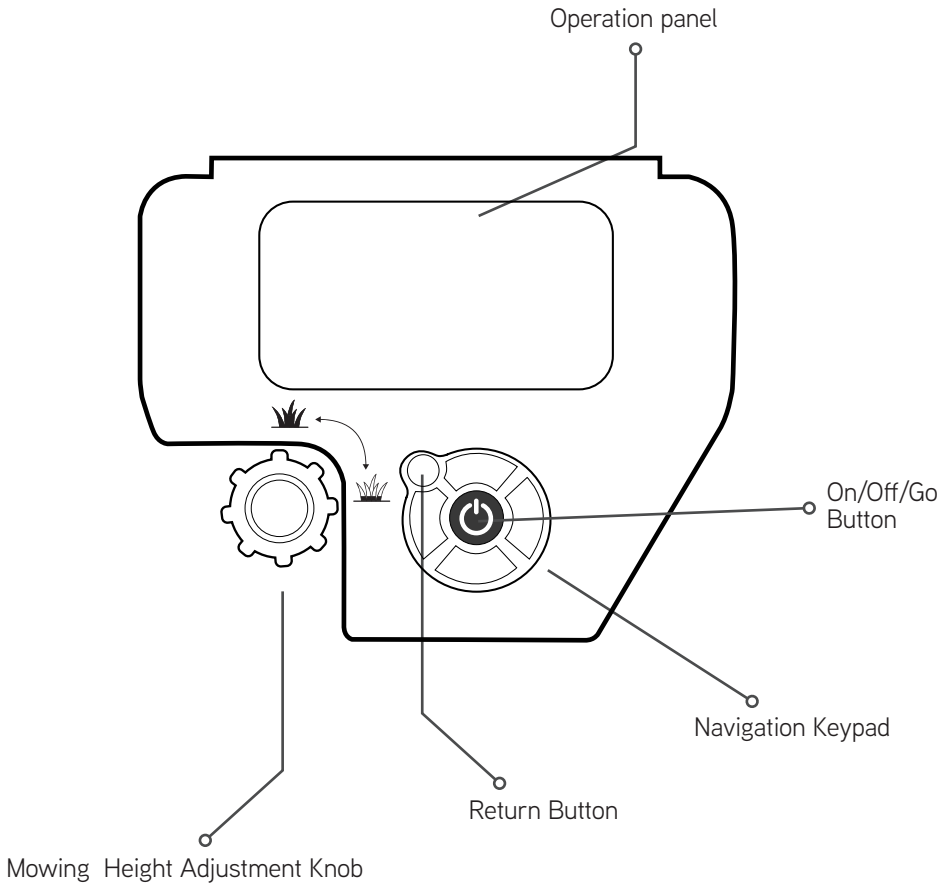



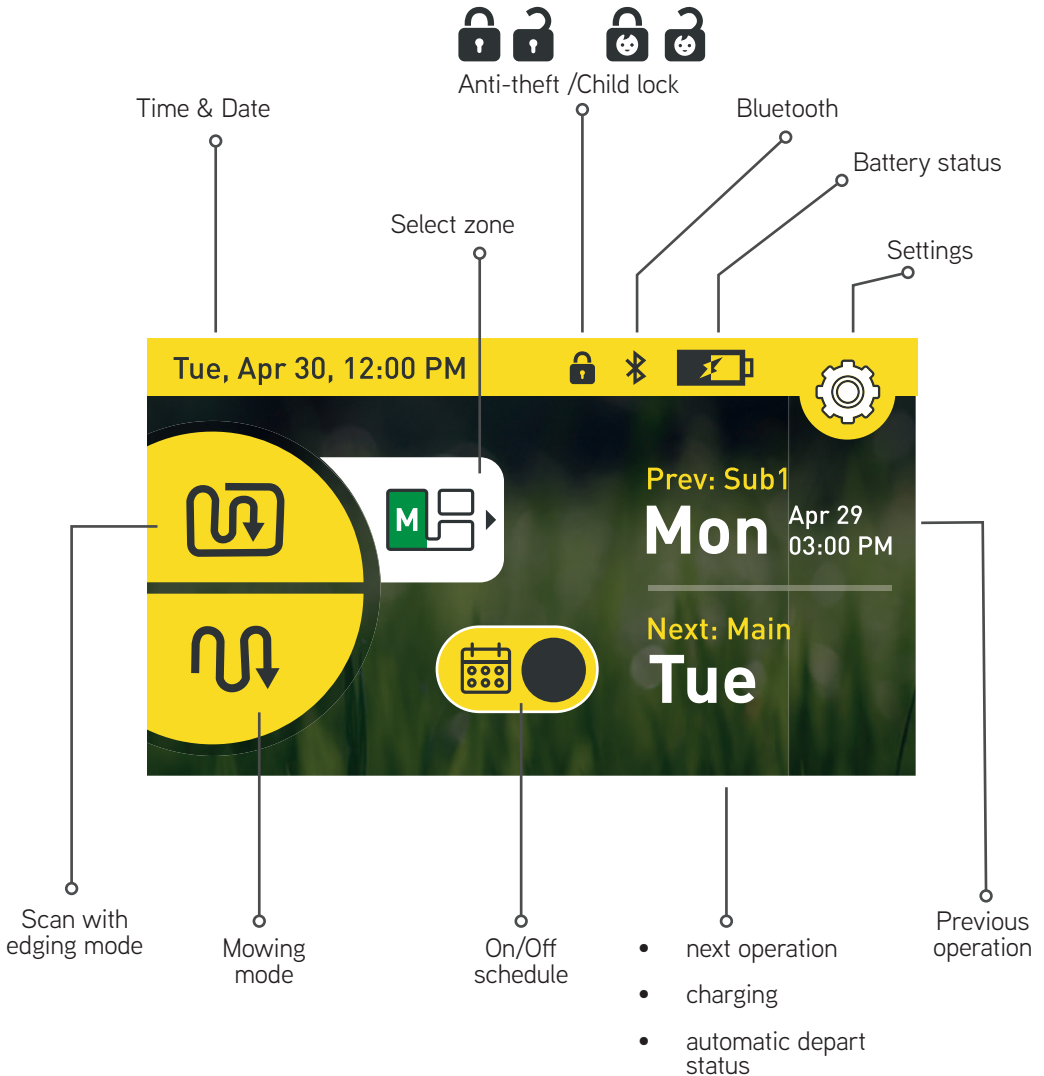

LCD display

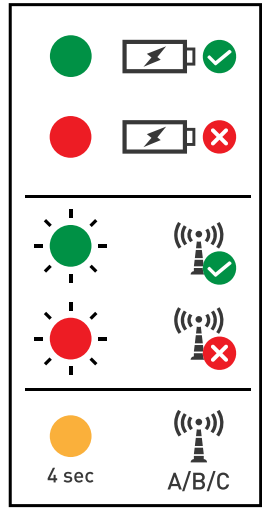
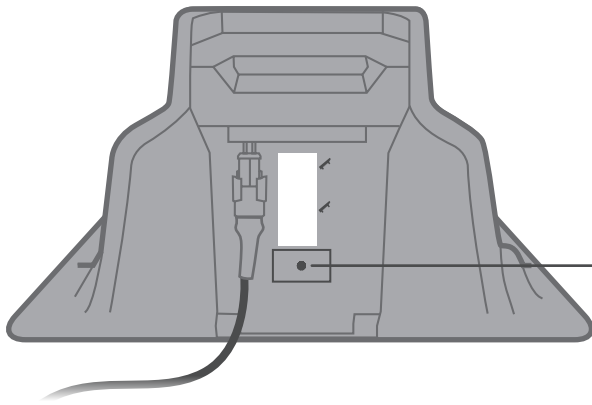

Base Station LED indication



LED indication

Indication	Meaning
 Steady green	Perimeter wire signal is OK; the mower is inside the base
 Blinking green	Perimeter wire signal is OK; the mower is outside the base
 Steady red	No charging
 Blinking red	Poor perimeter wire connection or the wire is too long
 Orange	Type signal has changed A/B/C

2 Menu structure



Mower Options

Configure user preferences

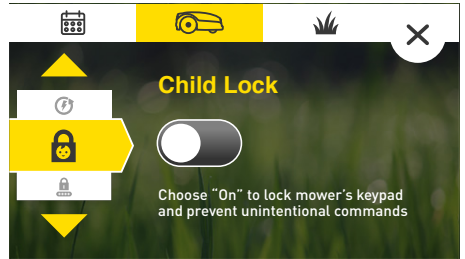

Child Lock

Lock the keypad to prevent accidental operation



Anti - Theft

PIN Code protection and alarm
in case of theft



Time and Date

Set date & time



Format

Select Time format (24/12)



Language

Change mower's
menu language



Sound
Turn Sound on/off



A/B/C

Signal Type
Change it to avoid interference with other robotic mowers around



Lawn Options

For a full description of all menu items, please refer to our online Help Center. additional to the tapping of the touch screen you can navigate the menus by using the navigation keypads arrows and make a selection by pressing the green Go button.



Islands

Turn On/Off



Size

Set your lawn size



Add Sub-zone

Add additional Sub-zone to the schedule plan



Near Wire Follow

Prevents wheel tracks along the same path by driving along the perimeter wire with a dynamic offset (not centred On wire)



Separated Zone

Allows you to operate the mower in your Separated Zone



Edge

Enable or disable edge mowing on automatic operations



Intensive Mowing

The mower will work in Intensive mode for 7 days

3 Automatic operation

Learn how to configure automatic operation and manually bypass/override it when needed

- The Zone Size setting is used by the mower to automatically determine the required mowing time for your lawn, and to recommend a weekly schedule for best results.
- This schedule includes the available working days, as well as the recommended working window available for each day.

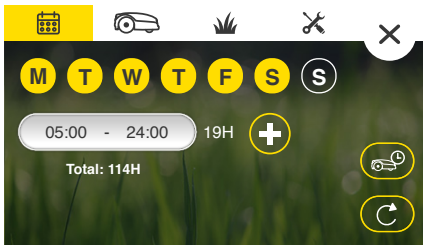

- You can modify the working days and the working window according to your needs.

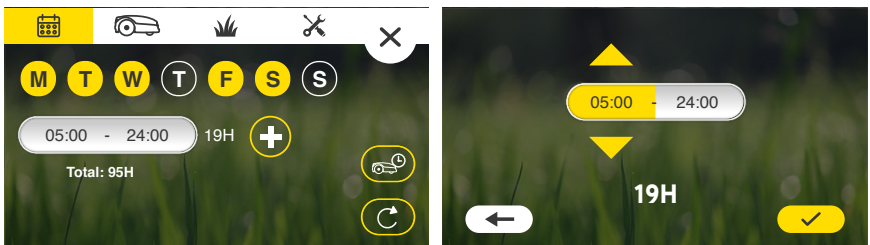

- You can split the daily working window into two separate windows if you'd like the mower to stay off the lawn for a time in between.

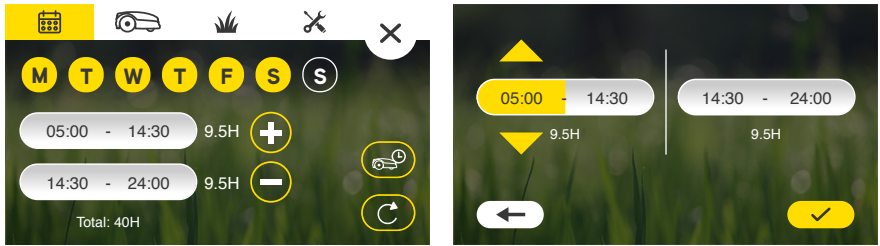

- It's important to not overly limit your mower's working time. Keeping the schedule open will allow your mower to better adapt to changing conditions and reach the needed working hours for the week.
- The mower will alert you if the number of working days and/or size of the working window is not enough to accommodate the needed weekly mowing hours.

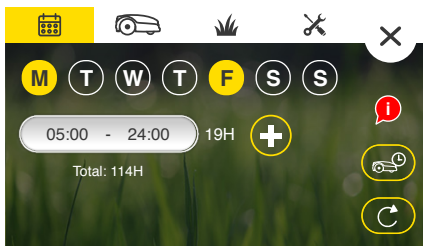

Your mower will stop mowing once it has reached the required hours for the week based on lawn size, so don't think of this schedule as necessary for preventing the mower from working too much.



TIP

Mowing Hours

- Though your Robomow determines a smart schedule based on the size you set for your lawn, you may find the need to adjust from this at times.
- The mowing time required to maintain your lawn can vary on factors such as: grass type, weather / time of year, sunlight exposure, soil drainage, fertilizing, etc... Because of this, it is recommended that you monitor the quality of your lawn and make adjustments as needed.
- Your mower allows you to adjust the automatic schedule up or down, either for all your lawn together, or differently for each sub-zone.

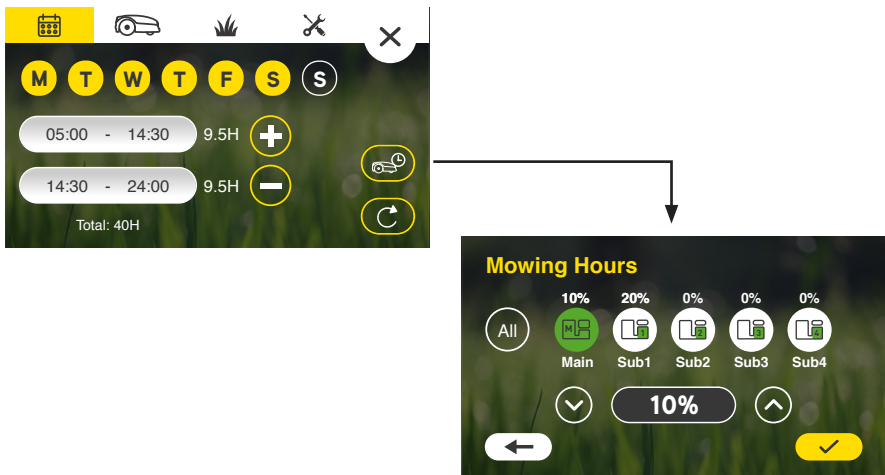

-
- Too much mowing can damage your lawn and shorten the longevity of your mower
 - Too little mowing can result in an uneven look or the inability of the mower to keep up with grass growth
-



Note:

- For best results - It is recommended to not set more than 2 days in a row without mowing.
- After the necessary mowing is completed for a given day, the mower will stay in its Base Station until the next working day.
- By default the mower will be set with intensive mode switched 'On', In this mode the mower will temporarily (for 7 days) work in the maximum capacity mowing mode. This is done to bring your lawn quickly to an even height before the mower switches into its automatic maintenance schedule.
- If at any time during the season, the mower has gotten far behind on coverage (possibly due to being switched off for an extended time, or because of a burst of very fast grass growth, etc...) you can re-enable Intensive Mowing to allow for the mower to catch back up. This will operate the mower at max. capacity for 7 days after which time it will change back to your previous schedule settings.

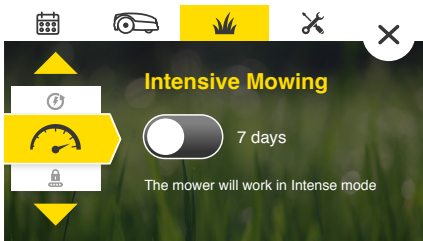

Turning automatic operation on/off

- The automatic operation comes disabled by default.
- During the one-time setup, the mower will guide you to set your lawn size and zones. When done you will be able to review the offered automatic plan, change it and enable it.
- If need you can switch off automatic departure completely by switching off the main switch on the dashboard of the mower interface.
- If you want, you can also stop automatic operation on specific zone in the lawn settings section.

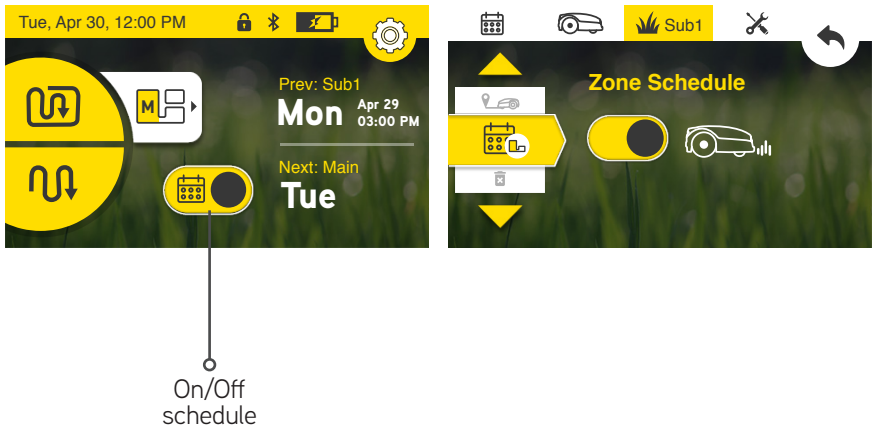

4 Manual operation

Manual Operation is used when you want to start a mowing operation, regardless of the mowing schedule.

Manual Operation with or without edging

To initiate Manual Operation:

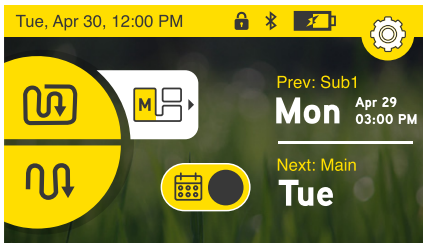

Choose between the two operation modes Edge+Mow or Mow



Select zone

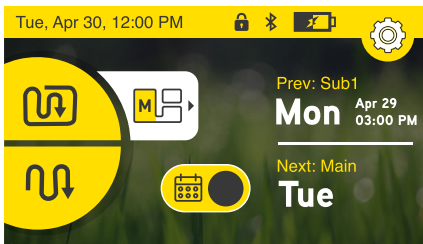

Select the zone you want the mower to mow by tapping the select zone icon.

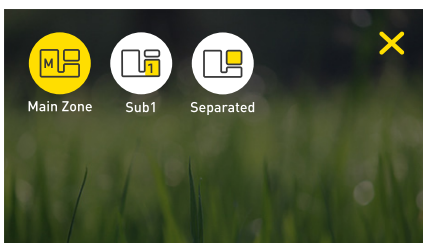

Select zone, then tap the scan mode.
Note: Edge mode is not available for Sub-zones

5 Features - how to

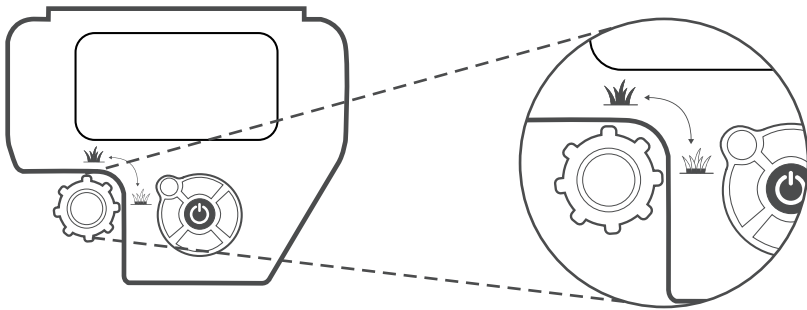

Adjusting the mowing height

- Lift the interface door at the top of the mower.
- Set the mowing height by rotating the knob left or right. The cutting height is displayed on the LCD.
- The mowing height's range is 15-100 mm (0.8-4 in)



Child Lock

This feature is turned Off by default. To turn this feature on:

Tap the settings  icon, then tap the mower  icon.

Navigate to “Child Lock” and toggle On to enable.

After a delay of 10 min without touching the screen of keypads, the mower will become locked.



To temporarily release locked keys:

Press and hold Up and Back buttons for 3 seconds.

The keys will relock after 2 min. without user intervention.

Anti-Theft / Lockout

The Anti-Theft prevents anyone from using or driving your mower unless they have a valid code to enter. By default, this feature is turned Off.

To turn it On for the first time:

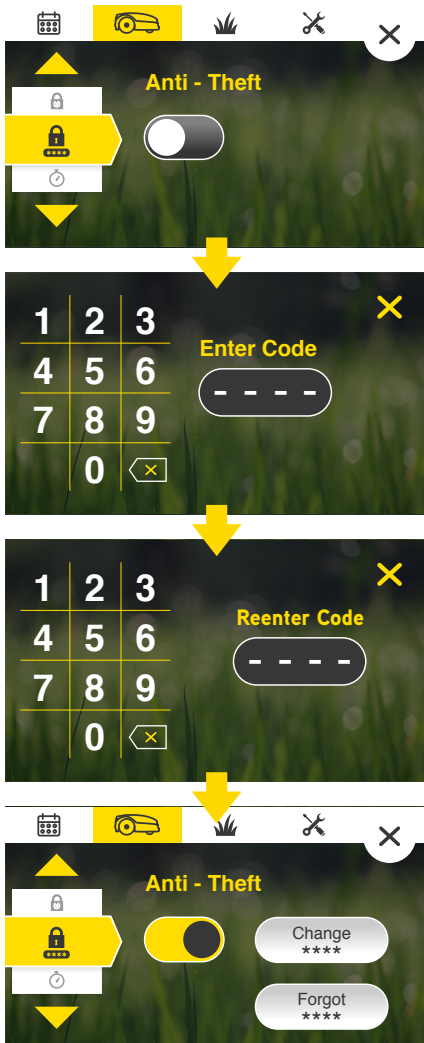

Islands

If you have big islands (like ponds or large flower beds) in this zone you can set the 'Island' switch on to help the mower find its base more efficiently.

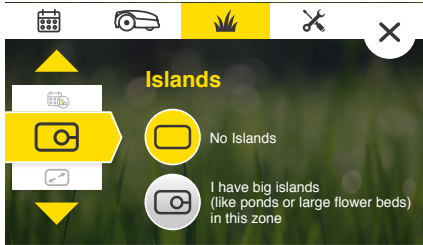

Size

This is where you set your lawn size. Lawn size is important, as it is being used by your mower to calculate the amount of mowing hours needed.



Add sub zone

You can add a new sub zone. follow the on screen instruction to set the zone size, define or let the mower measure its distance to the new zone entry, after you define the new zone you can go to it's setting and set specific settings that apply to that zone.

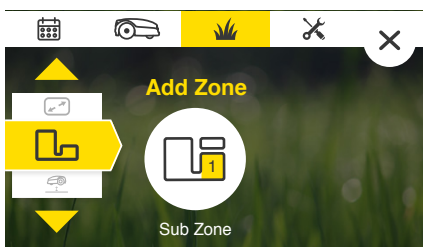

Near wire follow

Use this feature to reduce wheel tracks along the perimeter when the mower travels back home to the base station. It works by allowing the mower to travel at various distances from the wire on each trip instead of always being centered directly over the wire.

Each lawn is different, so will require some experimentation to find the optimum min. and max. values.

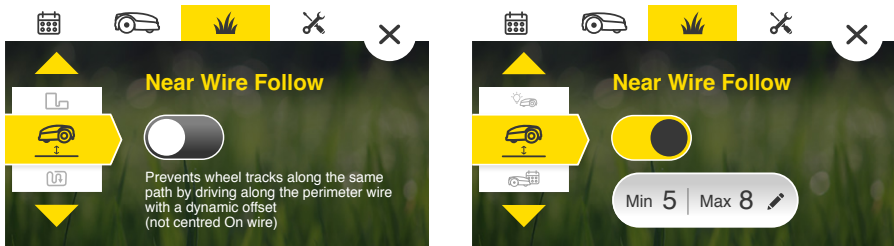

Separated Zone

If you have a separated zones in your lawn, you need to set the separated zone switch to 'ON'. this will enable you to choose a separated zone on the zone selection screen and will have the option to mow a full or half operation on this zone. remember to bring your mower to base at the end of an operation on a separated zone so it can charge and be ready to continue the automatic plan without missing an operation.

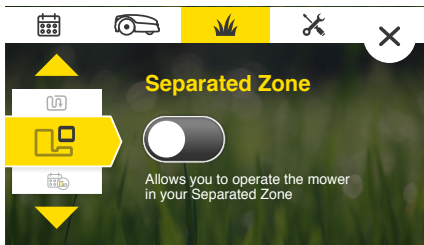

Intensive mode

If at any time during the season, the mower has gotten far behind on coverage (possibly due to being switched off for an extended time, or because of a burst of very fast grass growth, etc...) you can re-enable Intensive Mowing to allow for the mower to catch back up. This will operate the mower at max. capacity for 7 days after which time it will change back to your previous schedule settings. (automatic operation needs to be turned on for intensive mode to be activated)

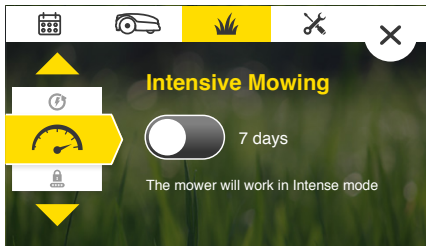

Signal type

The mower supports 3 signal types you can choose from in case you are experiencing interference with other robotic mowers in adjacent lawns. To change the signal type, put the mower in the base station and select a different signal from the one you are currently using. Allow time for the mower to sync with the base station on the new signal. You will find a BIP as soon as the signal is synced and the mower is ready.

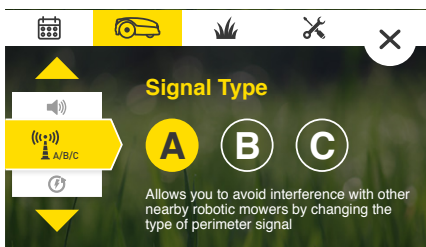

6

Periodic maintenance



WARNING

Severe injury and damage hazard!

Always remove the disabling key and switch the mower off before lifting the mower. Blades are very sharp. They can cause severe cuts or lacerations. Always wear heavy work gloves when working with or around the blades. NEVER use a damaged or broken blade.

Every couple of week

- Inspect the underside of the mower. Clean every couple of weeks if necessary. Carefully scrape the collected grass debris (using a small stick or similar object) from under the mowing deck.
- Check the Perimeter Wire and add pegs where it is loose and not tight to the ground. In case of seasonal changes in the lawn, make sure to adjust the wire accordingly.
- Inspect the Base Station, clean it from mud and debris to allow proper docking.



IMPORTANT!

NEVER use high pressure water to clean the mower. Liquids can damage components. Use only a damp or wet cloth to wipe the surface clean after scraping.

Winter storage

The mower

- Turn Schedule Off and charge the mower fully in its base for 24 hours
- Remove the disabling key and switch the mower off
- Clean the mower and store it in dry indoor conditions at ambient temperatures above 0°C.

Base Station

- No winter storage is required for the Base Station. It can be left on the lawn during the winter period.
- It is recommended to disconnect the Power Supply from the mains during the winter storage period.

Winter service

- To allow better maintenance and to keep your mower in good condition, it is recommended to bring it to a certified dealer for service prior to winter storage.
- Winter service includes operations like cleaning the mower's parts and mowing deck, checking for worn parts (such as blades, drive wheels and other moving parts) and replacing them if required, testing the mower's functions and safety components, checking the battery, and uploading the latest software version, possibly including newly added features.

7

Troubleshooting

Message Displayed	Probable Cause / Event	Corrective Action
Cross Outside	The Perimeter Wire is too close to the edge.	Move the wire towards the inner side of the lawn.
	The lawn slope near the edge is too steep and causes the mower to slip outside.	Do not include areas with very steep slopes.
	The lawn's edge is too bumpy.	Fill holes and pits along the edge until level with the ground.
Stuck In Place	The mower got stuck in place. It cannot continue driving.	Check the ground for holes or indentations. Fill it with soil. Check if the Perimeter Wire is not too close to the edge. Move the wire towards the inner side of the lawn.
	Mowing system is in overload due to very tall grass or an obstacle that is stuck or wrapped around the blades.	Turn off the mower and remove the Disabling Key and inspect the blades. Remove any foreign object or excessive clogging inside the mowing deck. Raise the mowing height.
Check Power	There is a temporary power cut.	Confirm that the Power Supply unit is plugged in to mains.
	The Power Supply unit is not plugged in properly.	Confirm the Power Supply is connected with to that extension cable, and the cable is connected to the base station.
	There is no charging source detected.	Clean the charging contacts on the Base Station and verify proper connection of the Base Station to the Power Supply unit.
No Wire Signal / Waiting for Signal	Power Supply unit is unplugged or there is a temporary power cut.	Make sure the Base Station is connected to the mains supply.
	Signal generator may need to be restarted.	Disconnect the Power Supply from the mains supply and reconnect after 10 seconds.
	The Perimeter Wire is not connected to the Base Station.	Check the connection of the Perimeter Wire to the Base Station.
	The Perimeter Wire is cut.	Check for cuts in the Perimeter Wire.

8

Frequently asked questions



Mower does not dock properly and sometimes misses Base Station's contacts

The entrance to the Base Station is not flat. Fill some ground to flatten the lawn around the Base Station to allow smooth entrance. Make sure the Perimeter Wire is straight before and after the base station.



Poor quality of mowing

The blades may be dull. Turn off the mower and, remove the Disabling Key and replace them If needed. Use heavy gloves when inspecting blades.



Patchy and uneven mowing

Make sure working window is big enough and Increase the mowing time via the Mowing hours setting to compensate for lawn's complexity or fast growing season



Mower does not depart from base for a long time

Tap the mower icon with the information bubble while the mower is in the Base Station. The non-depart reason code will be displayed. Refer to our online Help Center for a detailed description of non-depart codes.

