

DADO

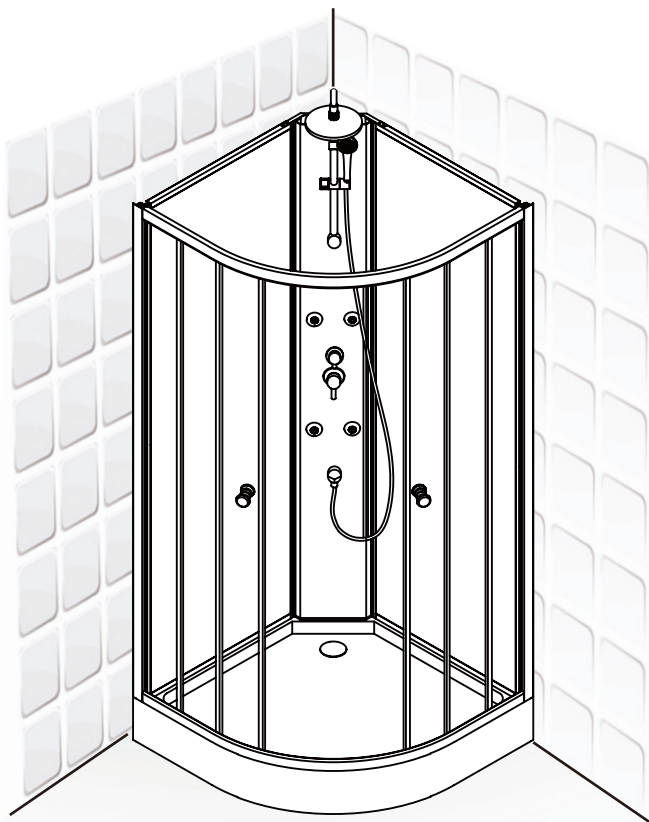

≥ 225 cm



2021/05-V02

□ DADO

85x85x225cm

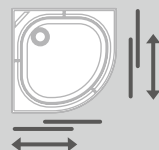

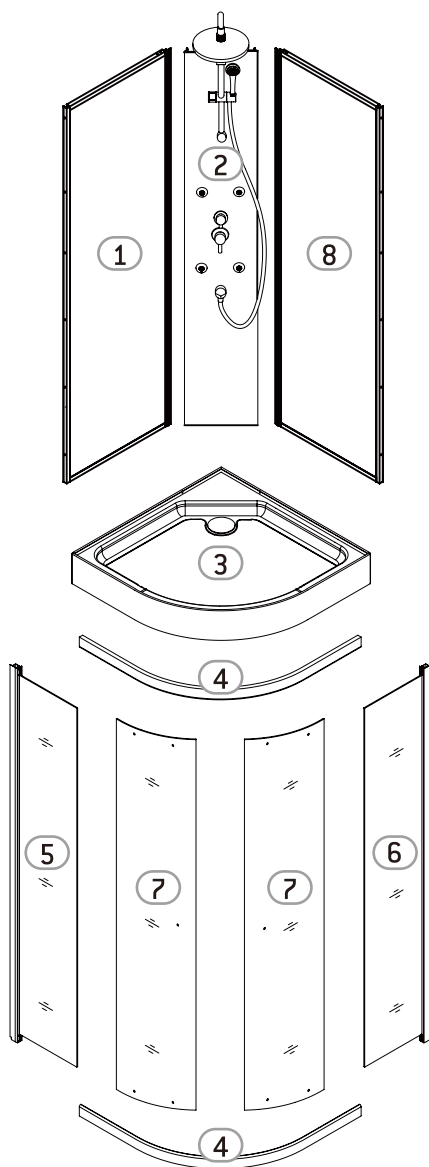

□ DADO 85x85x225cm



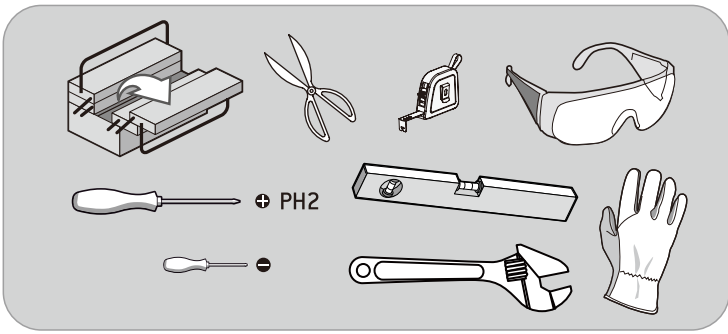
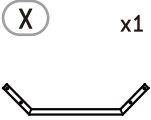
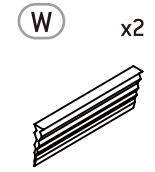
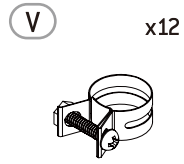
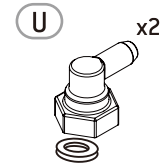
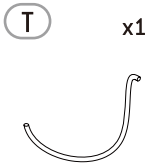
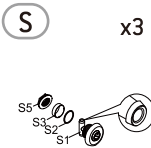
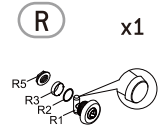
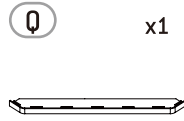
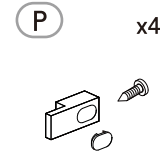
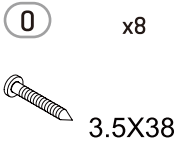
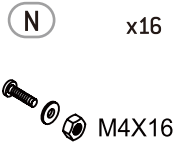
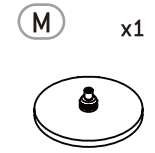
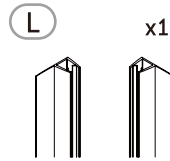
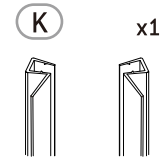
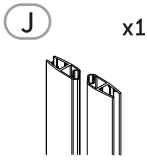
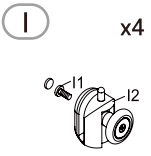
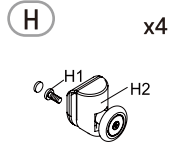
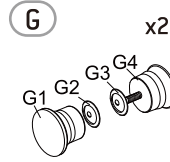
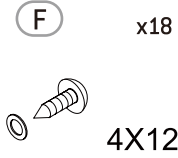
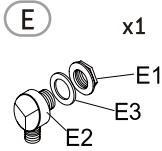
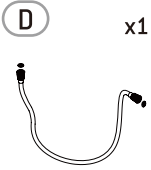
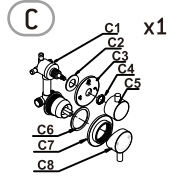
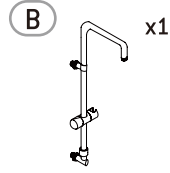
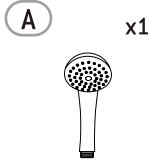
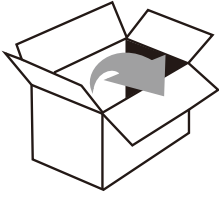

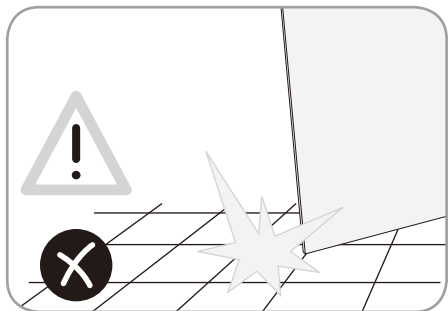
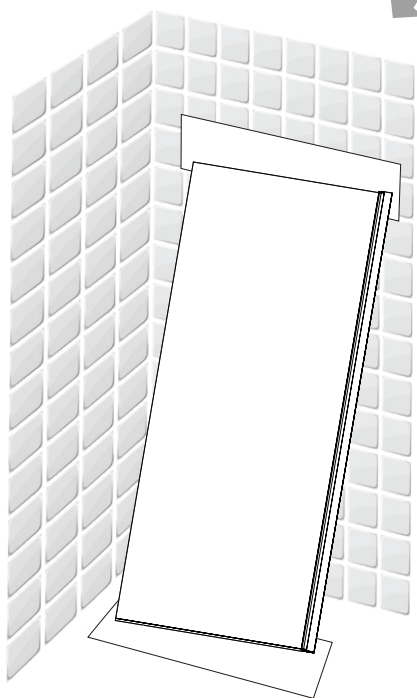
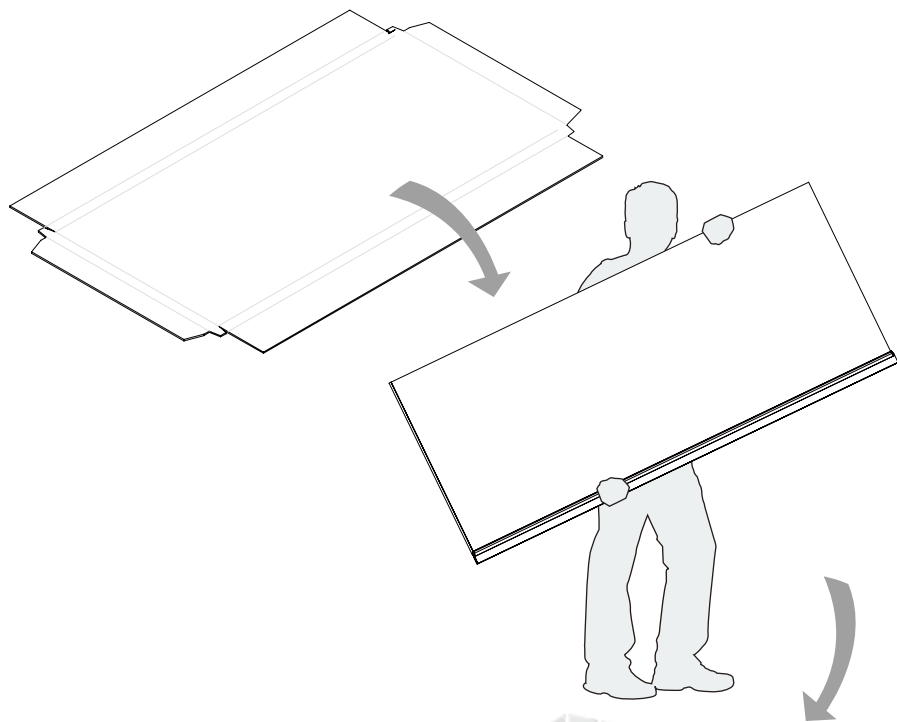

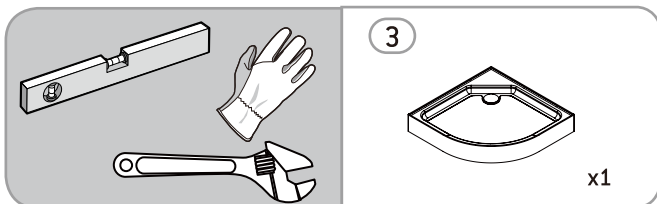
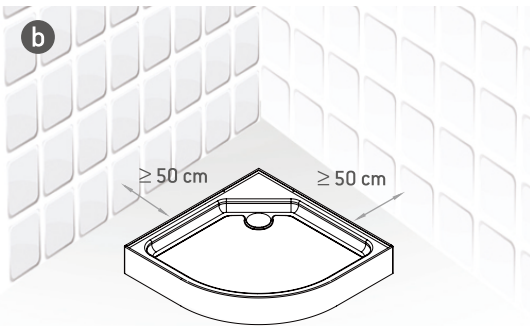
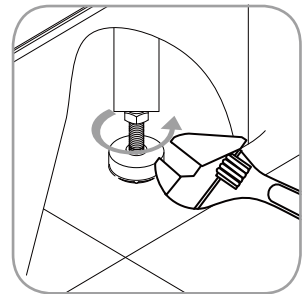
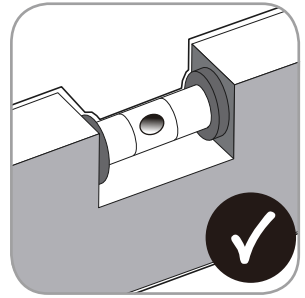
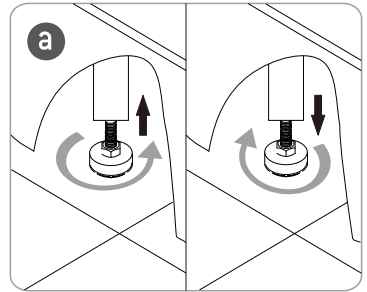
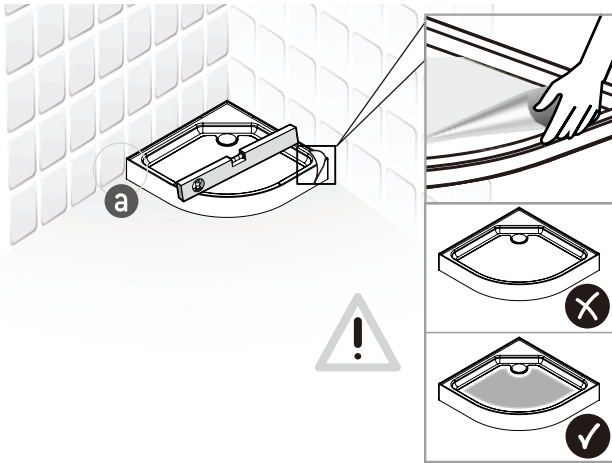

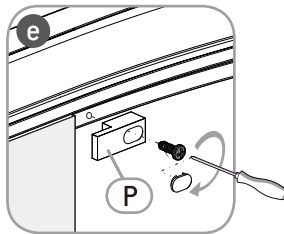
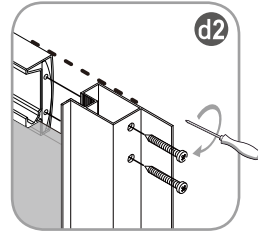
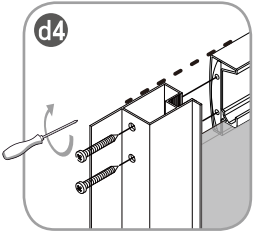
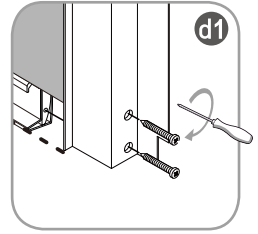
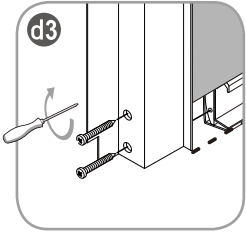
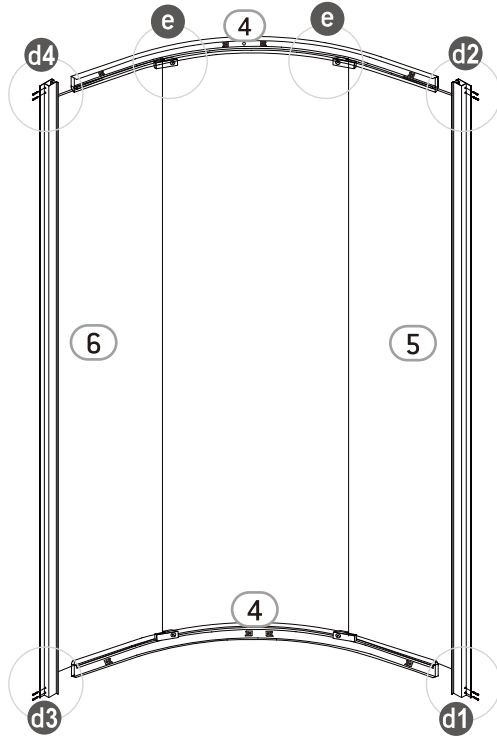







 <p>PH2</p>	<p>5</p>  <p>x1</p>	<p>6</p>  <p>x1</p>	<p>4</p>  <p>x2</p>	<p>P</p>  <p>x2</p>	<p>O</p>  <p>x8</p>
---	--	--	--	--	--

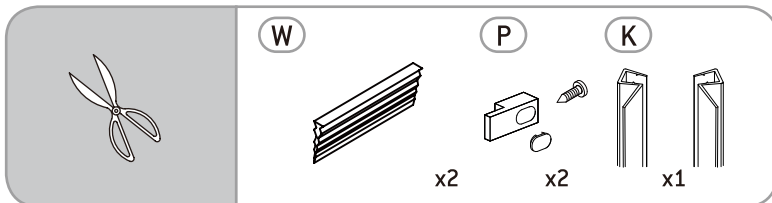
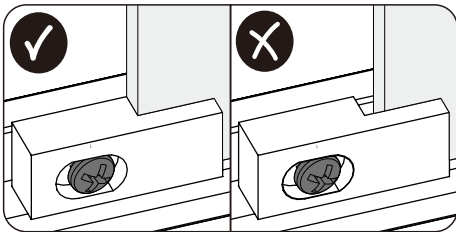
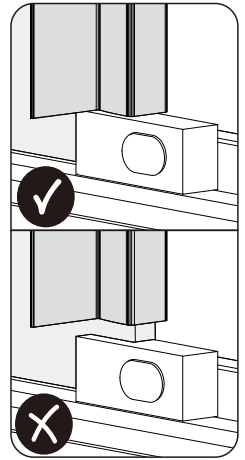
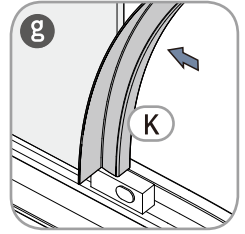
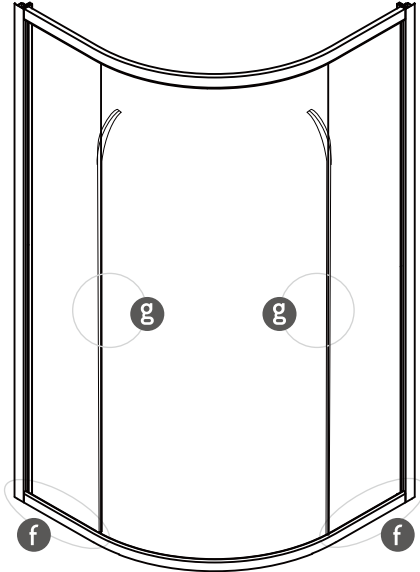
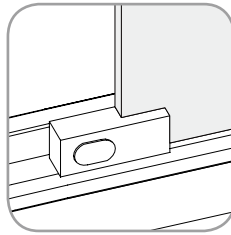
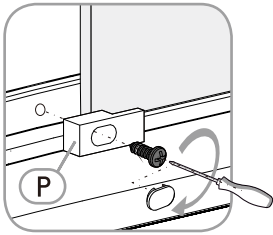
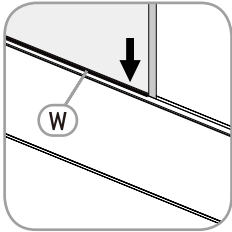
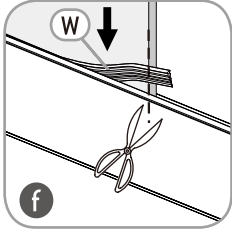

4

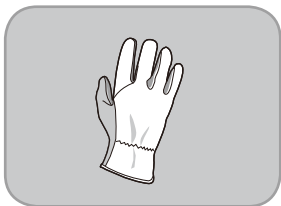
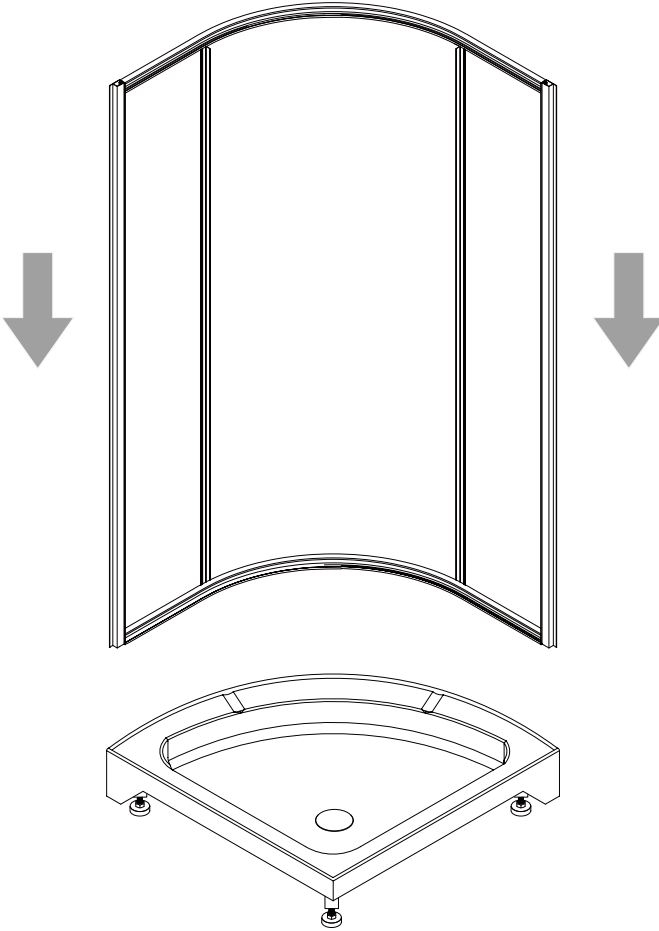

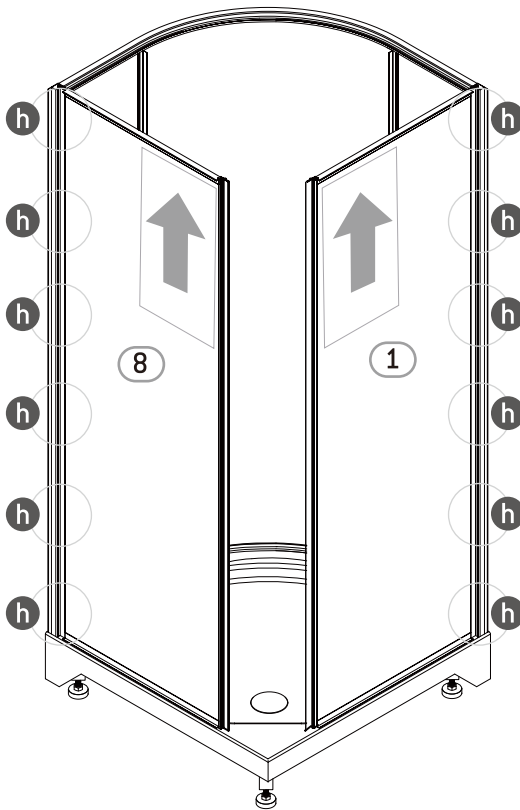
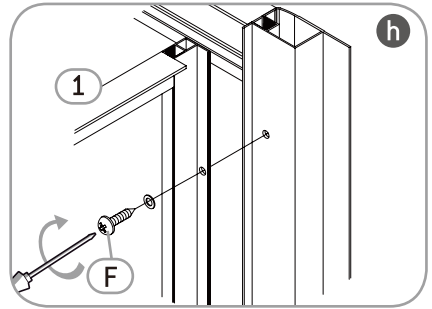
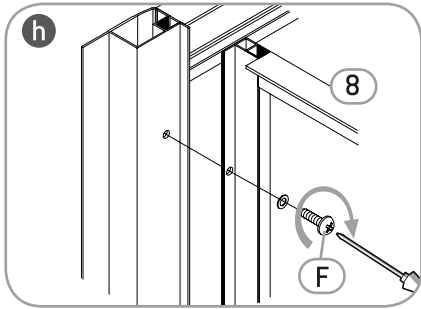

F

1

8



x12



x1



x1

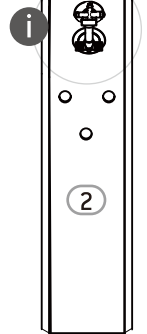
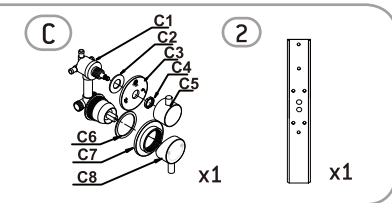
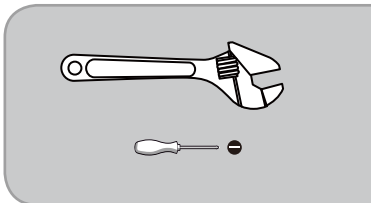
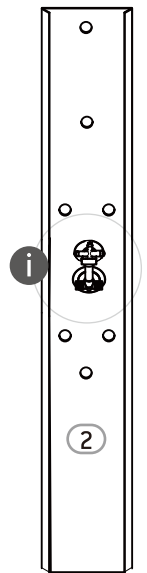
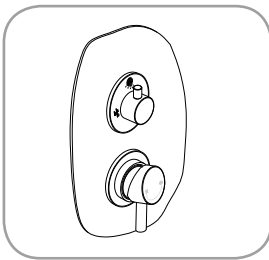
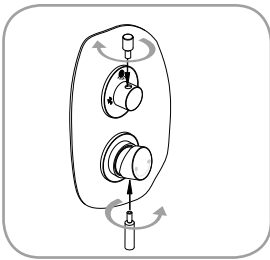
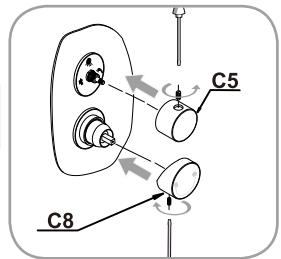
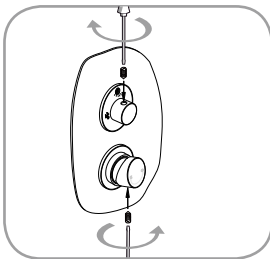
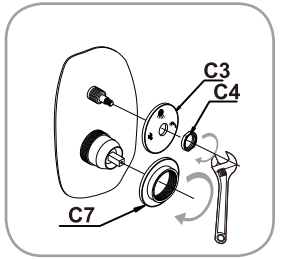
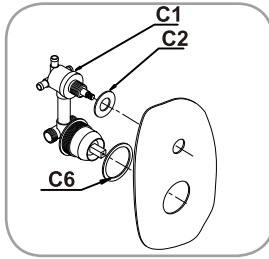
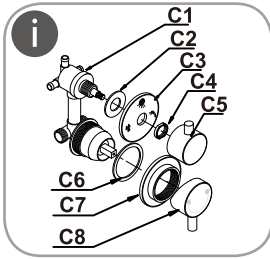
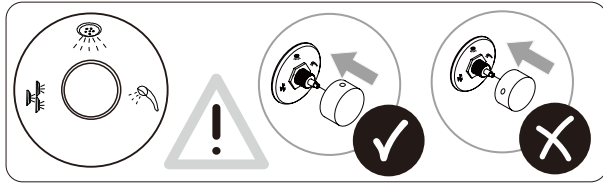

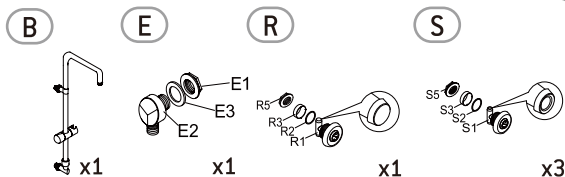
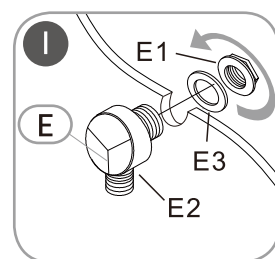
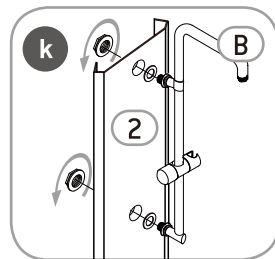
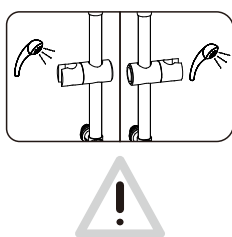
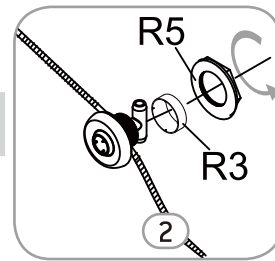
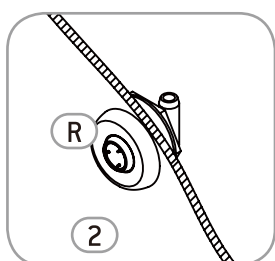
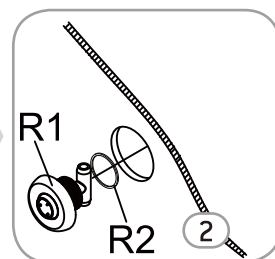
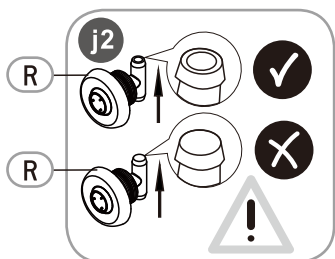
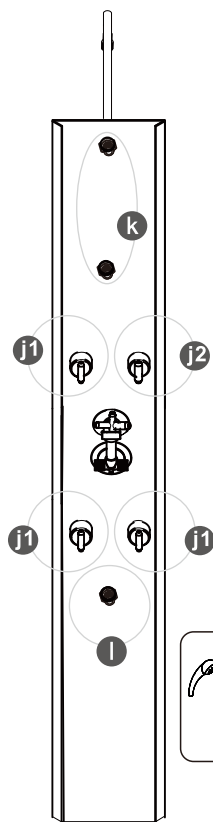
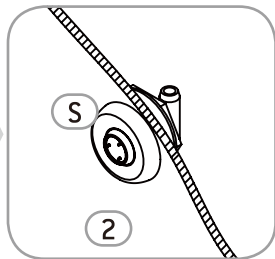
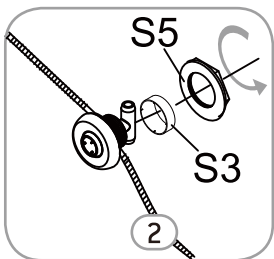
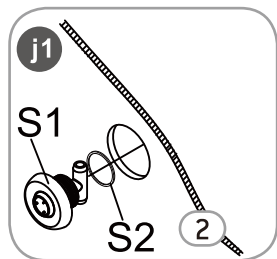

T1	28cm	x1
T2	35cm	x1
T3	39cm	x1
T4	35cm	x1
T5	29cm	x1
T6	42cm	x1

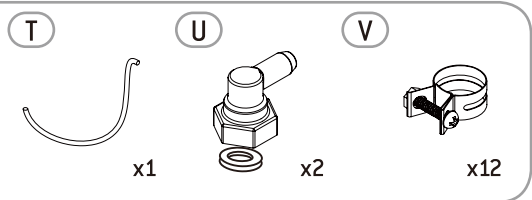
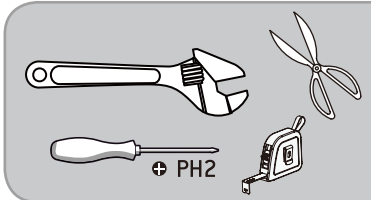
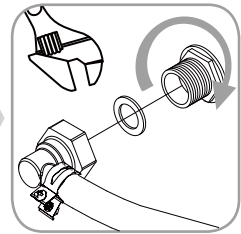
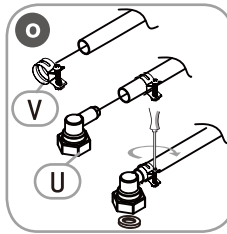
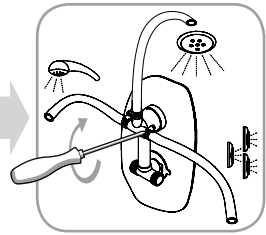
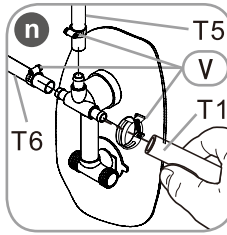
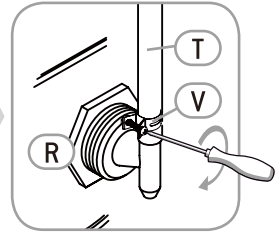
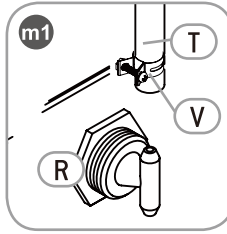
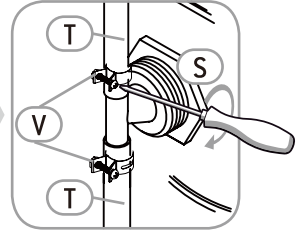
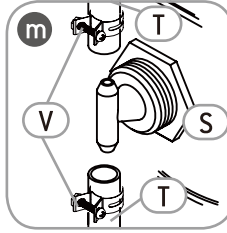
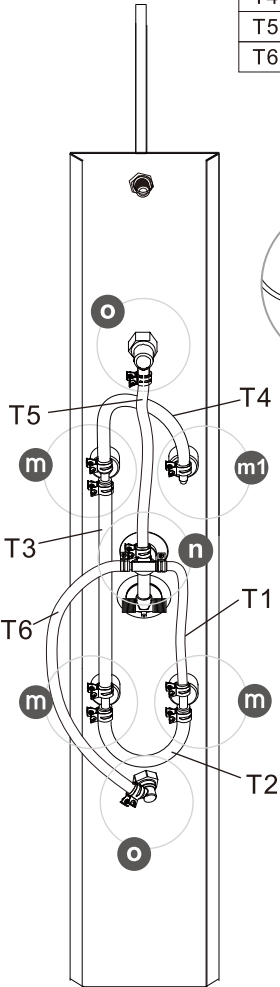

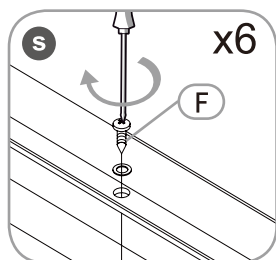
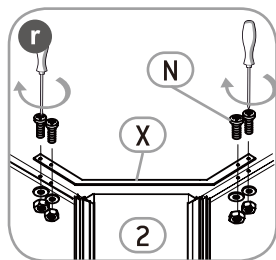
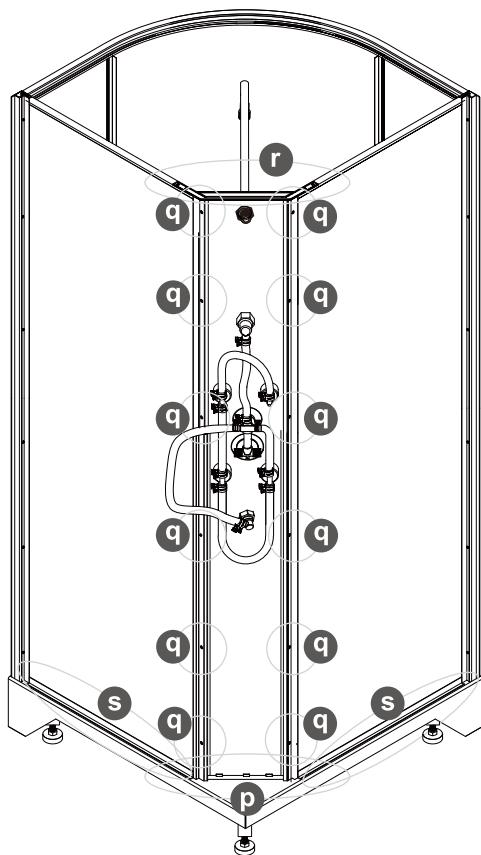
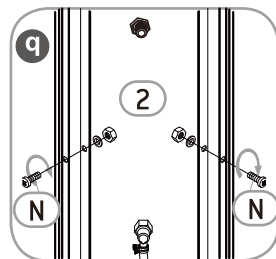
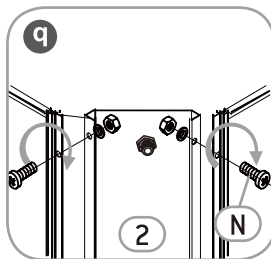
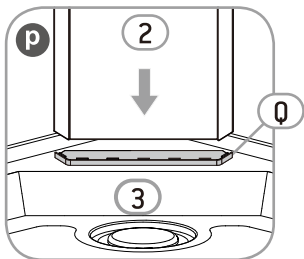

PH2



x16

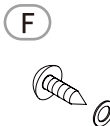

x6



x1



x1

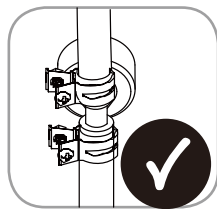
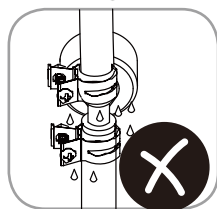
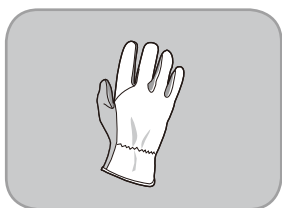
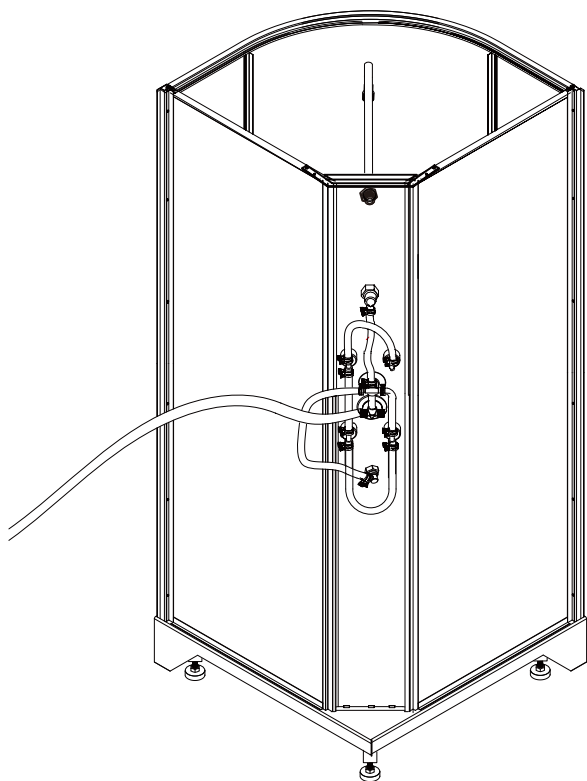

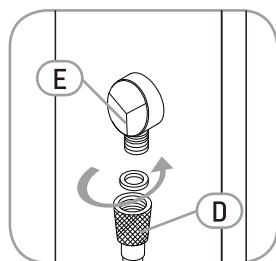
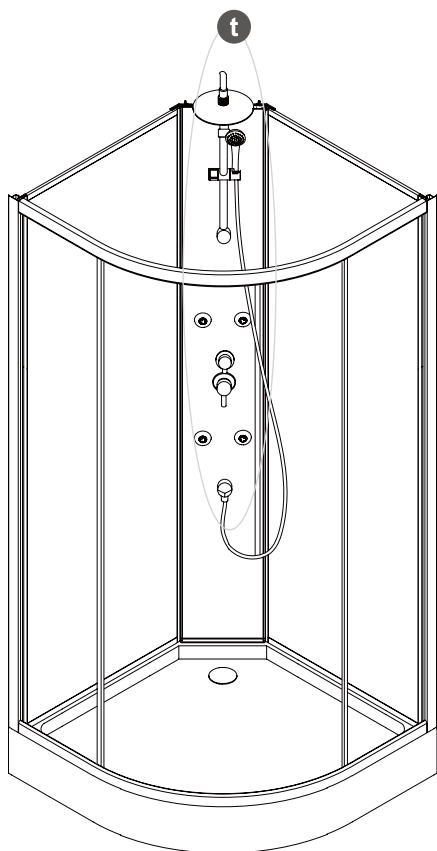
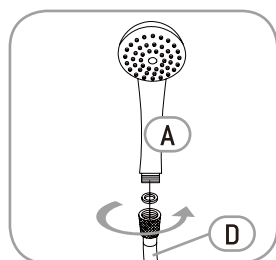
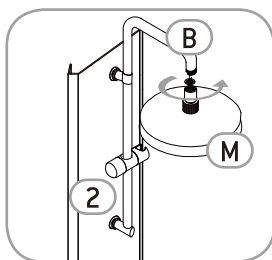
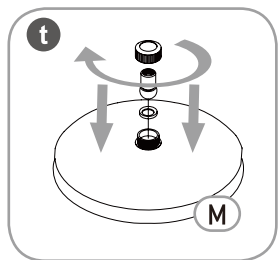

A

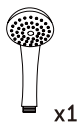

x1

D



x1

M





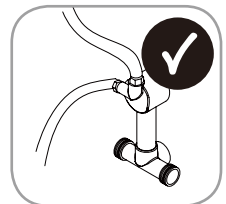
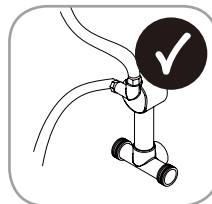
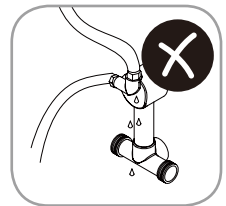
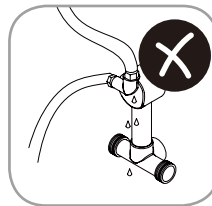
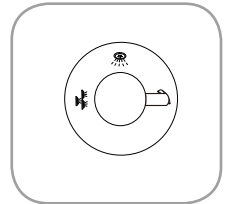
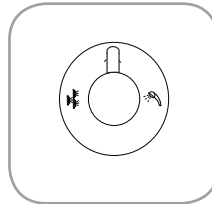
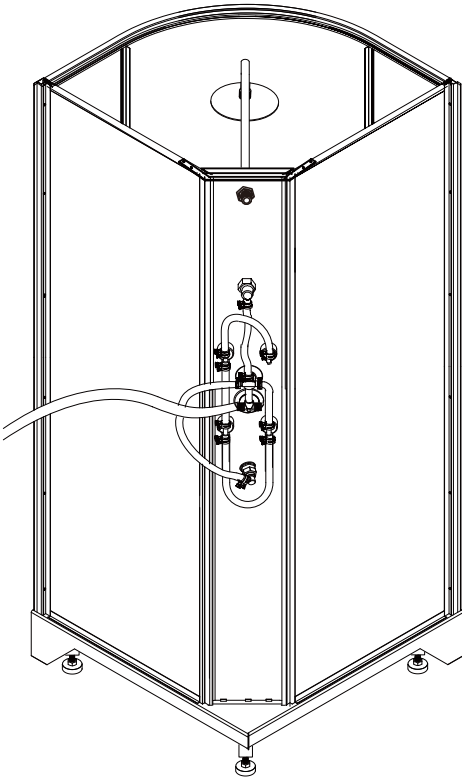
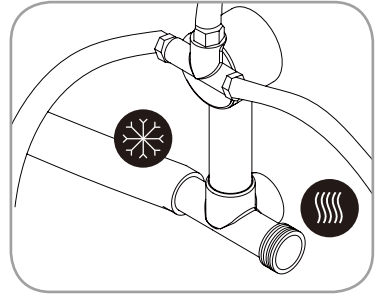

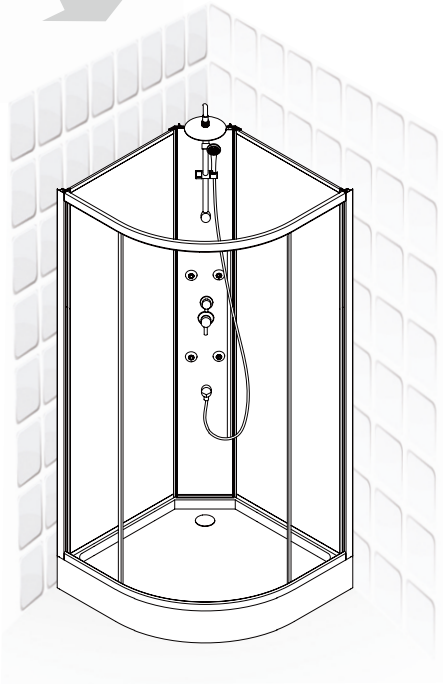
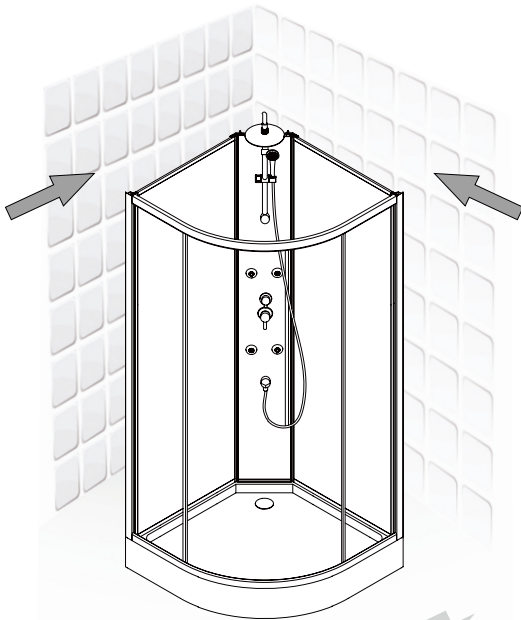
x1

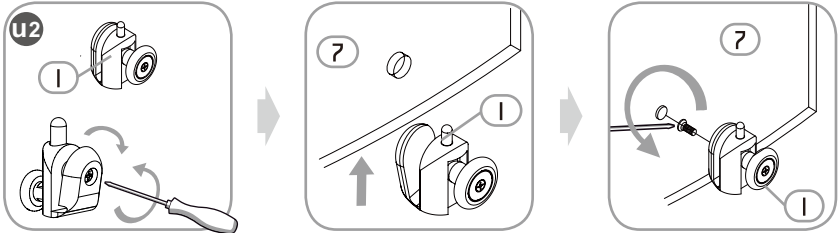
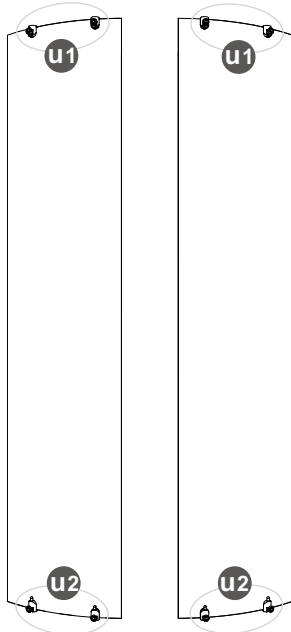
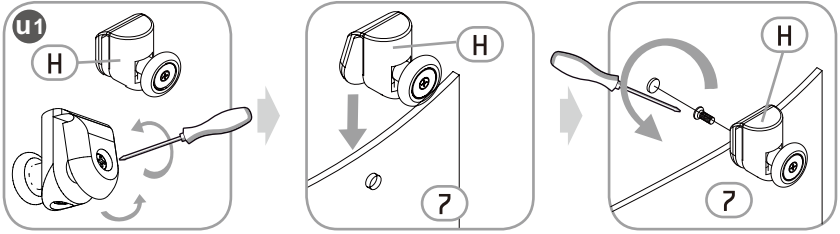

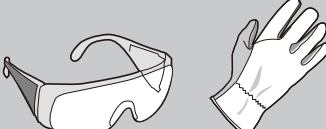



 <p>PH2</p>	<p>7</p>  <p>x2</p>	<p>H</p>  <p>x4</p>	<p>I</p>  <p>x4</p>
--	--	--	--

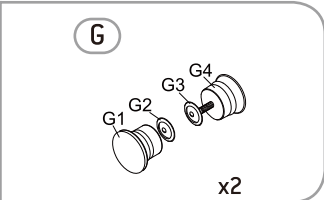
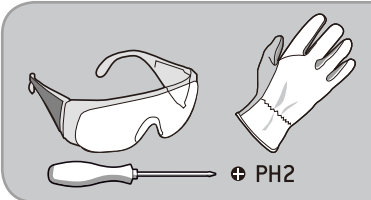
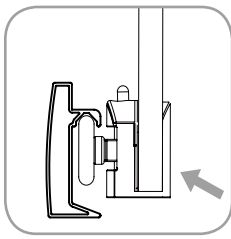
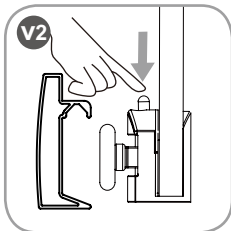
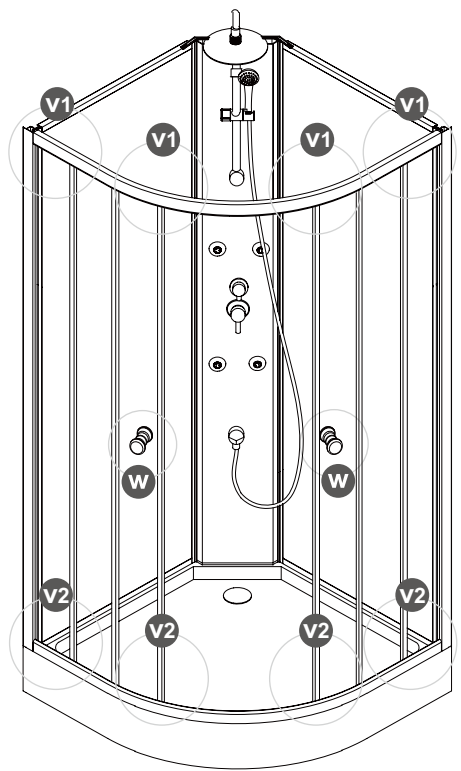
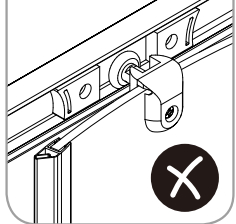
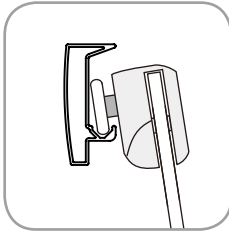
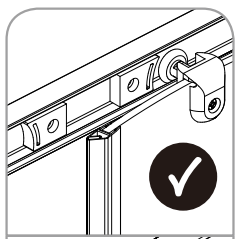
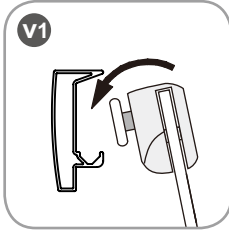
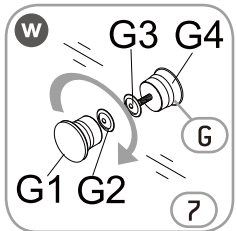

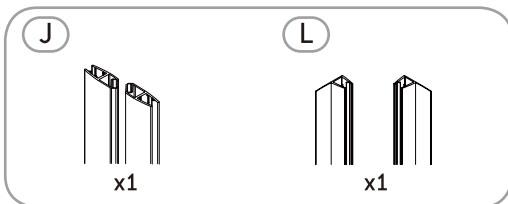
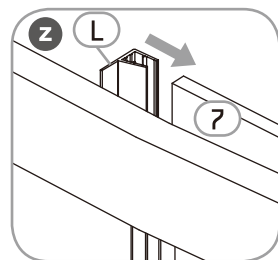
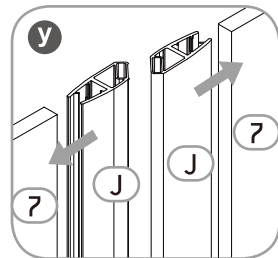
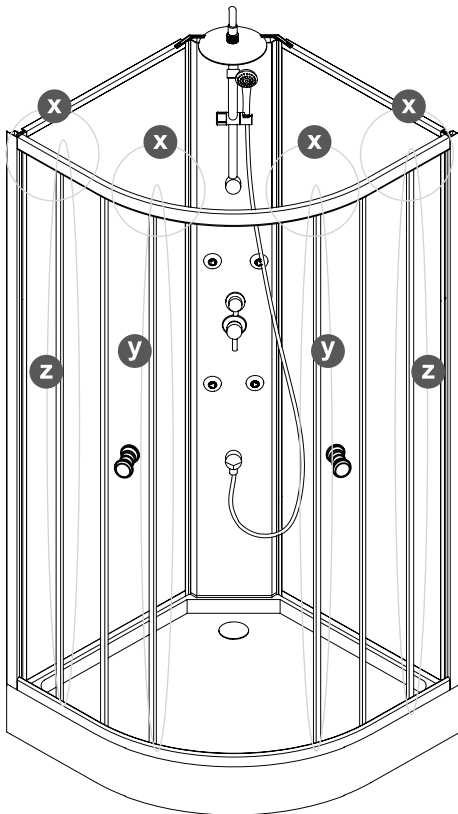
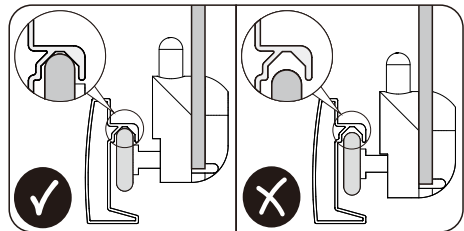
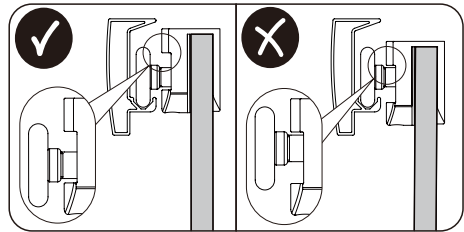
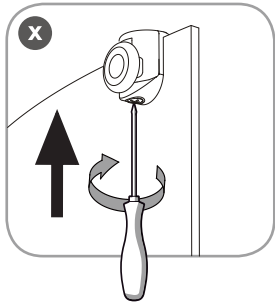

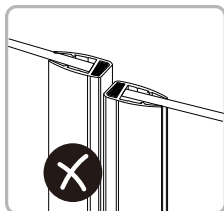
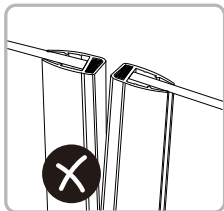
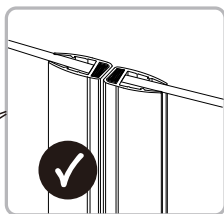
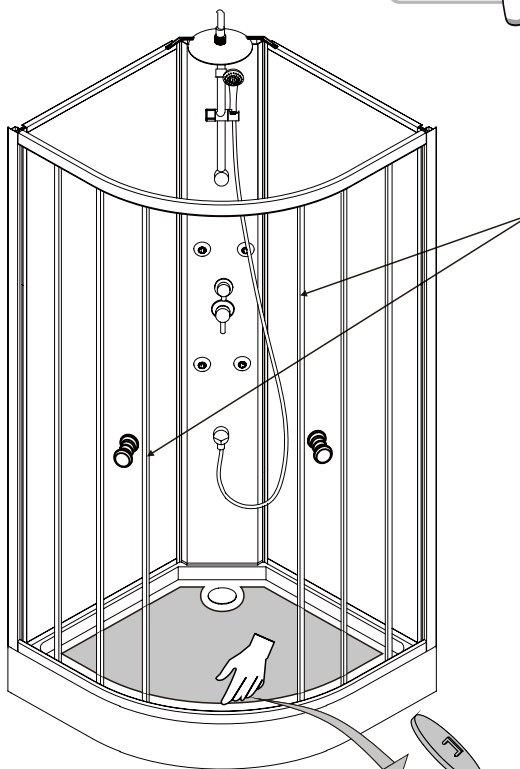
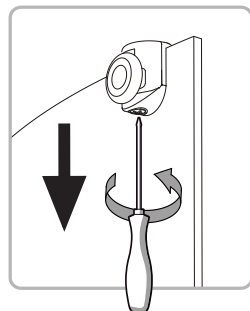
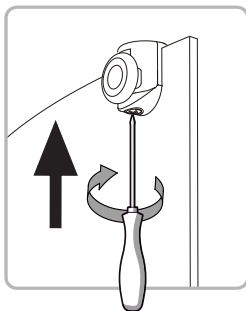



CE

ADEO Services
135 Rue Sadi Carnot-CS 00001
59790 RONCHIN-France
21
EN 14428:2004 + A1:2008

Unique identification code
of the product-type: **KS-AD-1079.V2**
Intended use: **personal hygiene**
cleanability: **pass**
Impact resistance/shatter properties: **pass**
Durability: **pass**

DOP N° 100092-2021-228694

CE

ADEO Services
135 Rue Sadi Carnot-CS 00001
59790 RONCHIN-France
21
EN 14428:2004 + A1:2008

Code d'identification unique
du produit type: **KS-AD-1079.V2**
usage prévu: **hygiène personnelle**
Nettoyable: **Conforme**
Résistance à l'impact/
Capacité de Fragmentation: **Conforme**
durabilité: **Conforme**

DOP N° 100092-2021-228694

CE

ADEO Services
135 Rue Sadi Carnot-CS 00001
59790 RONCHIN-France
21
EN 14428:2004 + A1:2008

Μοναδικός κωδικός ταυτοποίησης
του τύπου του προϊόντος: **KS-AD-1079.V2**
προβλεπόμενη χρήση: **προσωπική υγιεινή**
Δυνατότητα καθαρισμού: **Σύμφωνος με**
Αντοχή σε κραυση/
Ικανότητα κατάτμησης: **Σύμφωνος με**
Διάρκεια: **Σύμφωνος με**

DOP N° 100092-2021-228694

CE

ADEO Services
135 Rue Sadi Carnot-CS 00001
59790 RONCHIN-France
21
EN 14428:2004 + A1:2008

Código de identificação
único do produto-tipo: **KS-AD-1079.V2**
Utilização prevista: **higiene pessoal**
Limpeza: **Conforme**
Resistência ao impacto/
Capacidade de fragmentação: **Conforme**
Durabilidade: **Conforme**

DOP N° 100092-2021-228694

CE

ADEO Services
135 Rue Sadi Carnot-CS 00001
59790 RONCHIN-France
21
EN 14428:2004 + A1:2008

Code di identificazione
unico del prodotto-tipo: **KS-AD-1079.V2**
Uso previsto: **igiene personale**
Pulibile: **Conforme**
Resistenza agli urti/
Capacità di Frammentazione: **Conforme**
Durata: **Conforme**

DOP N° 100092-2021-228694

CE

ADEO Services
135 Rue Sadi Carnot-CS 00001
59790 RONCHIN-France
21
EN 14428:2004 + A1:2008

Niepowtarzalny kod
identyfikacyjny typu wyrobu: **KS-AD-1079.V2**
przeznaczenie: **higiena osobista**
Możliwość czyszczenia: **Zgodny**
Odporność na uderzenia/
Rozkruszalność: **Zgodny**
Trwałość: **Zgodny**

DOP N° 100092-2021-228694

CE

ADEO Services
135 Rue Sadi Carnot-CS 00001
59790 RONCHIN-France
21
EN 14428:2004 + A1:2008

Código de identificación
única del producto tipo: **KS-AD-1079.V2**
Uso previsto: **higiene personal**
Limpiable: **Conforme**
Resistencia al impacto/
Capacidad de fragmentación: **Conforme**
Durabilidad: **Conforme**

DOP N° 100092-2021-228694

CE

ADEO Services
135 Rue Sadi Carnot-CS 00001
59790 RONCHIN-France
21
EN 14428:2004 + A1:2008

Cod unic de identificare
a tipului de produs: **KS-AD-1079.V2**
destinație: **igienă personală**
Posibilitatea de curățare: **Conform**
Rezistență la impact/
Capacitate de fragmentare: **Conform**
Durabilitate: **Conform**

DOP N° 100092-2021-228694



CE

ADEO Services
135 Rue Sadi Carnot-CS 00001
59790 RONCHIN-France
21
EN 14527:2006 + A1:2010 CL1 + CL2

Unique identification code
of the product-type: KS-AD-1079.V2
Intended use: personal hygiene
cleanability: pass
Durability: pass

DOP N° 100092-2021-228694

CE

ADEO Services
135 Rue Sadi Carnot-CS 00001
59790 RONCHIN-France
21
EN 14527:2006 + A1:2010 CL1 + CL2

Code d'identification unique
du produit type: KS-AD-1079.V2
usage prévu: hygiène personnelle
Nettoyable: Conforme
durabilité: Conforme

DOP N° 100092-2021-228694

CE

ADEO Services
135 Rue Sadi Carnot-CS 00001
59790 RONCHIN-France
21
EN 14527:2006 + A1:2010 CL1 + CL2

Μοναδικός κωδικός ταυτοποίησης
του τύπου του προϊόντος: KS-AD-1079.V2
προβλεπόμενη χρήση: προσωπική υγιεινή
Δυνατότητα καθαρισμού: Σύμφωνα με
Διάρκεια: Σύμφωνα με

DOP N° 100092-2021-228694

CE

ADEO Services
135 Rue Sadi Carnot-CS 00001
59790 RONCHIN-France
21
EN 14527:2006 + A1:2010 CL1 + CL2

Código de identificação
único do produto-tipo: KS-AD-1079.V2
Utilização prevista: higiene pessoal
Limpeza: Conforme
Durabilidade: Conforme

DOP N° 100092-2021-228694

CE

ADEO Services
135 Rue Sadi Carnot-CS 00001
59790 RONCHIN-France
21
EN 14527:2006 + A1:2010 CL1 + CL2

Codice di identificazione
unico del prodotto-tipo: KS-AD-1079.V2
Uso previsto: igiene personale
Pulibile: Conforme
Durata: Conforme

DOP N° 100092-2021-228694

CE

ADEO Services
135 Rue Sadi Carnot-CS 00001
59790 RONCHIN-France
21
EN 14527:2006 + A1:2010 CL1 + CL2

Niepowtarzalny kod
identyfikacyjny typu wyrobu: KS-AD-1079.V2
przeznaczenie: higieny osobista
Możliwość czyszczenia: Zgodny
Trwałość: Zgodny

DOP N° 100092-2021-228694

CE

ADEO Services
135 Rue Sadi Carnot-CS 00001
59790 RONCHIN-France
21
EN 14527:2006 + A1:2010 CL1 + CL2

Código de identificación
única del producto tipo: KS-AD-1079.V2
Uso previsto: higiene personal
Limpiable: Conforme
Durabilidad: Conforme

DOP N° 100092-2021-228694

CE

ADEO Services
135 Rue Sadi Carnot-CS 00001
59790 RONCHIN-France
21
EN 14527:2006 + A1:2010 CL1 + CL2

Cod unic de identificare
a tipului de produs: KS-AD-1079.V2
destinație: igienă personală
Posibilitatea de curățare: Conform
Durabilitate: Conform

DOP N° 100092-2021-228694



Ce meuble se recycle,
s'il n'est plus utilisable
déposez-le en déchèterie.

Notice à trier.

Pour en savoir plus :
www.quefairedemesdechets.fr

- ES Si ya no puede utilizarse, este mueble se puede reciclar, depositélo en la unidad de clasificación de residuos.
- PT Este móvel é reciclável. Quando deixar de ser utilizado, deposite-o num centro de reciclagem de resíduos.
- IT Questo mobile può essere riciclato, portatelo in un'isola ecologica se inutilizzabile.

- EL Το έπιπλο αυτό είναι ανακυκλώσιμο, εάν δεν μπορεί πλέον να χρησιμοποιηθεί τοποθετήστε το σε χώρο αποβλήτων.
- PL Mebel ten poddawany jest recyklingowi, kiedy przestaje być użyteczny należy go dostarczyć do punktu zbiórki odpadów.
- RU Эта мебель может перерабатываться, если она больше не пригодна для использования, сдайте ее в утилизационный центр.
- KZ Бұл жиһаз қайт өңдеуге келеді. Ол әрі қолдануға болмайтын жағдайда, оны қайта өңдейтін орталыққа тапсыруыңызды өтінеміз.
- UA Ця меблі можуть перероблятися, якщо вони більше не є придатними для використання, здайте їх в утилізаційний центр.
- RO Acest mobilier s poate fi reciclat, dacă nu mai poate fi utilizat aruncați-l la groapă de gunoi.
- EN This piece of furniture is recyclable. If it cannot be used anymore, please take it to the waste recycling centre.



* Garantie 2 ans / 2 años de garantía / Garantia de 2 años / Garanzia 2Anni / Εγγύηση 2 ετών /
Gwarancja 2-letnia / Гарантия 2 года / Кепілдік 2 жыл / Гарантія 2 років / Garantie 2 ani /
Garantia de 2 anos / 2-year guarantee

Made in China

ADEO Services - 135 Rue Sadi Carnot - CS 00001
59790 RONCHIN - France

ТОВ «Леруа Мерлен Україна»,
вул. Полярна 17а, м. Київ 04201, Україна

РФ Импортёр/Продавец/Лицо уполномоченное
принимать претензии по качеству товара:
ООО "ЛЕРУА МЕРЛЕН ВОСТОК", 141031,
Московская область, Мытищинский район,
г. Мытищи, Осташковское шоссе, д.1, РОССИЯ

Importado e distribuido por LEROY MERLIN
CIA BRASILEIRA DE BRICOLAGEM
Rua Domingas Galletieri Blotta, 315 - Interlagos - CEP
04455-300 - São Paulo - SP - Brazil. CNPJ: 01.438.794/0001-05
CALM (Central de Atendimento Leroy Merlin) -4020.5376 (capitais)
e 0800.0205376 (demais regiões)

Импорттаушы/Сатушы/Тауардың сапасы бойынша
наразылықтарды қабылдауға өкілетті тұлға :
«Леруа Мерлен Қазақстан» ЖШС Қазақстан
Республикасы, 050000, Алматы қ., Қонаев
көшесі, 77, «ParkView» БО, 6к., 07 оф.

Imported by Adeo South Africa (PTY) LTD T/A Leroy Merlin
Leroy Merlin Greenstone Store - Corner Blackrock Street
and Stoneridge Drive, Greenstone Park Ext 2,
Edenvale, 1610 - Johannesburg, Gauteng, South Africa

