

70 GAL / 270 L

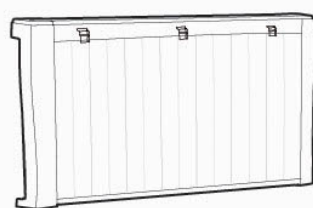

WWW.KETER.COM

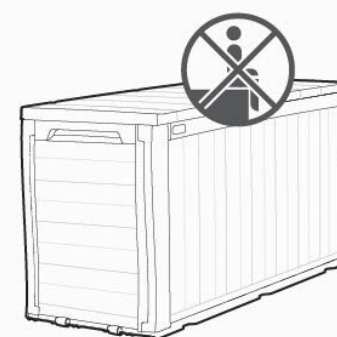
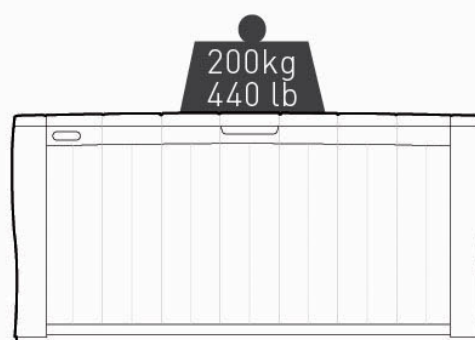
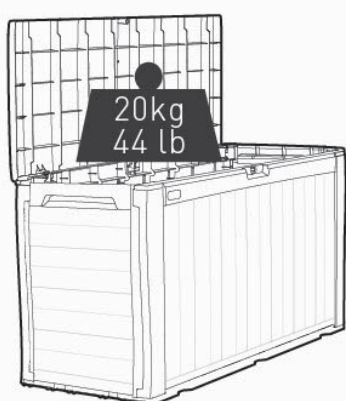
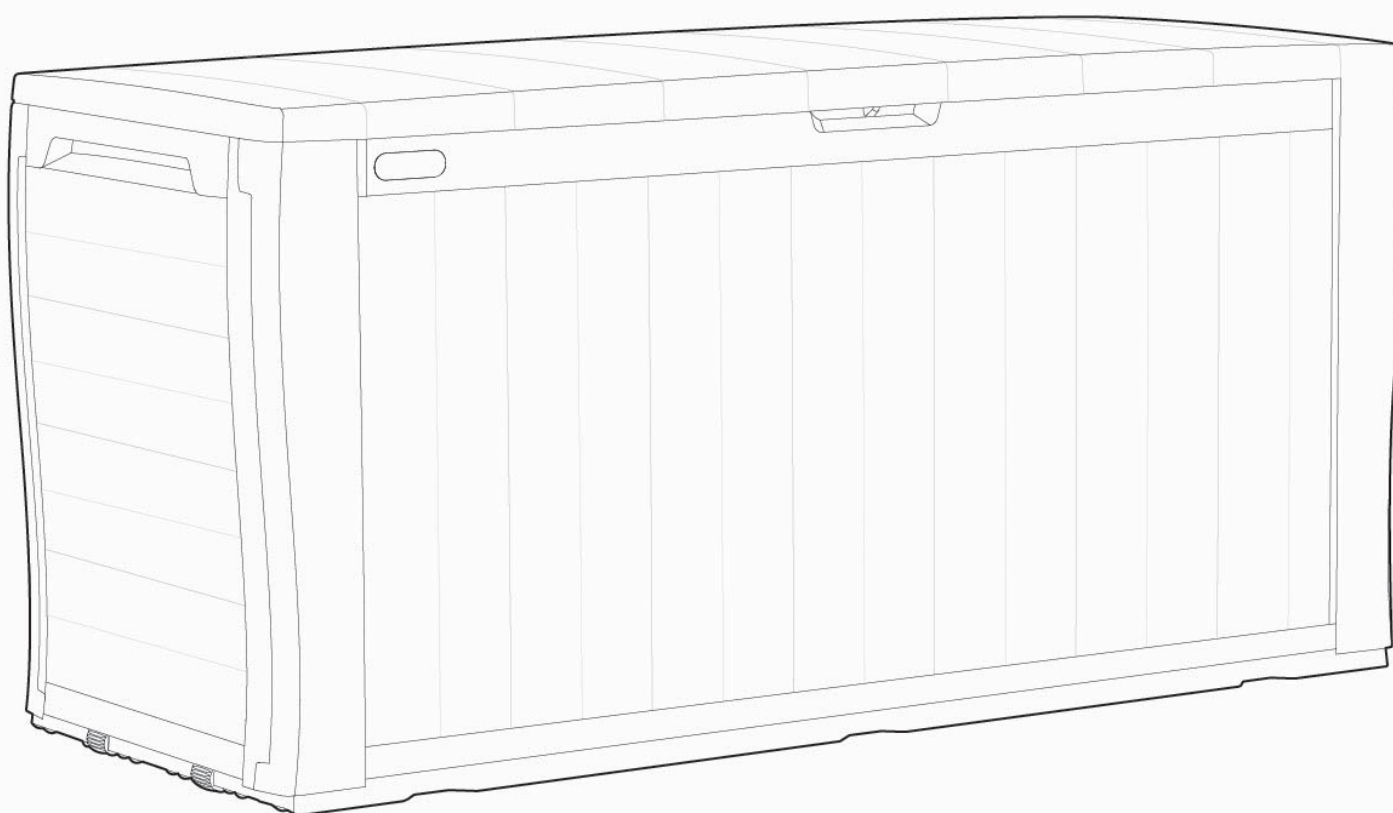

RB / SW ①

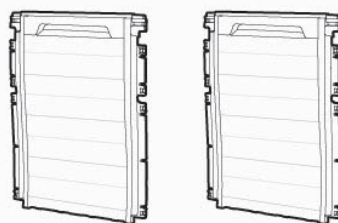

RB / SW ②

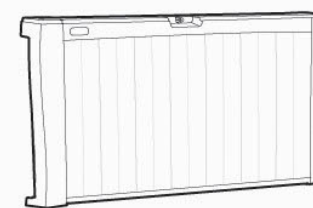

RB / SW ③

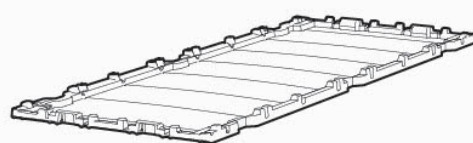

F ④

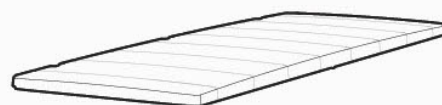

RB / SW ⑤



W ⑥

A-2174, 556249

