

**COMPACT 555**

100

01.17

# SFA



**SANICOMPACT® 555**

**FR** NOTICE D'INSTALLATION

CE

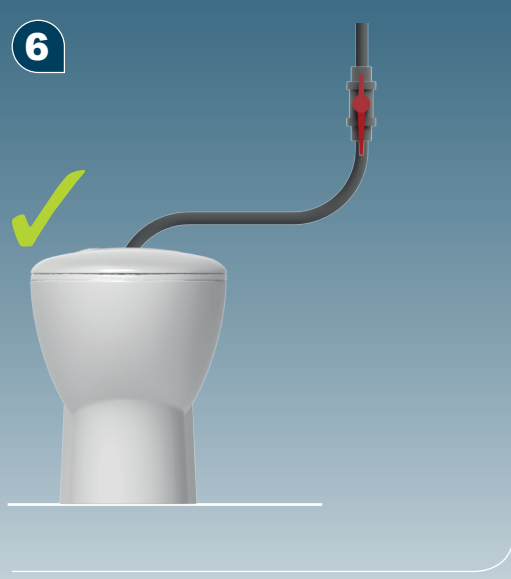
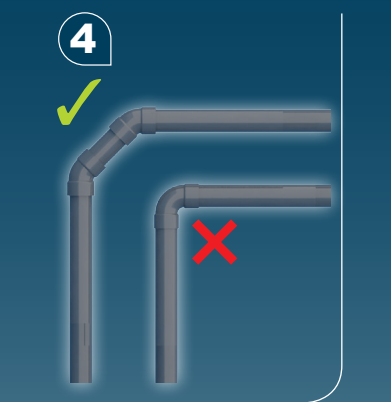
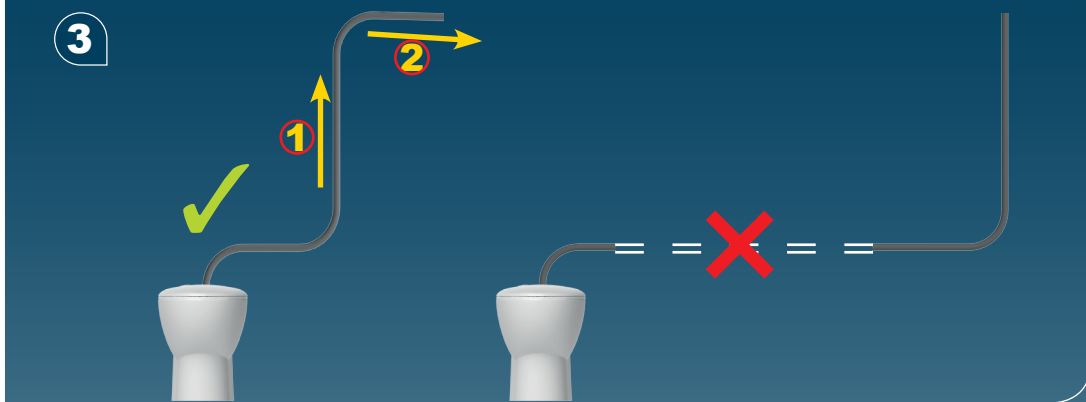
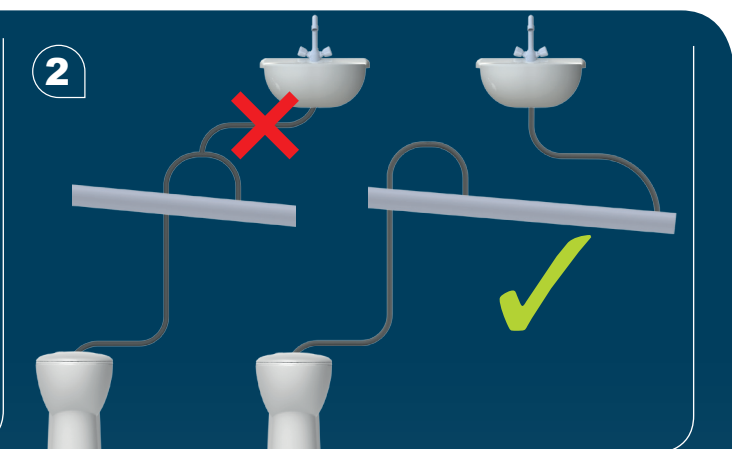
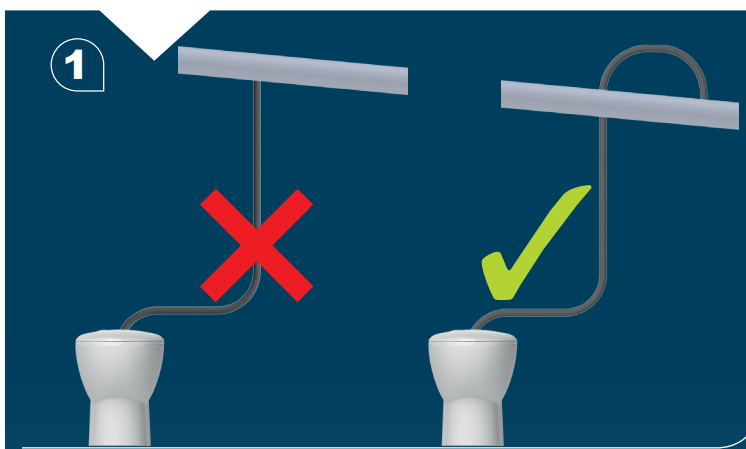
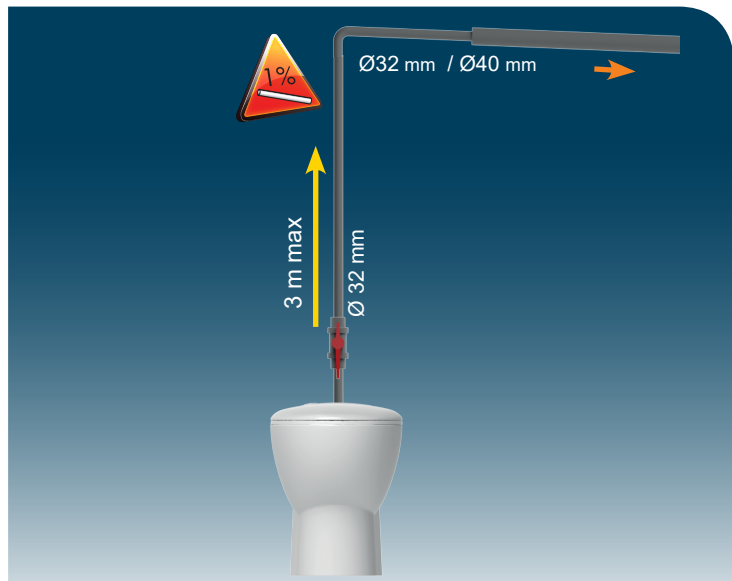

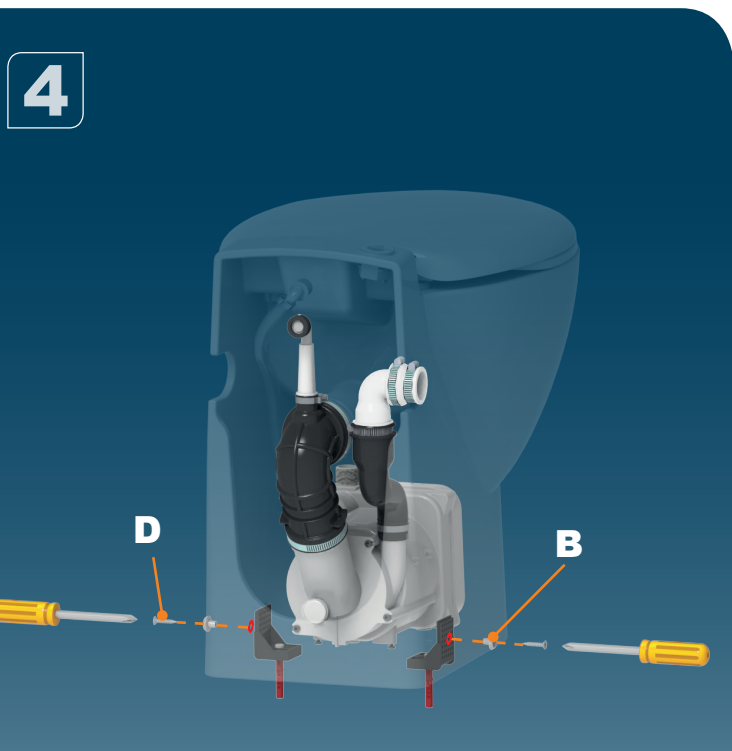
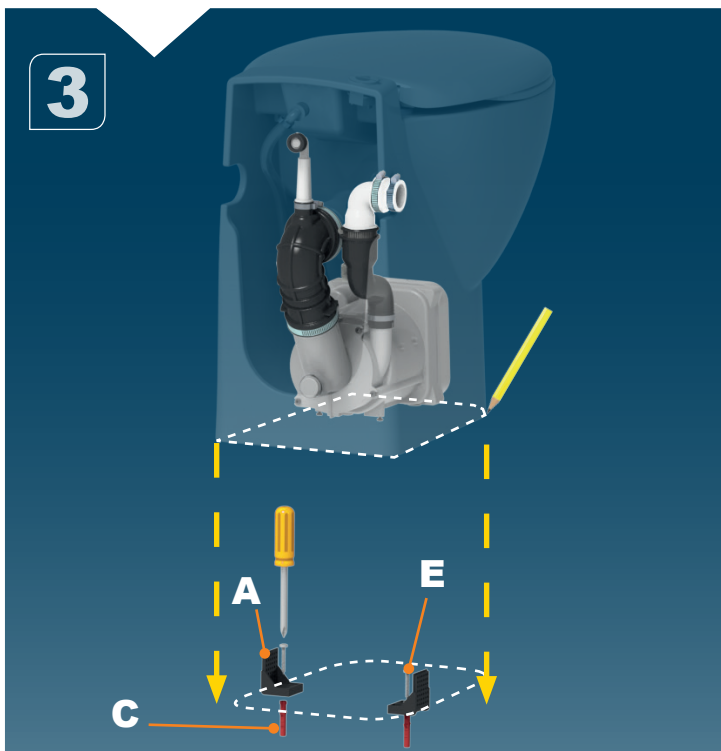
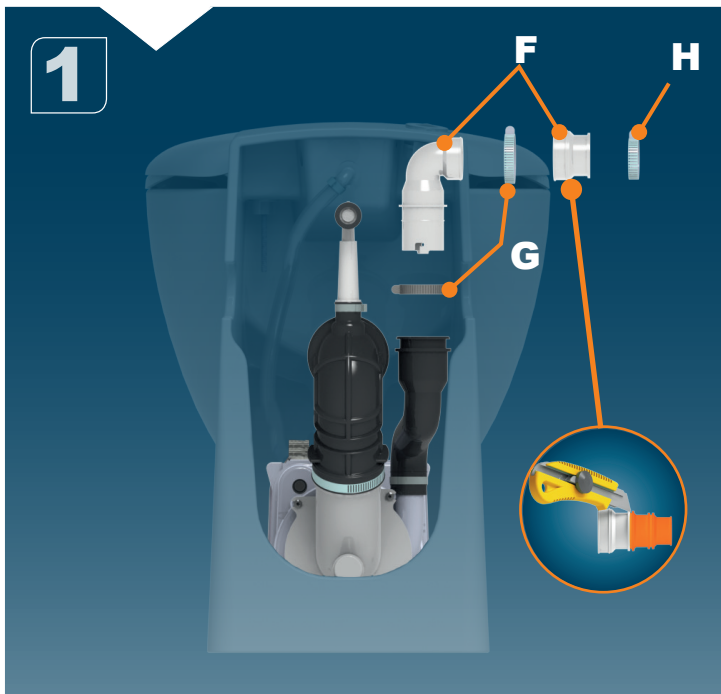
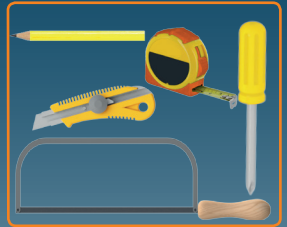
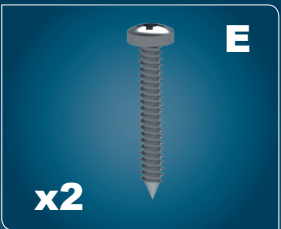
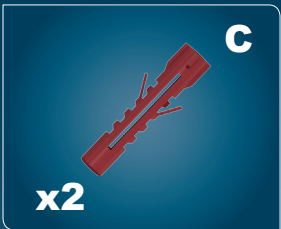
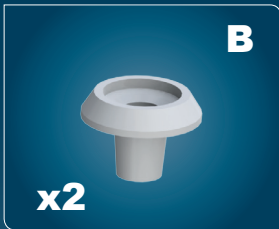
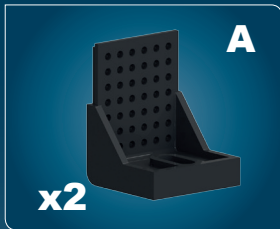

5

Avant branchement:  
faire couler l'eau  
pour évacuer les  
impuretés.

1



2



6

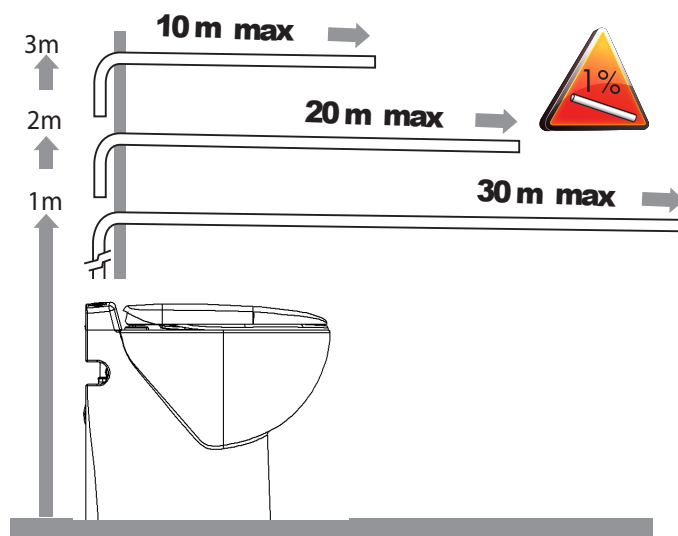
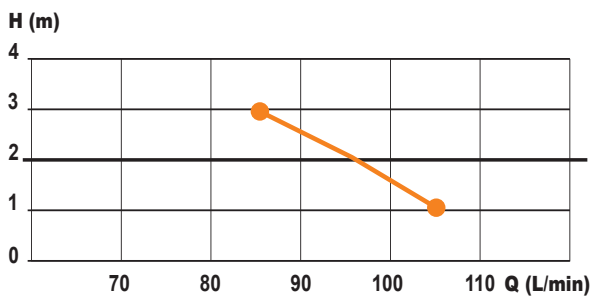
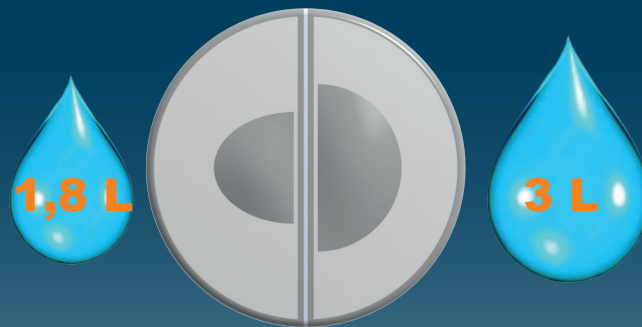
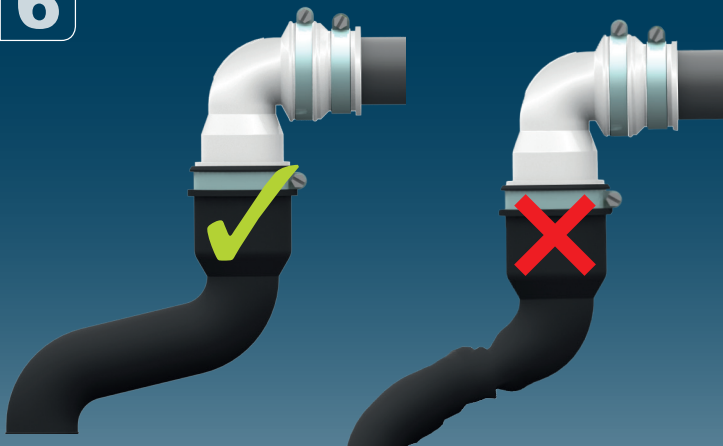

**SANICOMPACT 555  
CR15**

**220-240 V - 50-60 Hz - 2,5 A - 550 W - IP44 - ⚡**

