

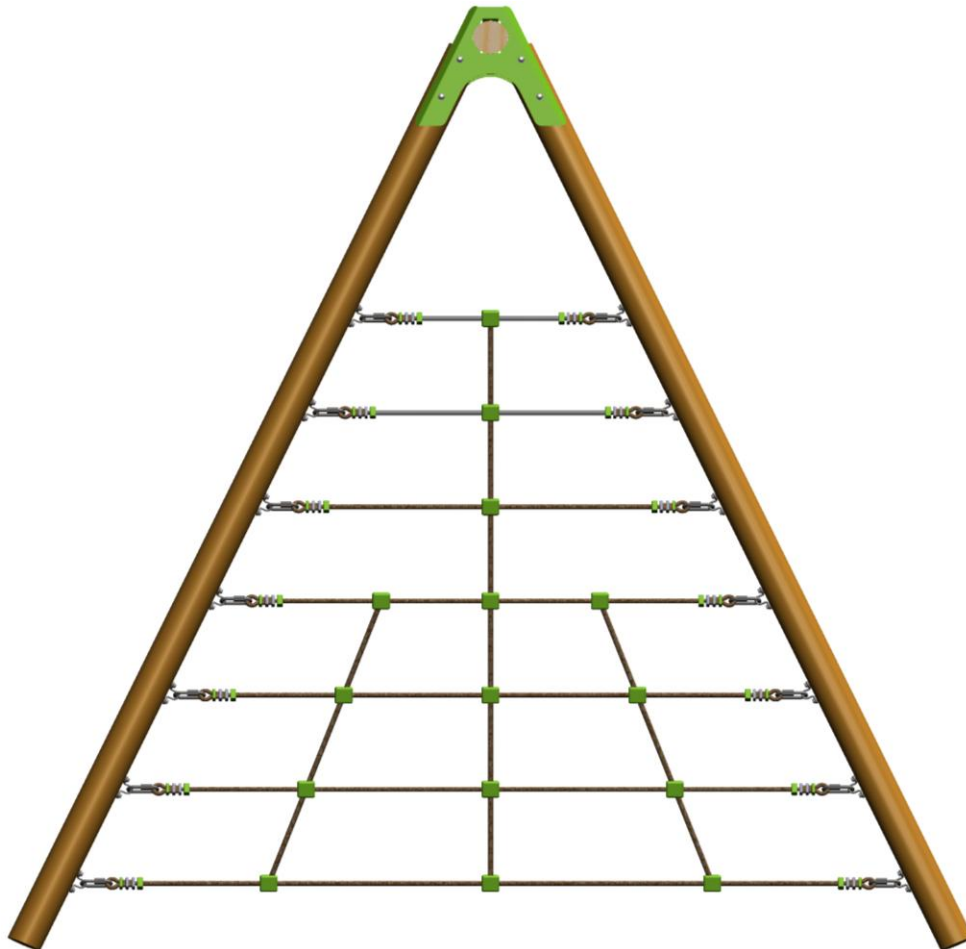

## SPIDER

Ref. J-900550

= 1H



**Notice de Montage:** lire ces instructions avant utilisation, s'y conformer et les garder comme références.

**FR** Attention ! Réservé à un usage familial en extérieur.

**Ne convient pas aux enfants de moins de 36 mois.** Age : de 3 à 12 ans.

**Instruction manual:** read these instructions before use, follow them and keep them for reference.

**EN** Warning ! Only for domestic outdoor use.

**Not suitable for children under 36 months.** Age : between 3 and 12 years old.

**Montage und Wartungs Anweisungen:** Dokument vor der Nutzung lesen und zum späteren Nachschlagen Aufbewahren.

**DE** Achtung! Nur für den Hausgebrauch im Freien.

**Nicht für Kinder unter 36 Monaten geeignet.** Alter von 3 bis 12 Jahren.

**Montaje instructie:** lees voor gebruik de gebruiksaanwijzing, volg deze op en houd deze binnen handbereik.

**NL** Waarschuwing ! Alleen privé gebruik buitenshuis.

**Niet geschikt voor kinderen jonger dan 36 maanden.** Tussen 3 en 12 jaar.

**Istruzioni per il montaggio:** leggere le istruzioni prima dell'uso, attenersi ad esse e conservarle per riferimento.

**IT** Attenzione! Riservato per uso familiare in casa.

**Non adatto a bambini di età inferiore a 36 mesi.** i 3 e i 12 anni.

**Instrucciones de instalación:** leer las instrucciones, seguirlas y conservarlas como referencia.

**ES** ¡Advertencia! Reservado para uso privado en casa.

**No conveniente para niños menores de 36 meses.** entre 3 - 12 años.

**Instruções de utilização :** ler as instruções e guardá-las como referência.

**PO** Aviso ! Apenas para uso doméstico.

**Contra-indicado para crianças com menos de 36 meses.** entre 3 e 12 anos.

# IMPORTANT

Ce cordage est destiné à être installé sur une large gamme de portiques munis de pieds en bois. Avant le montage, assurez-vous que votre portique respecte les dimensions du tableau ci-dessous. La hauteur se mesure en partant du sol jusqu'au dessus de la poutre.





Exemple : Votre portique mesure 242cm de haut. La distance mesurée au sol entre les pieds devra être entre 225cm et 265cm.

**Vous devrez mesurer ces dimensions directement sur votre portique une fois celui-ci monté et scellé. Ne pas vous référer aux dimensions fournies pas le fabricant.**

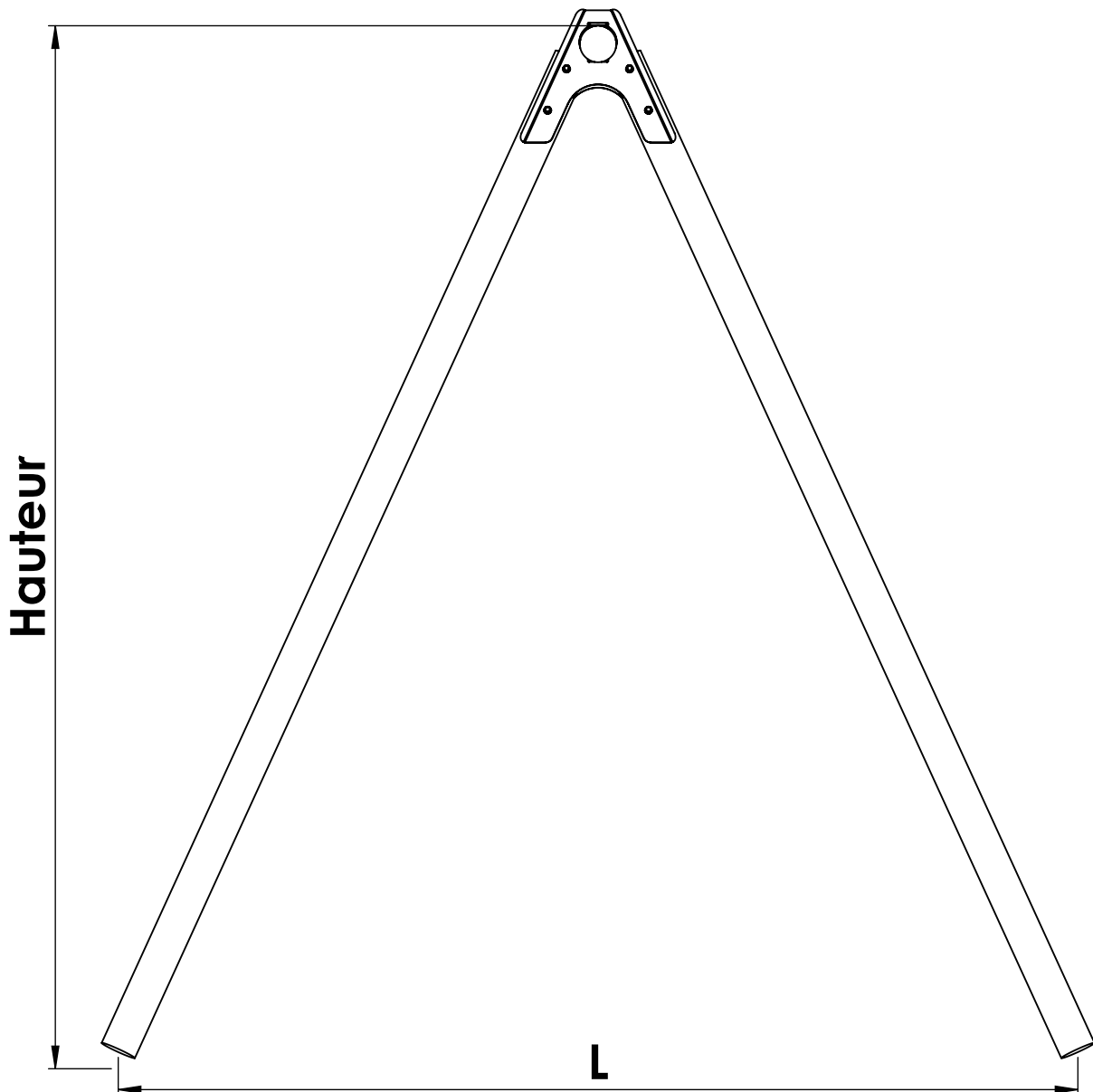
**En dehors des dimensions indiquées ci-dessous, le cordage ne devra pas être installé sur votre portique pour des raisons de sécurité.**

Hauteur	L (min)	L (max)
<b>220cm</b>	205cm	245 cm
<b>225cm</b>	210 cm	250 cm
<b>230cm</b>	215 cm	255 cm
<b>235cm</b>	220 cm	260 cm
<b>240cm</b>	225 cm	265 cm
<b>245cm</b>	230 cm	270 cm
<b>250cm</b>	235 cm	275 cm

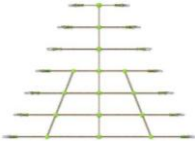

		<b>SPIDER</b> J-900550
121 306 TH Ø6x45		28
121 602 Ø6		28
122 023		14
122 025		14
122 559		1

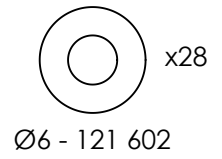
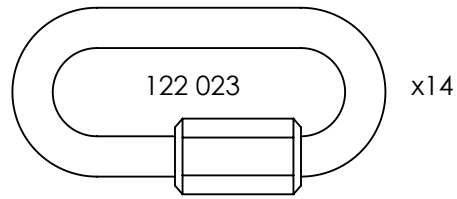
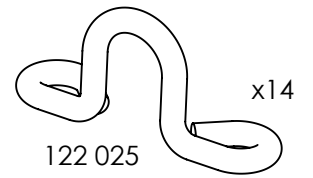
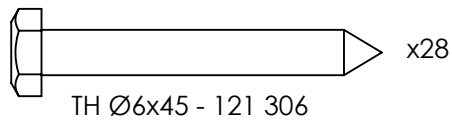
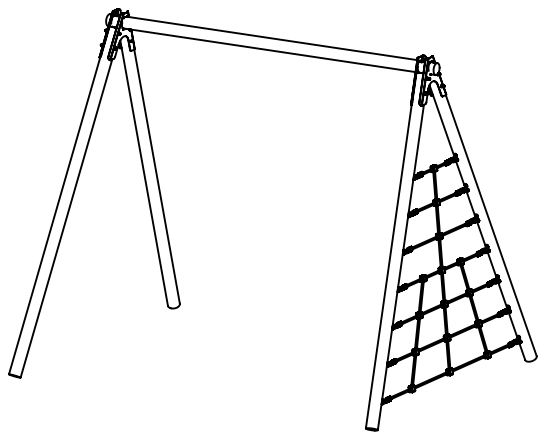

1

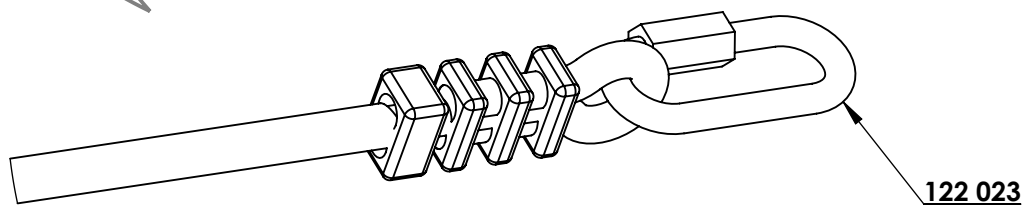
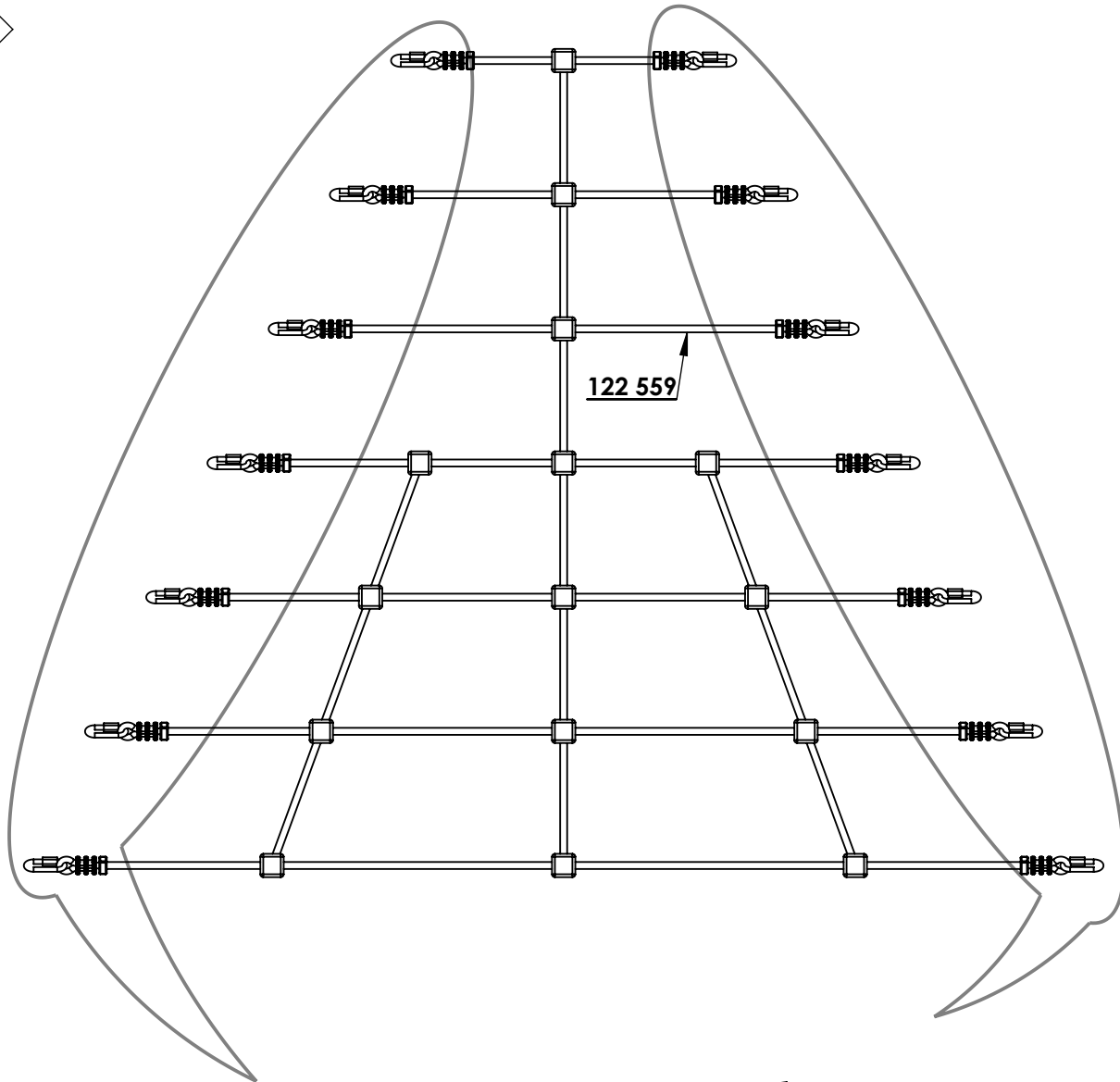

2

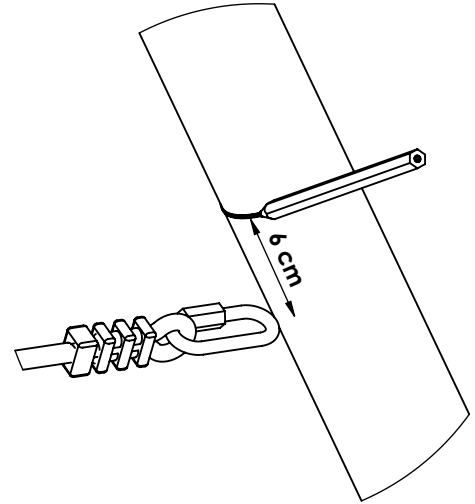
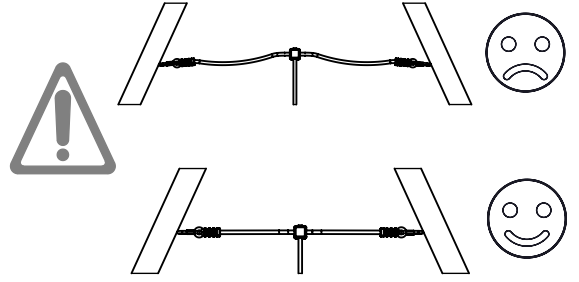
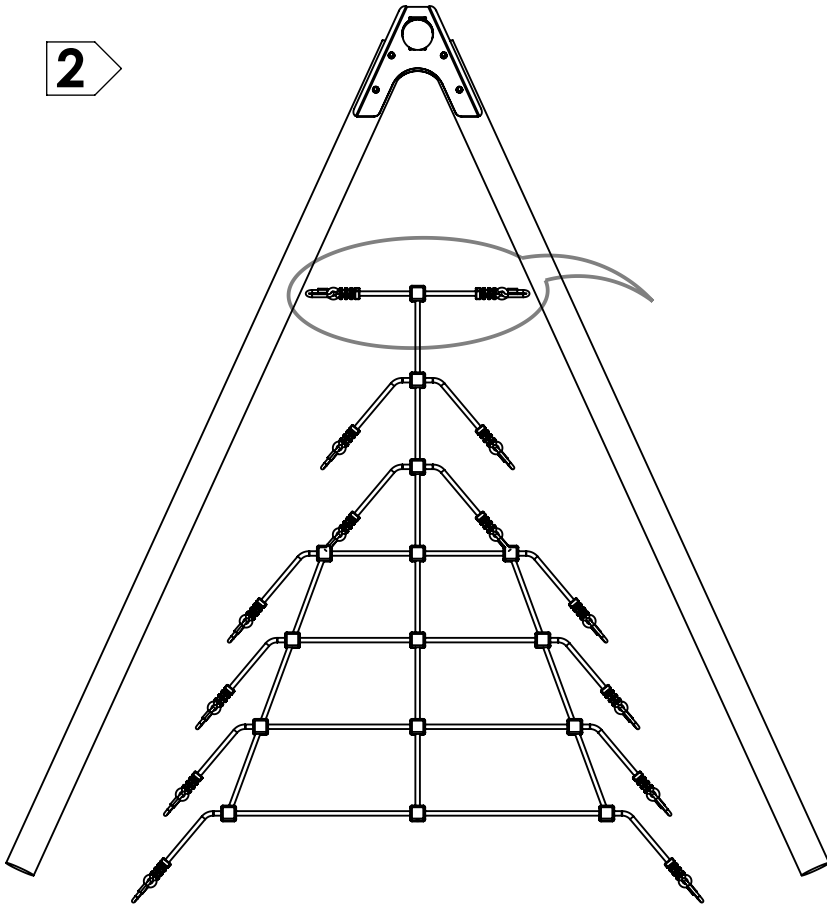

3

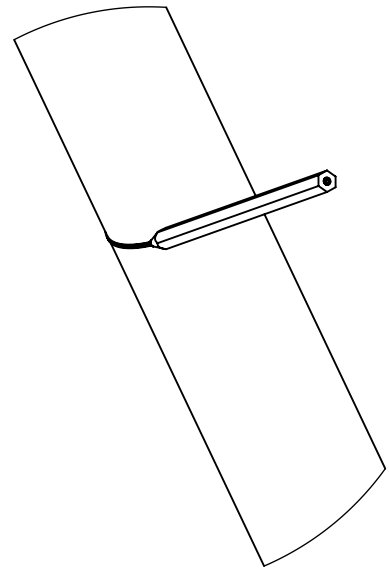
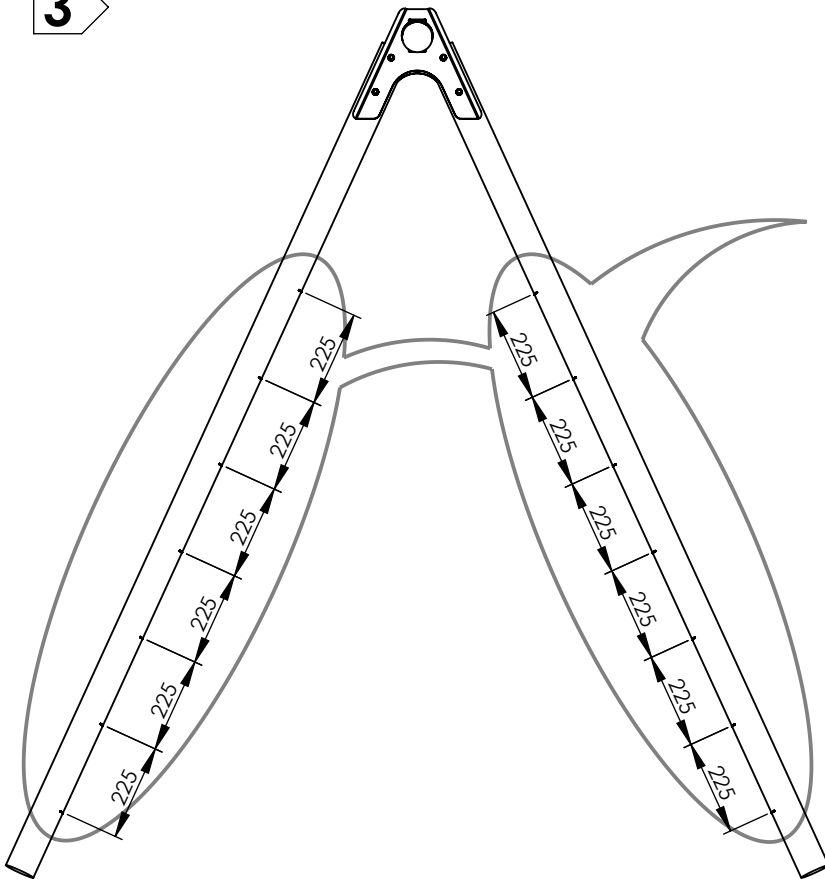

4

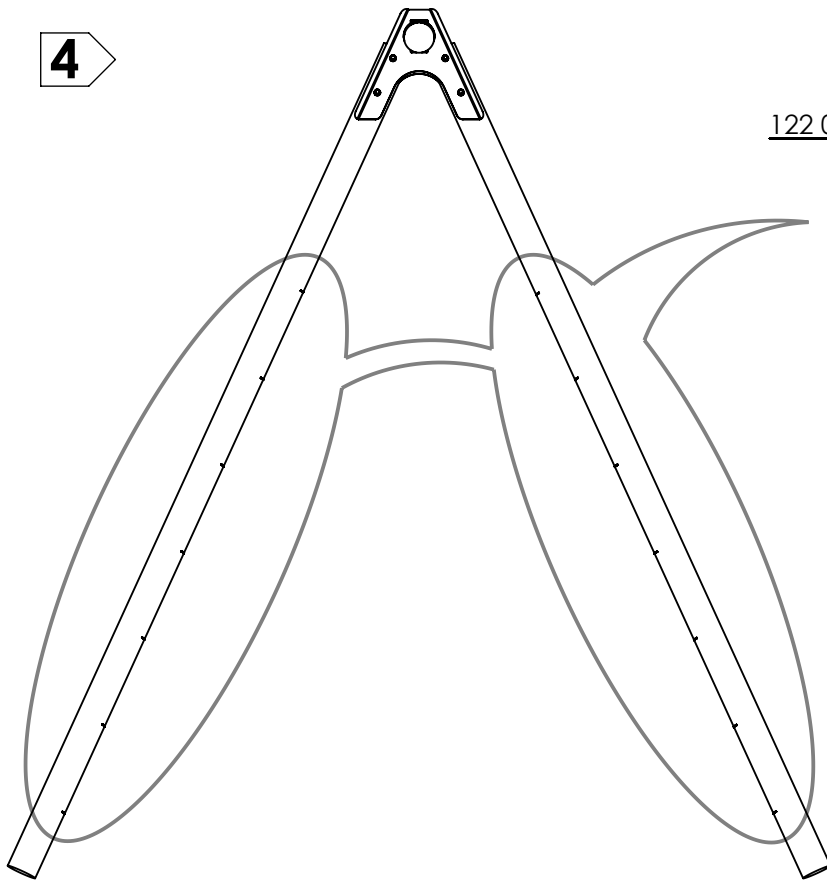

122 025

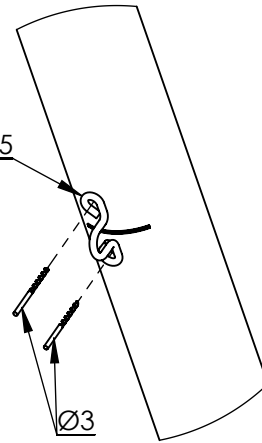

$\varnothing 6$   
121 602  
TH  $\varnothing 6 \times 45$   
121 306

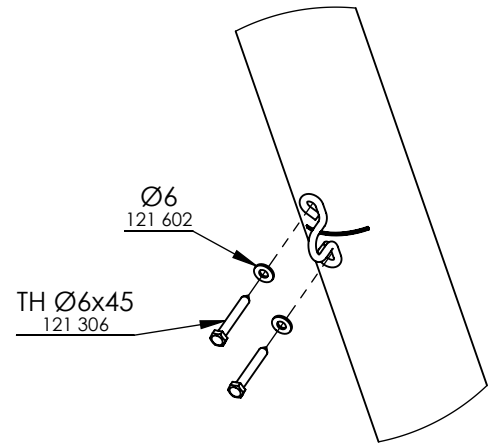

5

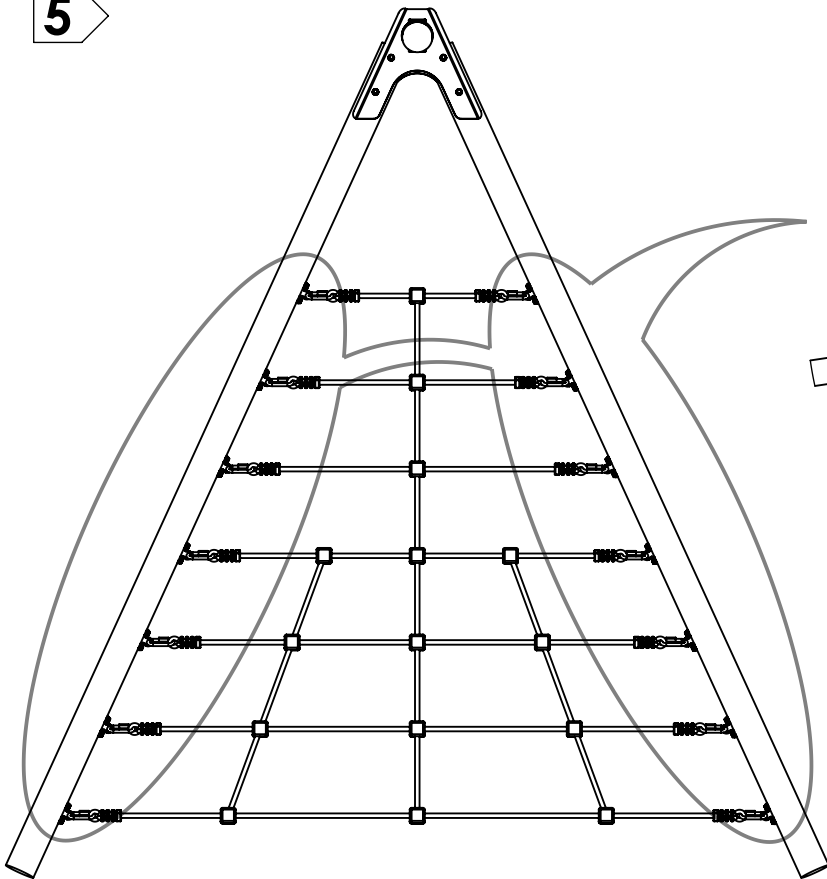

122 023

