

EAN :3276000441922

Ref: OS7979

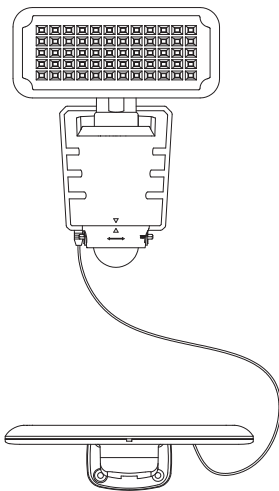

2/2



2023-06-V01

FR Manuel d'Instructions

EL Εγχειρίδιο Οδηγιών

BR Manual de Instrução

ES Manual de Instrucciones

PL Instrukcja Obsługi

DE Anleitung Handbuch

PT Manual de Instruções

UA Інструкція з Експлуатації

EN Instructions Manual

IT Manuale di Istruzioni

RO Manual de Instrucțiuni



FR : Montage / ES: Montaje / PT: Montagem / IT: Montaggio / EL: Συναρμολόγηση /
 PL: Montaż / UA: Збірка / RO: Montaj / BR: Montagem / DE: Montage / EN: Assembly



4 → 5



FR: Utilisation / ES: Utilización / PT: Utilização / IT: Uso / EL: Χρήση / PL: Użytkowanie
 / UA: Використання / RO: Utilizare / BR: Utilização / DE: Verwenden Sie / EN: Use



6 → 8

**FR: CARACTÉRISTIQUES TECHNIQUES / ES: CARACTERÍSTICAS TÉCNICAS / PT: CARACTERÍSTICAS TÉCNICAS /
 IT: CARATTERISTICHE TECNICHE / EL: ΤΕΧΝΙΚΑ ΧΑΡΑΚΤΗΡΙΣΤΙΚΑ / PL: DANE TECHNICZNE / UA: ТЕХНІЧНІ
 ХАРАКТЕРИСТИКИ / RO: CARACTERISTICI TEHNICE / BR: CARACTERÍSTICAS TÉCNICAS / DE: TECHNISCHE
 CHARAKTERISTIKA / EN: TECHNICAL CHARACTERISTICS**



A1.



A4.



A6.



A7.



A13.



A17.



A20.



A32.



A37.



E1.



E2.



T3.

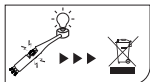

T9.



T11.



T12.

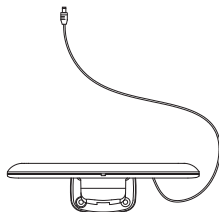
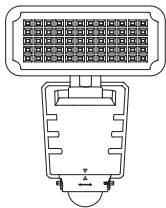

A
x6



B
x6

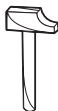
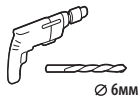



1

1

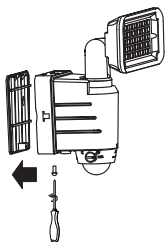

2

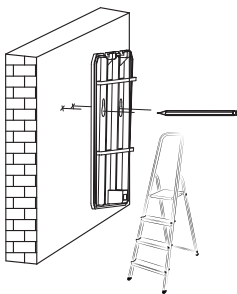

2

3

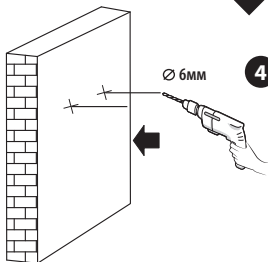

4

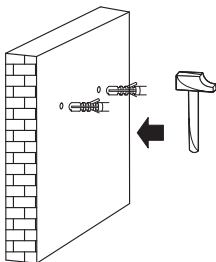

3

5

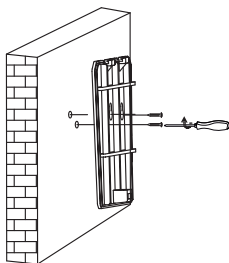

6

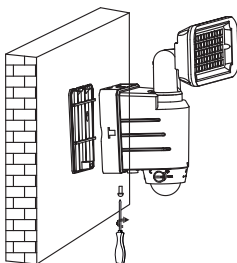

4

7

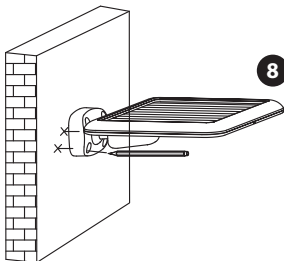

8

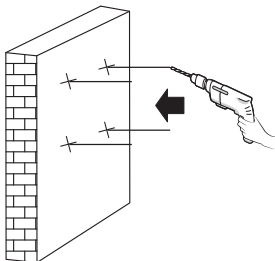

5

9

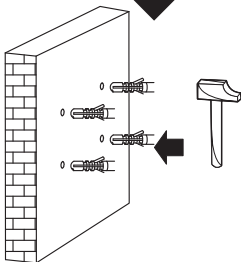

*



+



*Utiliser les vis et chevilles adaptées à votre support - Utilice tornillos y tacos adecuados para el soporte - Utilize buchas e parafusos adaptados à superfície de instalação - Utilizzare viti e tasselli adeguati al proprio supporto - Χρησιμοποιήστε τις κατάλληλες βίδες και ούλα για τον τοίχο σας - Taşınucua uygun vida ve dübel kullanın - Используйте шурупы/крепления, которые подходят к основанию, к которому они будут крепиться - Використовуйтевинти та штифти, що підходять для поверхні, на яку Ви монтуєте рошет/жалюзі - Należy korzystać ze śrub i kołków przystosowanych do nośnika - Utilizați șuruburile și diblurile adecvate suportului dvs - Use screws and dowels suited to your backing.

6

10

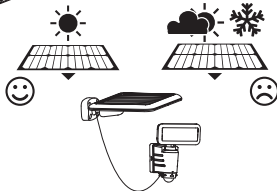
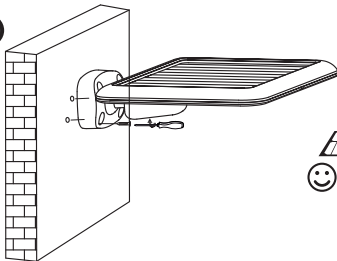



1

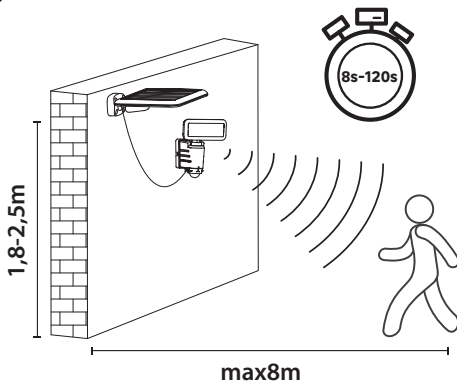

2

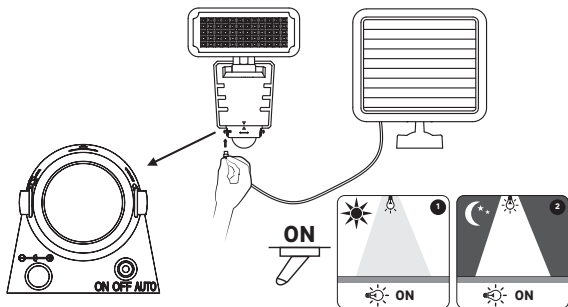

3

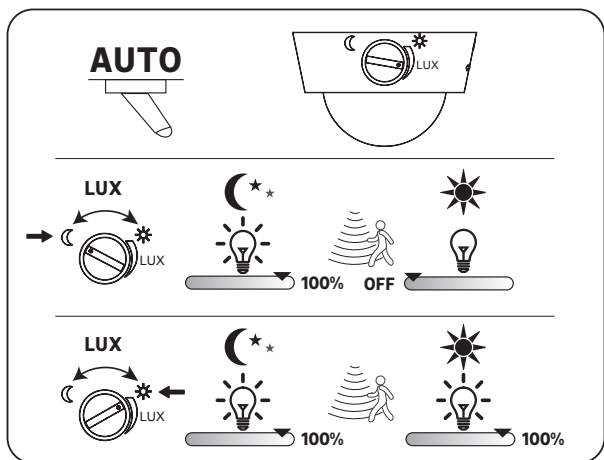
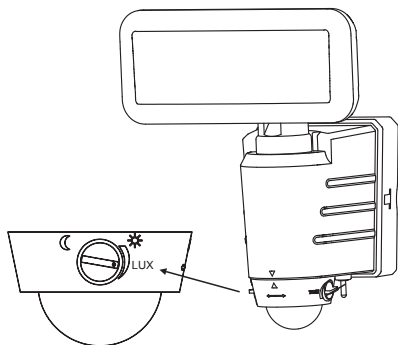

4

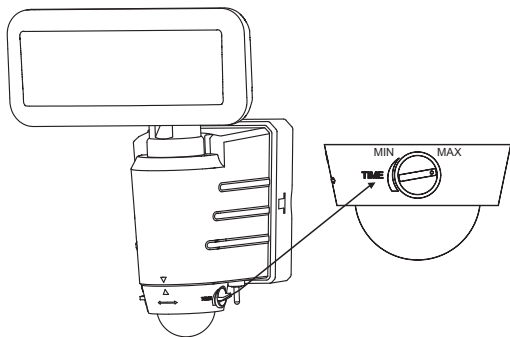

AUTO

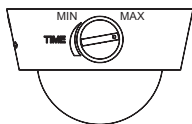

5

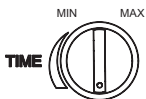
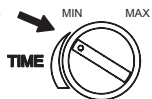



- FR** Ce produit est recyclable. S'il ne peut plus être utilisé, veuillez l'apporter dans un centre de recyclage de déchets.
- ES** Este producto es reciclable. Si ya no se puede usar, llévelo a un centro de reciclaje de residuos.
- PT** Este produto é reciclável. Se deixar de o utilizar, entregue-o num centro de reciclagem de resíduos.
- IT** Questo prodotto può essere riciclato. Se deve essere smaltito, portalo presso un centro di riciclaggio.
- EL** Αυτό το προϊόν είναι ανακυκλώσιμο. Εάν δεν μπορεί πλέον να χρησιμοποιηθεί, μεταφέρετε την σε κάποιο κέντρο ανακύκλωσης απορριμμάτων.
- PL** Ten produkt poddawany jest recyklingowi, a kiedy przestaje być użyteczny należy dostarczyć go do punktu zbiórki odpadów.
- UA** Цей продукт може перероблятися. Якщо воно більше не є придатне для використання, здайте його в утилізаційний центр.
- RO** Acest produs este reciclabil. Dacă nu mai poate fi folosit, vă rugăm să îl aduceți într-un centru de reciclare a deșeurilor.
- BR** Este produto é reciclável. Se não puder mais ser usado, descarte em um centro de reciclagem de resíduos.
- DE** Dieses Produkt ist recycelbar. Wenn es nicht mehr verwendet werden kann, bringen Sie es bitte zum Recycling-Center.
- EN** This product is recyclable. If it cannot be used anymore, please take it to waste recycling centre.



FR Traduction de la version originale du mode d'emploi / ES Traducción de las Instrucciones originales / PT Tradução das Instruções Originais / IT Traduzione delle istruzioni originali / EL Μετάφραση των πρωτότυπων οδηγιών / PL Tłumaczenie instrukcji oryginalnej / UA Переклад оригінальної інструкції / RO Traducerea instrucțiunilor originale / BR Tradução das Instruções Originais / DE Übersetzung der Originalversion der Gebrauchsanweisung / Original Instructions.

Made in China

Країна походження: Китай

EU ADEO Services - 135 Rue Sadi Carnot - CS00001 - 59790 RONCHIN - FRANCE

UA Виробник: ТОВ "Адео Сервісес С.А.", вул. Саді Карно, CS 00001, 59790 Роншен, Франція.
Імпортер: ТОВ "Леруа Мерлен Україна", 04201 Україна, м. Київ, вул. Полярна 17А, +380 44 498 46 00. Імпортер приймає претензії від споживачів щодо товару, а також проводить його ремонт, технічне і гарантійне обслуговування

BR LEROY MERLIN COMPANHIA BRASILEIRA DE BRICOLAGEM
CNPJ: 01.438.784/0001-05
Rua Pascoal Pais, nº. 525, 6º andar cj 61 a 64, Vila Cordeiro, São Paulo - SP. CEP: 04581-060
CALM (Central de Atendimento Leroy Merlin) Capitais
4020-5376 Demais Regiões 0800-0205376

ZA Imported by Adeo South Africa (PTY) LTD T/A Leroy Merlin,
Hosted in Leroy Merlin Fourways Store 35 Roos Street, Witkoppen
Ext 97, Sandton, 2191 Johannesburg, Gauteng, South Africa.
Tel: +27 10 493 8000 Email: contact@leroymerlin.co.za.