

EAN CODE : 3276000592228

**FR** Manuel d'Instructions

**ES** Manual de Instrucciones

**PT** Manual de Instruções

**IT** Manuale di Istruzioni

**EL** Εγχειρίδιο Οδηγιών

**PL** Instrukcja Obsługi

**RU** Руководства по  
Эксплуатации

**KZ** Пайдаланушы Нұсқаулығы

**UA** Інструкція з Експлуатації

**RO** Manual de Instrucțiuni

**BR** Manual de Instruções

**EN** Instructions Manual

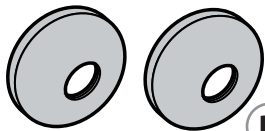
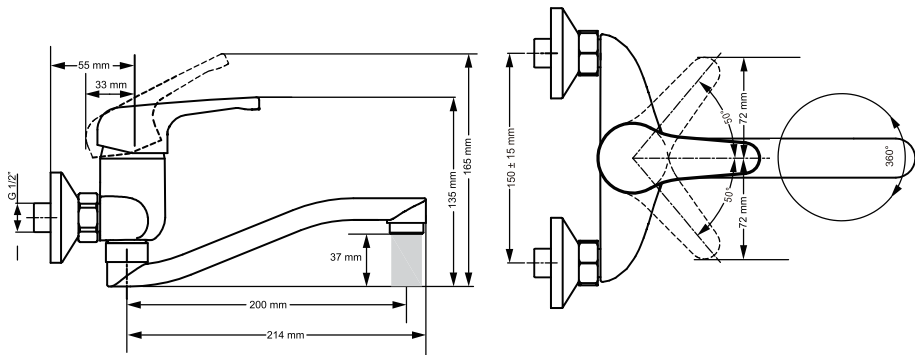

A

B

C

D

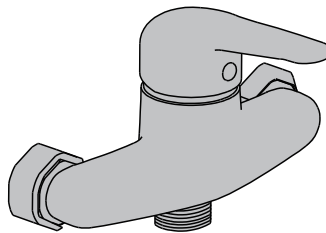

E

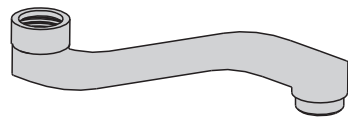

MIN.35 mm

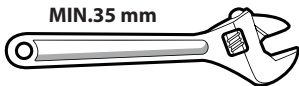



**FR:** Préparation / **ES:** Preparación / **PT:** Preparação / **IT:** Preparazione / **EL:** Προετοιμασία /  
**PL:** Przygotowanie / **RU:** Подготовка / **KZ:** Дайындау / **UA:** Підготування / **RO:** Pregătire / **BR:** Preparação /  
**EN:** Preparation



**FR:** Montage / **ES:** Montaje / **PT:** Montagem / **IT:** Montaggio / **EL:** Συναρμολόγηση /  
**PL:** Montaż / **RU:** Сборка / **KZ:** Монтаждау / **UA:** Збірка / **RO:** Montaj / **BR:** Montagem /  
**EN:** Assembly



**FR:** Utilisation eau chaude-eau froide/ **ES:** Utilización agua caliente-agua fría/ **PT:** Utilização água quente-água fria/  
**IT:** Uso acqua calda-acqua fredda/ **EL:** Χρήση ζεστού-κρύου νερού/ **PL:** Użytkowanie zimnej wody-gorącej wody/  
**RU:** Використання гарячої води/ **UA:** води - холодної води/ **RO:** Utilizare apă caldă-apă rece/  
**EN:** Using hot and cold water



**FR:** Changement de cartouche/ **ES:** Cambio de cartucho/ **PT:** Mudança de cartucho/ **IT:** Cambio cartuccia/  
**EL:** Αλλαγή φυσιγγίου/ **PL:** Wymiana wkładu / **RU:** Смена картриджа/ **UA:** Заміна картриджа/  
**RO:** Schimbare cartuş/ **EN:** Replacing the cartridge



**FR:** Changement de mousseur/ **ES:** Cambio de aireador/ **PT:** Mudança de arejador/ **IT:** Cambio rompigetto/  
**EL:** Αλλαγή αεράτορα / **PL:** Wymiana perlatora / **RU:** Смена аэратора / **UA:** Заміна аератора/  
**RO:** Schimbare aerator/ **EN:** Replacing the aerator





FR: Préparation / ES: Preparación / PT: Preparação / IT: Preparazione / EL: Προετοιμασία /  
PL: Przygotowanie / RU: Подготовка / KZ: Дайындау / UA: Підготування / RO: Pregătire /  
BR: Preparação / EN: Preparation

1

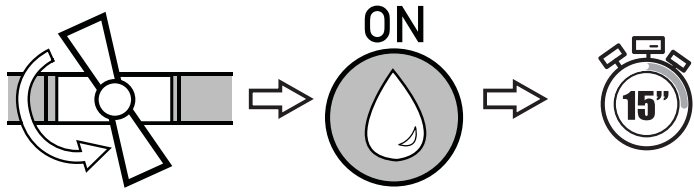

2

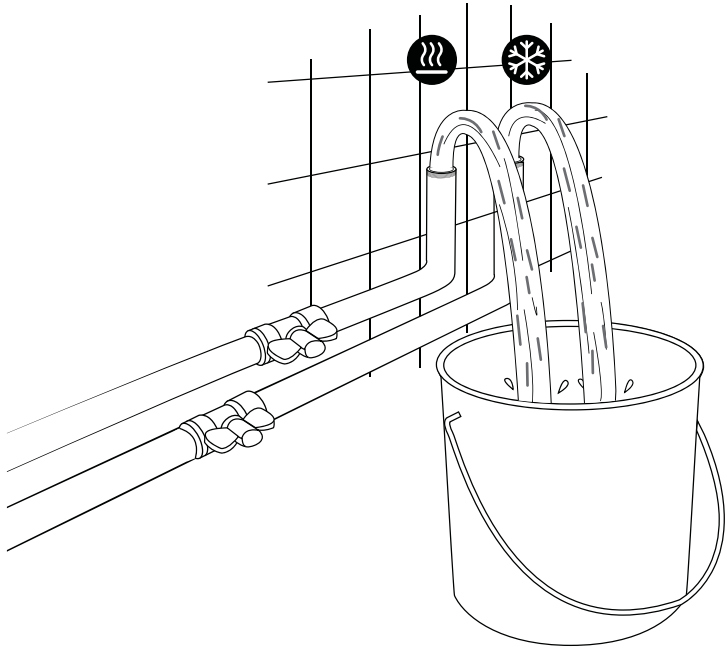

3

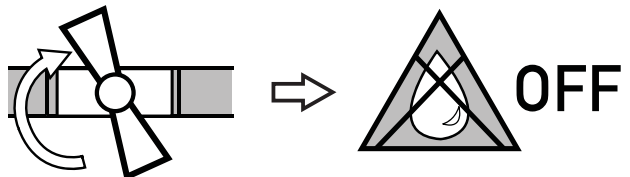



FR: Montage / ES: Montaje / PT: Montagem / IT: Montaggio / EL: Συναρμολόγηση /  
PL: Montaż / RU: Сборка / KZ: Монтаждау / UA: Збірка / RO: Montaj / BR: Montagem /  
EN: Assembly

1



B

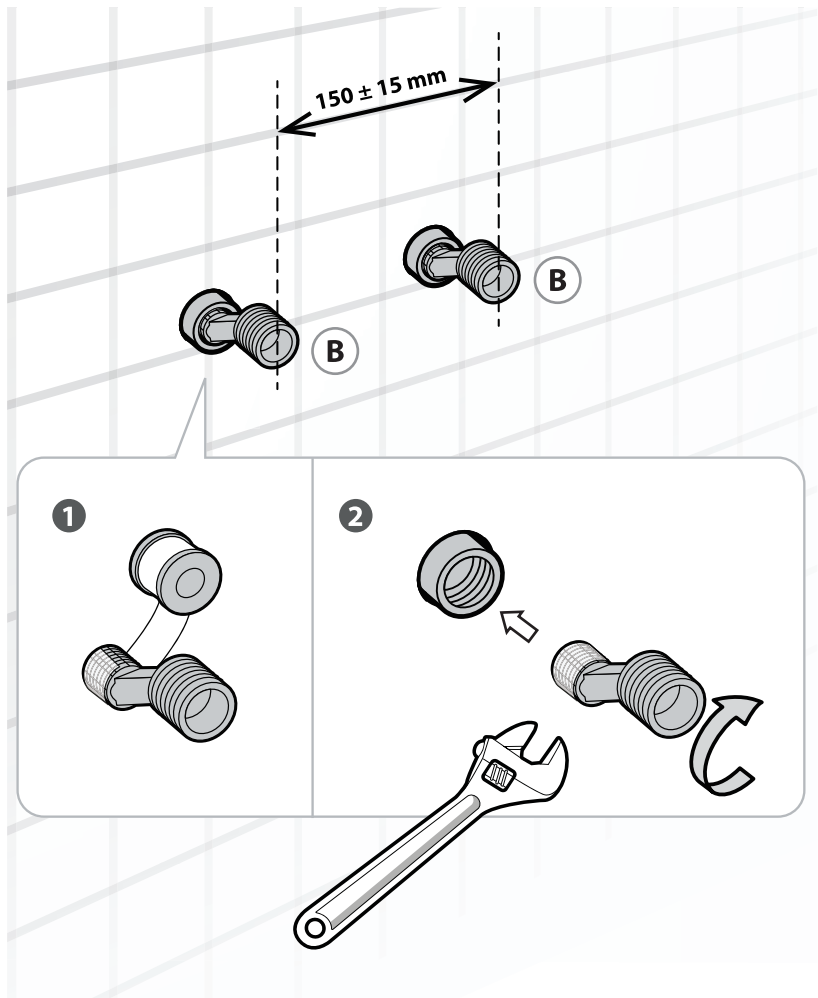

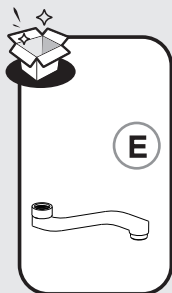

FR: Montage / ES: Montaje / PT: Montagem / IT: Montaggio / EL: Συναρμολόγηση /  
PL: Montaż / RU: Сборка / KZ: Монтаждау / UA: Збірка / RO: Montaj / BR: Montagem /  
EN: Assembly

1

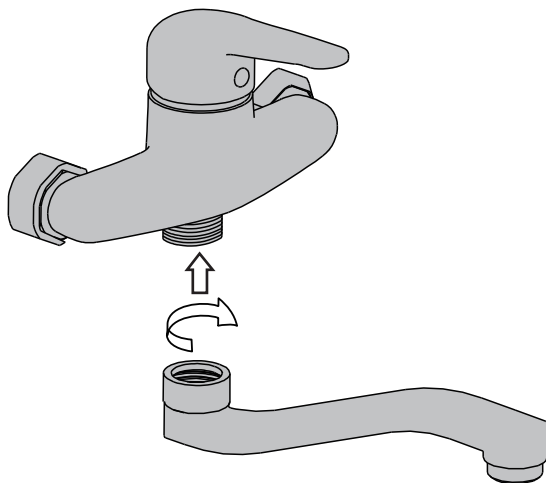



2

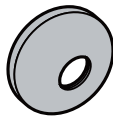
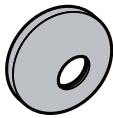

D

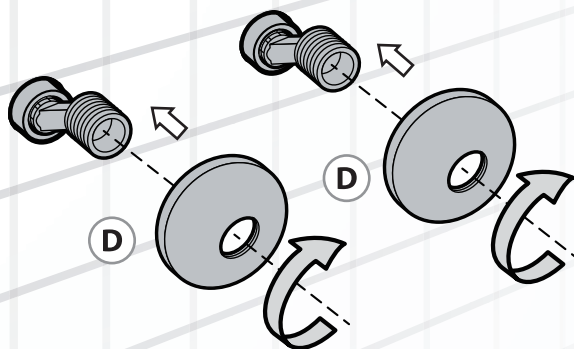



3

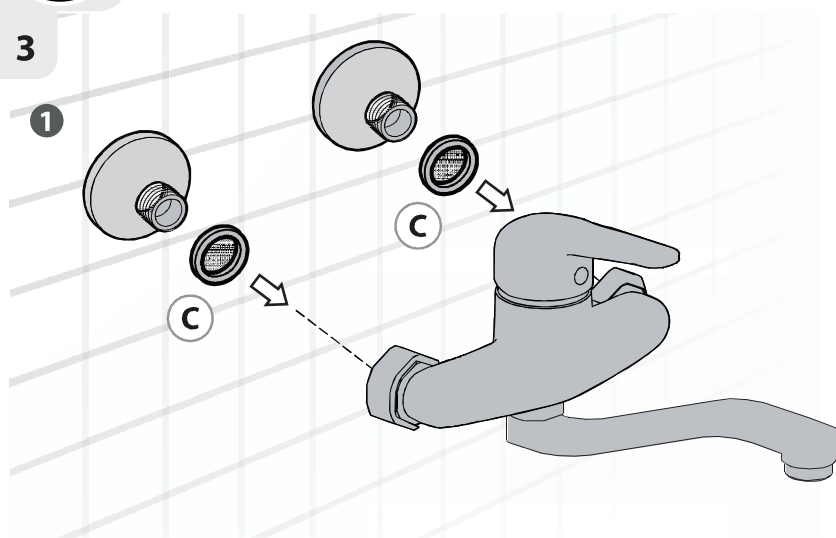

2

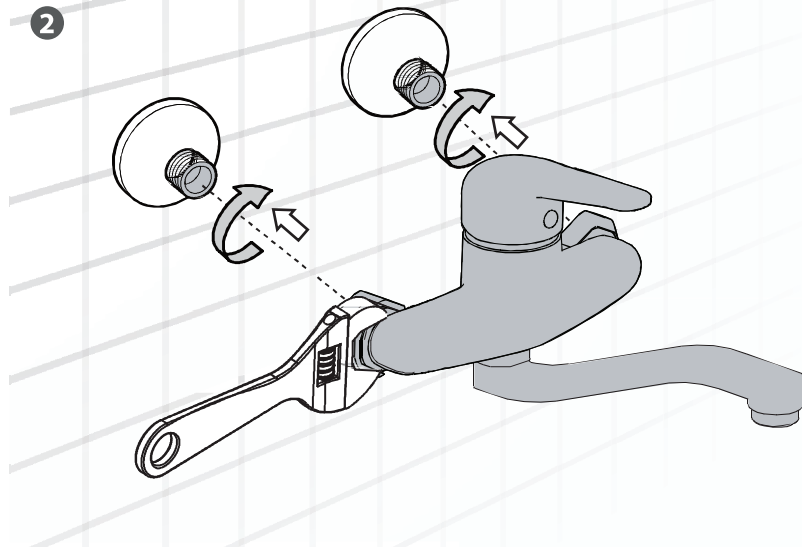

3

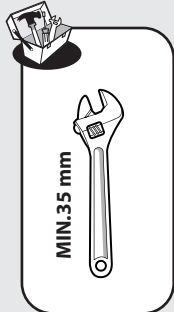
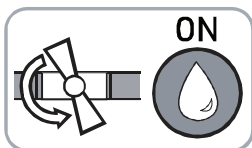

MIN. 35 mm

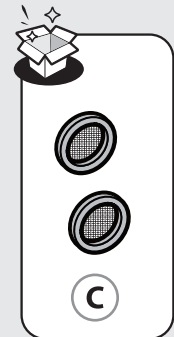

C





4

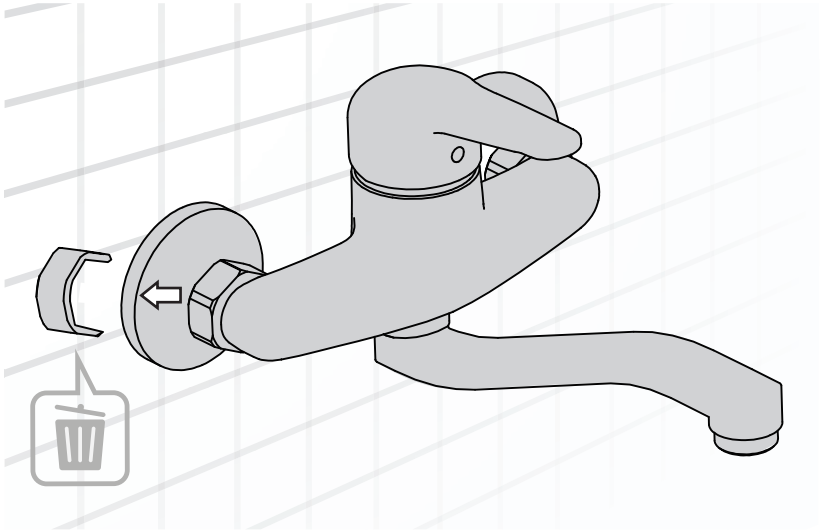



**FR:** Utilisation eau chaude-eau froide/ **ES:** Utilización agua caliente-agua fría/ **PT:** Utilização água quente-água fria/  
**IT:** Uso acqua calda-acqua fredda/ **EL:** Χρήση ζεστού-κρύου νερού/ **PL:** Użytkowanie zimnej wody-gorącej wody/  
**RU:** Використання гарячої води/ **KZ:** Суық және ыстық суды қолдану/ **UA:** води - холодної води/  
**RO:** Utilizare apă caldă-apă rece/ **BR:** Uso de água quente e fria/ **EN:** Using hot and cold water

1

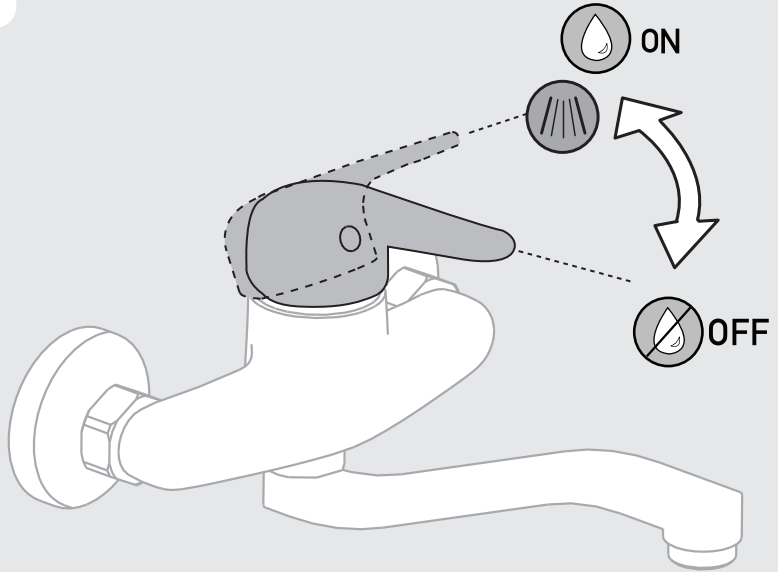
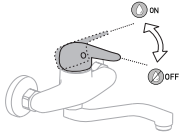

2

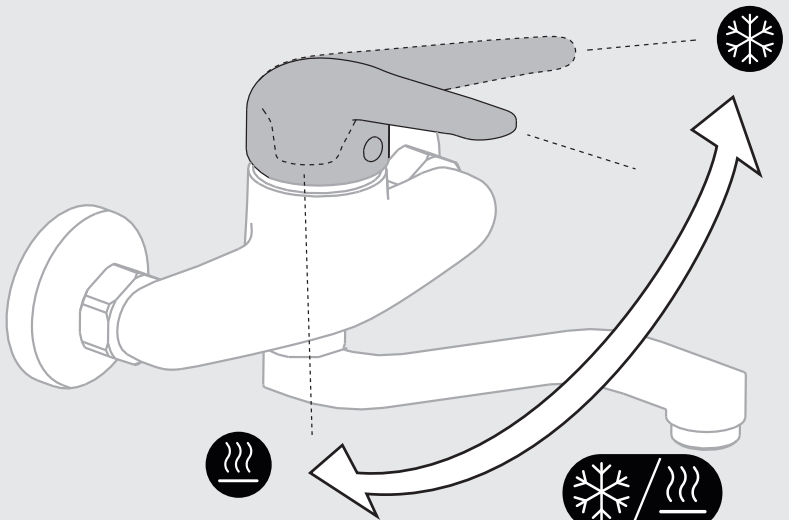

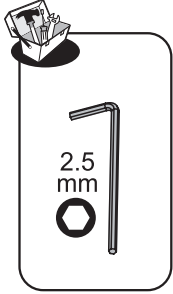

FR: Changement de cartouche/ ES: Cambio de cartucho/ IT: Cambio cartuccia/ PT: Mudança de cartucho/  
EL: Αλλαγή φυσιγγίου/ PL: Wymiana wkładu / RU: Смена картриджа/ KZ: Картриджді ауыстыру/  
UA: Заміна картриджа/ RO: Schimbare cartuş/ BR: Substituição de cartucho/ EN: Replacing the cartridge

1



OFF

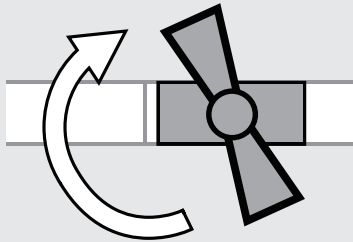

2

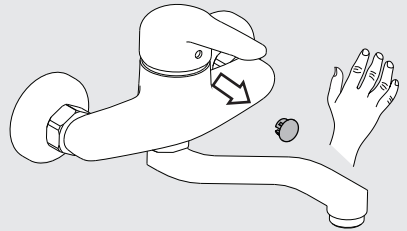

3

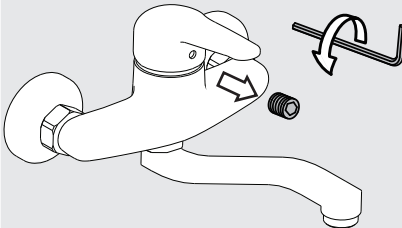

4

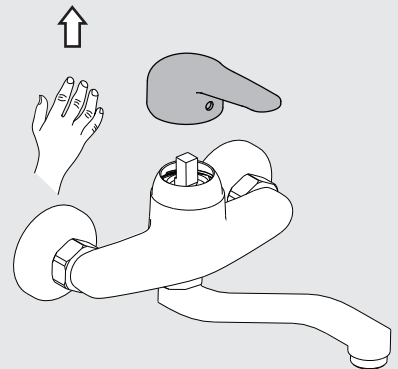

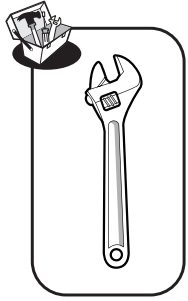

**FR:** Changement de cartouche/ **ES:** Cambio de cartucho/ **IT:** Cambio cartuccia/ **PT:** Mudança de cartucho/  
**EL:** Αλλαγή φουσιγγίου/ **PL:** Wymiana wkładu / **RU:** Смена картриджа/ **KZ:** Картриджді ауыстыру/  
**UA:** Заміна картриджа/ **RO:** Schimbare cartuş/ **BR:** Substituição de cartucho/ **EN:** Replacing the cartridge

5

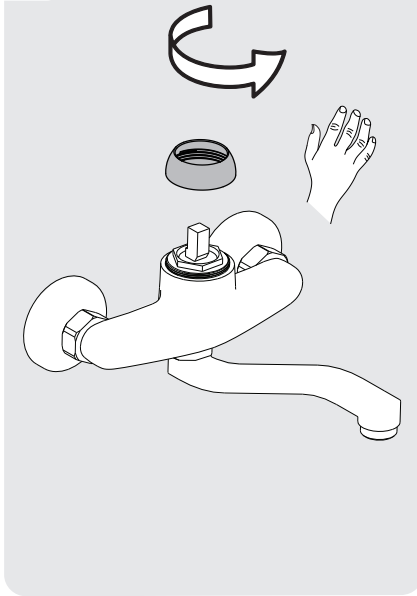

6

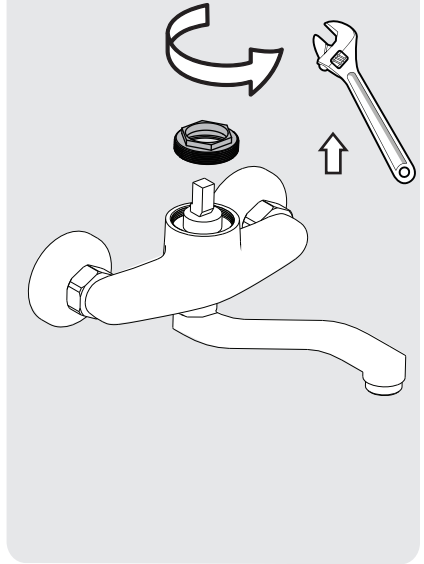

7

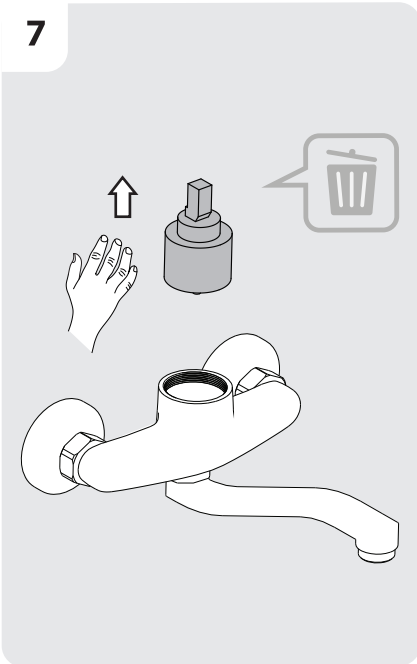

8

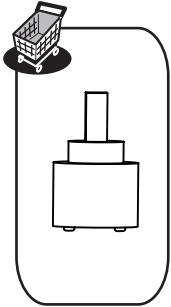
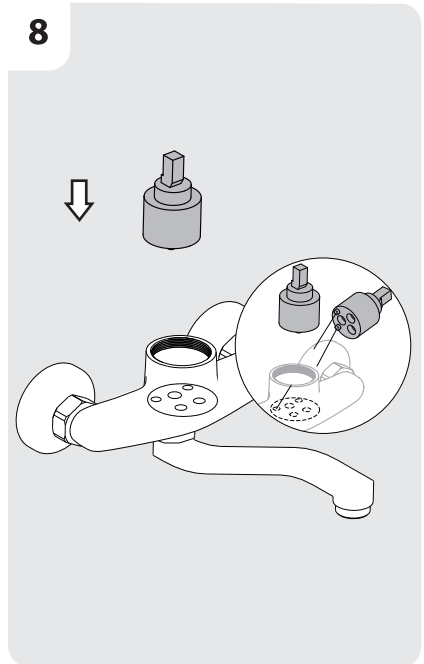

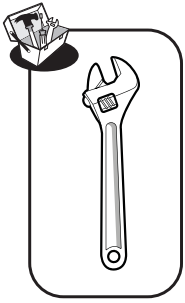

**FR:** Changement de cartouche/ **ES:** Cambio de cartucho/ **IT:** Cambio cartuccia/ **PT:** Mudança de cartucho/  
**EL:** Αλλαγή φουσιγγίου/ **PL:** Wymiana wkładu / **RU:** Смена картриджа/ **KZ:** Картриджді ауыстыру/  
**UA:** Заміна картриджа/ **RO:** Schimbare cartuş/ **BR:** Substituição de cartucho/ **EN:** Replacing the cartridge

9

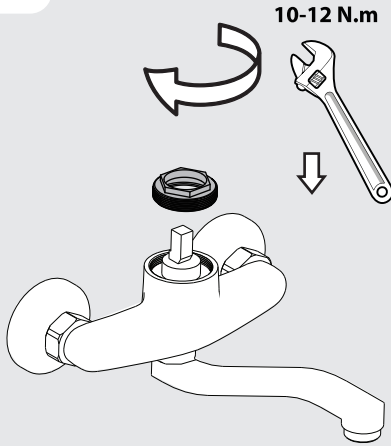

10

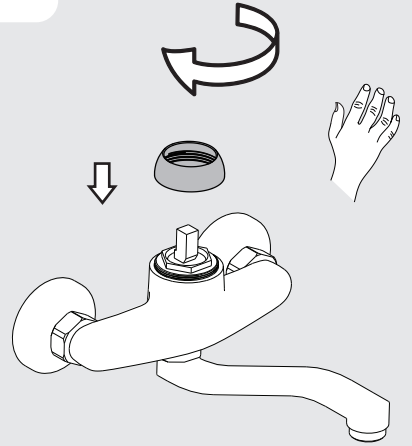

11

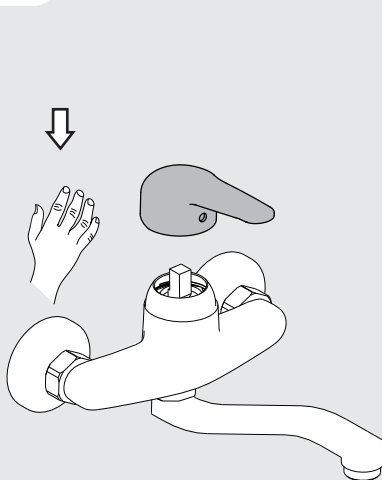

12

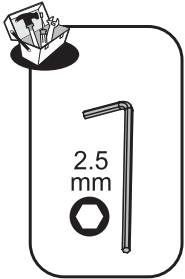
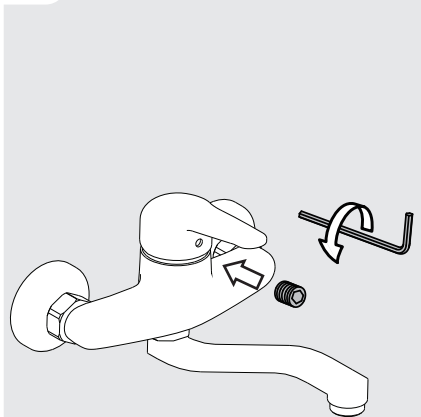

2.5  
mm



**FR:** Changement de cartouche/ **ES:** Cambio de cartucho/ **IT:** Cambio cartuccia/ **PT:** Mudança de cartucho/  
**EL:** Αλλαγή φουσιγγίου/ **PL:** Wymiana wkładu / **RU:** Смена картриджа/ **KZ:** Картриджді ауыстыру/  
**UA:** Заміна картриджа/ **RO:** Schimbare cartuş/ **BR:** Substituição de cartucho/ **EN:** Replacing the cartridge

**13**

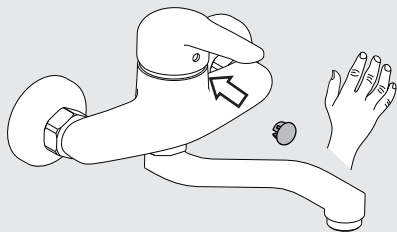

**14**

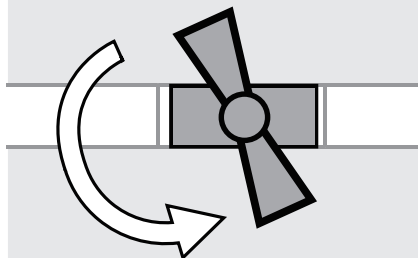

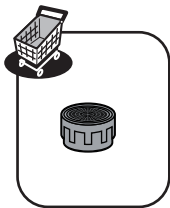

FR: Changement de mousseur/ ES: Cambio de aireador/ PT: Mudança de arejador/ IT: Cambio rompigoetto/  
 EL: Αλλαγή αεράτορα / PL: Wymiana perlatora / RU: Смена аэратора/ KZ: Ауақанықтырғышты ауыстыру/  
 UA: Заміна аератора/ RO: Schimbare aerator/ BR: Substituição do aerador/ EN: Replacing the aerator

1

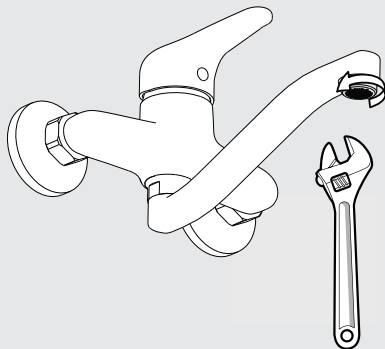

2

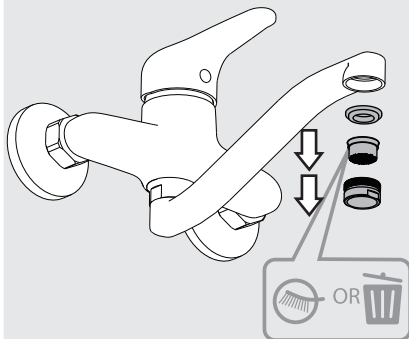

- |   |              |                |             |
|---|--------------|----------------|-------------|
|  | FR Nettoyage | EL Καθαρισμός  | UA Очищення |
|   | ES Limpieza  | PL Czyszczenie | RO Curățare |
|   | PT Limpeza   | RU Чистка      | BR Limpeza  |
|   | IT Pulizia   | KZ тазарту     | EN Cleaning |

3

- |             |          |             |            |
|-------------|----------|-------------|------------|
| FR Vinaigre | IT Aceto | RU Уксус    | RO Oțet    |
| ES Vinagre  | EL Ξύδι  | KZ Сірке су | BR Vinagre |
| PT Vinagre  | PL Ocet  | UA Оцет     | EN Vinegar |

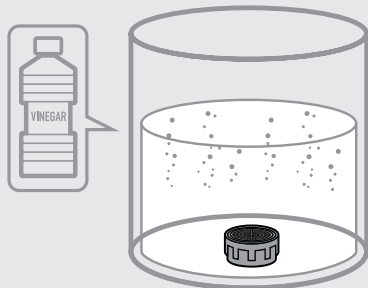

4

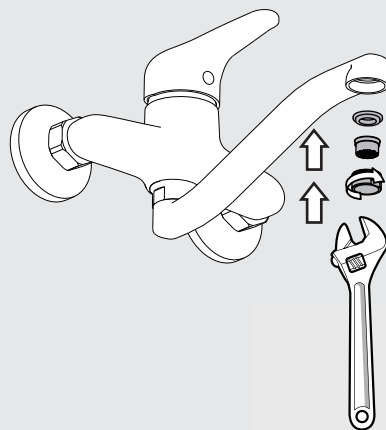



Eau claire / Agua limpia / Água limpa / Acqua pulita / Καθαρό νερό / Czysta woda / Чистая вода / Água limpa /  
Чиста вода / Ara curata / таза су / Clean water



Sans solvant / Sin disolvente / Sem solventes / Senza solventi / Χωρίς διαλυτικά / Bez rozpuszczalnika / Без растворителя /  
Sem solventes / Без розчинника / Fara solvent / еріткішчиз / Solvent-free

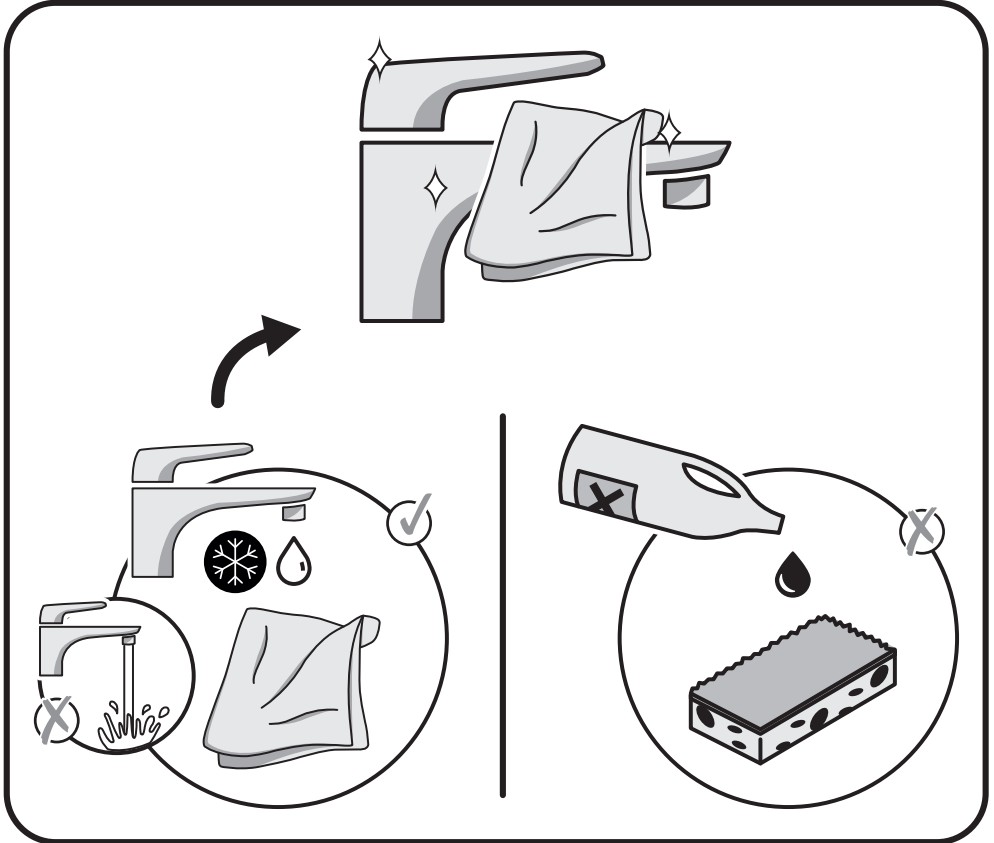



NO	DESCRIPTION	CODE NO	QTY	REMARK
1	Handle	25	1	
2	Beautify Cover	603087 CR	1	
3	Pressing Nut	604118 BC	1	
4	Cartridge	SN-40 S/D THEDRA	1	
5	Mixer Body	60255-01	1	
6	Spout	60255-002	1	
7	Aerator	40.2103.000	1	
8	Aerator Shell	301001 CR	1	
9	Fixing pack	T-23	2	

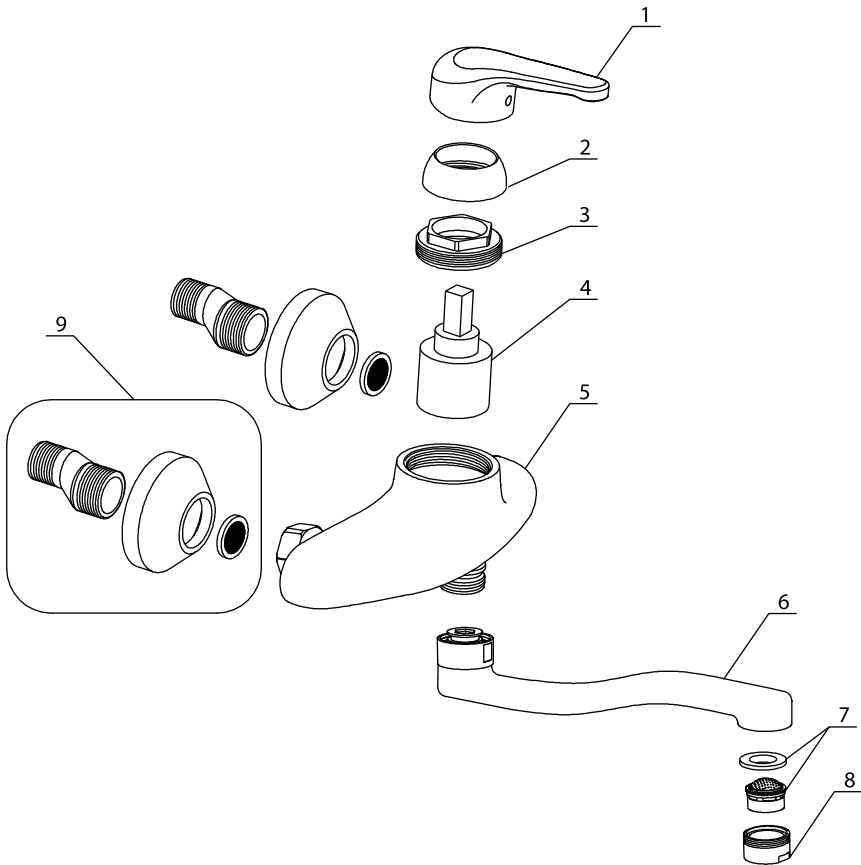







Certificado de conformidad sanitaria.  
Atestado de conformidade sanitária.  
certificato di conformità sanitaria.  
Βεβαίωση υγειονομικής συμμόρφωσης.  
Certyfikat zgodności sanitarnej.  
Декларация о соответствии санитарным нормам  
Санитарлық талаптарға сәйкестік декларациясы  
Декларація про відповідність санітарним нормам  
Atestat de conformitate sanitară  
Certificado de conformidade sanitária.  
Declaration of sanitary conformity.  
Attestation de conformité sanitaire

\* Garantie 10 ans / 10 años de garantía / Garantia de 10 años / Garanzia 10 Anni / Εγγύηση 10 ετών / Gwarancja 10-letnia / Гарантия 10 года / Кепілдік 10 жыл / Гарантія 10 років /  
Garantje 10 ani / 10 anos de garantia / 10-year guarantee

Made in P.R.C 2018

ADEO Services - 135 Rue Sadi Carnot - CS 00001  
59790 RONCHIN - France



ТОВ «Леруа Мерлен Україна»,  
вул. Полярна 17а, м. Київ 04201, Україна

