

**delinia**

Guarantee  
**10**  
years

**NATU**

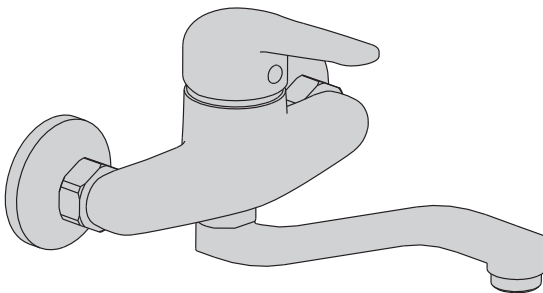

EAN CODE : 3276000592228

**FR** Manuel d'Instructions

**ES** Manual de Instrucciones

**PT** Manual de Instruções

**IT** Manuale di Istruzioni

**EL** Εγχειρίδιο Οδηγιών

**PL** Instrukcja Obsługi

**RU** Руководство по  
Эксплуатации

**KZ** Пайдаланушы Нұсқаулығы

**UA** Інструкція з Експлуатації

**RO** Manual de Instrucțiuni

**BR** Manual de Instruções

**EN** Instructions Manual

2018/11-102

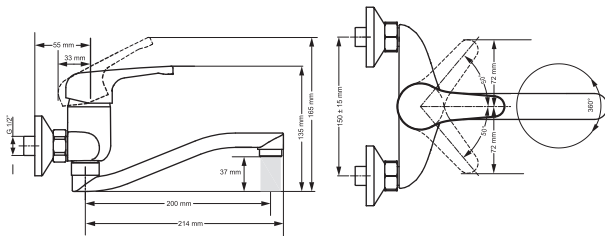

B



C

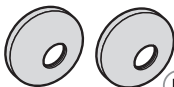

D

A

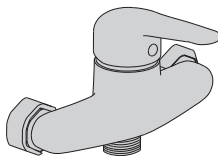

E

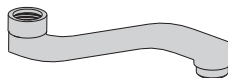

MIN.35 mm

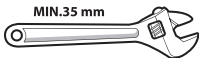



FR: Préparation / ES: Preparación / PT: Preparação / IT: Preparazione / EL: Προετοιμασία /  
PL: Przygotowanie / RU: Подготовка / KZ: Дайындау / UA: Підготування / RO: Pregătire / BR: Preparação /  
EN: Preparation



FR: Montage / ES: Montaje / PT: Montagem / IT: Montaggio / EL: Συναρμολόγηση /  
PL: Montaż / RU: Сборка / KZ: Монтаждау / UA: Збірка / RO: Montaj / BR: Montagem /  
EN: Assembly



FR: Utilisation eau chaude-eau froide/ ES: Utilización agua caliente-agua fría/ PT: Utilização água quente-água fria/  
IT: Uso acqua calda-acqua fredda/ EL: Χρήση ζεστού-κρύου νερού/ PL: Użytkowanie zimnej wody-gorącej wody/  
RU: Использование горячей и холодной воды/ UA: використання гарячої - холодної води/  
RO: Utilizare apă caldă-apă rece/ EN: Using hot and cold water



FR: Changement de cartouche/ ES: Cambio de cartucho/ PT: Mudança de cartucho/ IT: Cambio cartuccia/  
EL: Αλλαγή φυσιγγίου/ PL: Wymiana wkładu / RU: Смена картриджа/ UA: Заміна картриджа/  
RO: Schimbare cartus/ EN: Replacing the cartridge

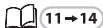

FR: Changement de mousseur/ ES: Cambio de aireador/ PT: Mudança de arejador/ IT: Cambio rompigetto/  
EL: Αλλαγή αεράτορα / PL: Wymiana perlatora / RU: Смена аэратора/ UA: Заміна аератора/  
RO: Schimbare aerator/ EN: Replacing the aerator





FR: Préparation / ES: Preparación / PT: Preparação / IT: Preparazione / EL: Προετοιμασία /  
PL: Przygotowanie / RU: Подготовка / KZ: Дайындау / UA: Підготовка / RO: Pregătire /  
BR: Preparação / EN: Preparation

1

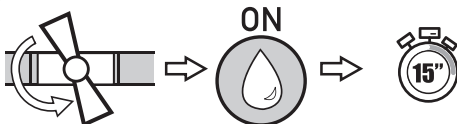

2

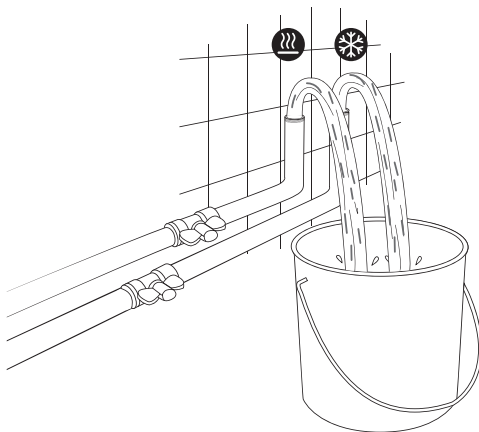

3

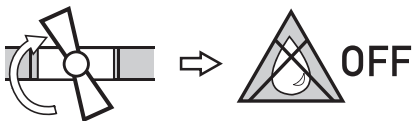



B



FR: Montage / ES: Montaje / PT: Montagem / IT: Montaggio / EL: Συναρμολόγηση /  
PL: Montaż / RU: Сборка / KZ: Монтаждау / UA: Збірка / RO: Montaj / BR: Montagem /  
EN: Assembly

1

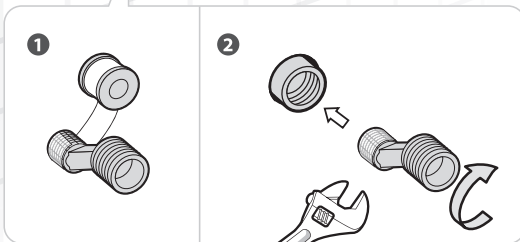
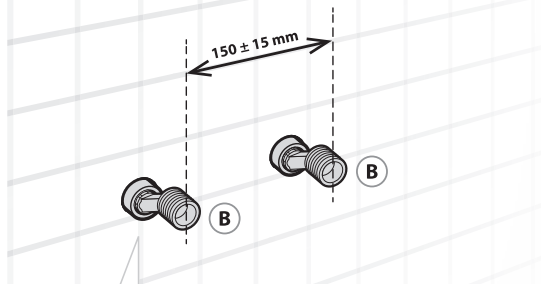

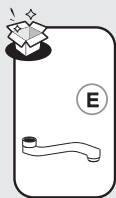

FR: Montage / ES: Montaje / PT: Montagem / IT: Montaggio / EL: Συναρμολόγηση /  
PL: Montaż / RU: Сборка / KZ: Монтаждау / UA: Збірка / RO: Montaj / BR: Montagem /  
EN: Assembly

1

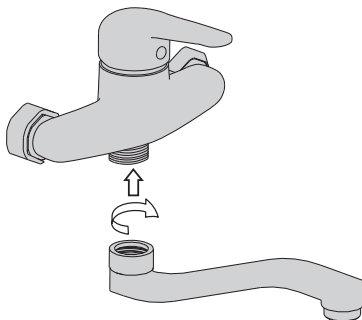



D



2

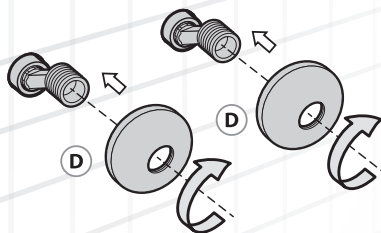



MIN.35 mm



C



3

1

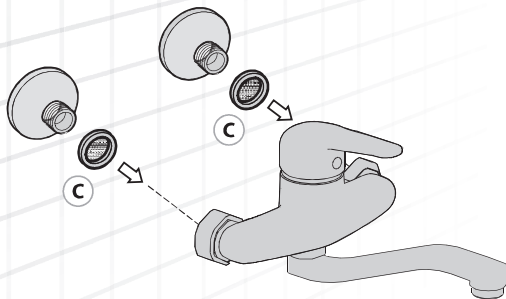

2

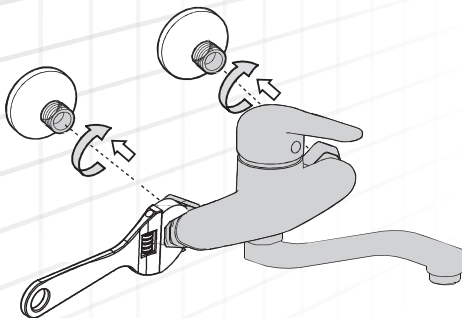

3

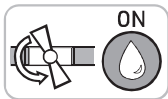





4

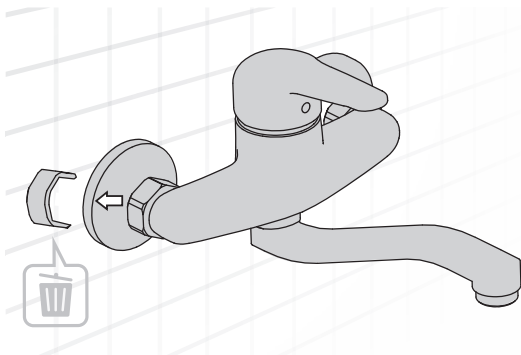



FR: Utilisation eau chaude-eau froide/ ES: Utilización agua caliente-agua fría/ PT: Utilização água quente-água fria/  
IT: Uso acqua calda-acqua fredda/ EL: Χρήση ζεστό-κρύου νερού/ PL: Użytkowanie zimnej wody-gorącej wody/  
RU: Использование горячей и холодной воды/ KZ: Суық және ыстық суды қолдану/  
UA: використання гарьчої - холодної води/ RO: Utilizare apă caldă-apă rece/ BR: Uso de água quente e fria/  
EN: Using hot and cold water

1

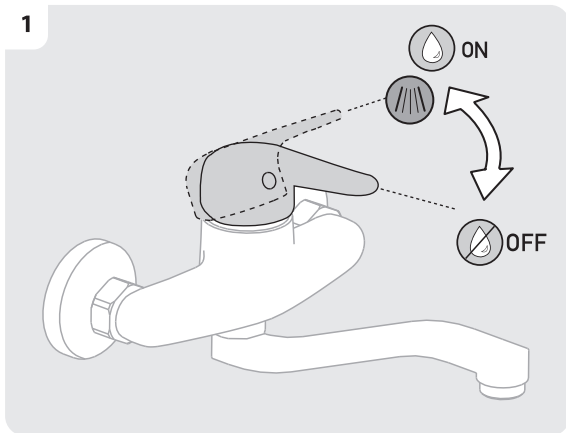
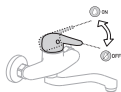

2

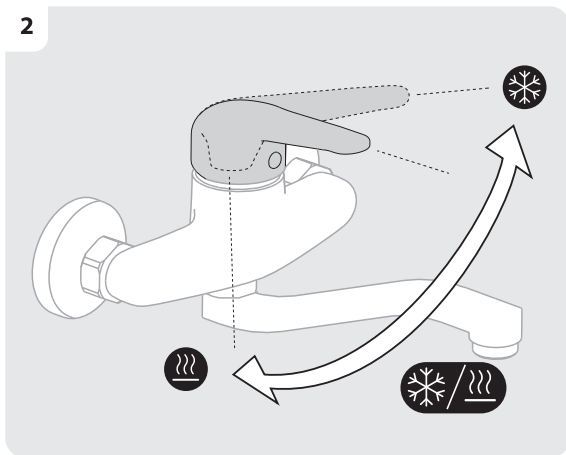

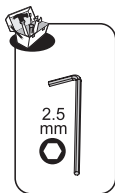

FR: Changement de cartouche/ ES: Cambio de cartucho/ IT: Cambio cartuccia/ PT: Mudança de cartucho/  
EL: Αλλαγή φιλτράγιου/ PL: Wymiana wkładu / RU: Смена картриджа/ KZ: Картриджді ауыстыру/  
UA: Заміна картриджа/ RO: Schimbare cartuş/ BR: Substituição de cartucho/ EN: Replacing the cartridge

1



OFF

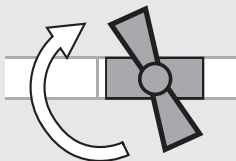

2

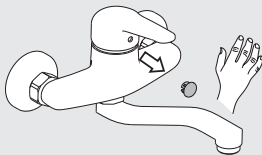

3



4

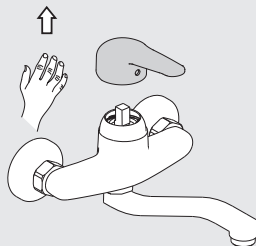

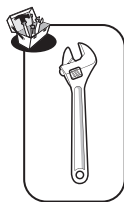

FR: Changement de cartouche/ ES: Cambio de cartucho/ IT: Cambio cartuccia/ PT: Mudança de cartucho/  
EL: Αλλαγή φουτιγγίου/ PL: Wymiana wkładu / RU: Смена картриджа/ KZ: Картриджді ауыстыру/  
UA: Заміна картриджа/ RO: Schimbare cartuş/ BR: Substituição de cartucho/ EN: Replacing the cartridge

5

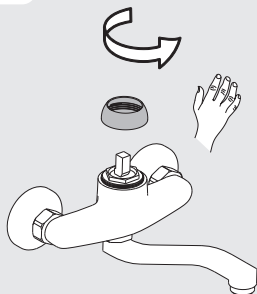

6

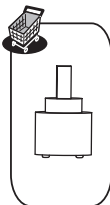
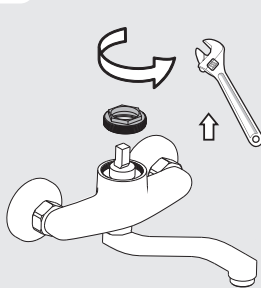

7



8

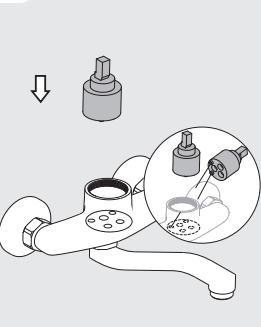

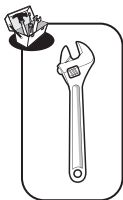

FR: Changement de cartouche/ ES: Cambio de cartucho/ IT: Cambio cartuccia/ PT: Mudança de cartucho/  
EL: Αλλαγή φιογγίου/ PL: Wymiana wkładu / RU: Смена картриджа/ KZ: Картриджді ауыстыру/  
UA: Заміна картриджа/ RO: Schimbare cartus/ BR: Substituição de cartucho/ EN: Replacing the cartridge

9

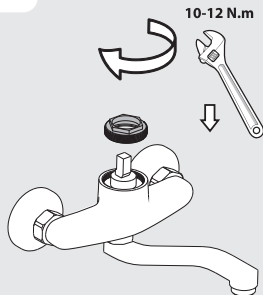

10

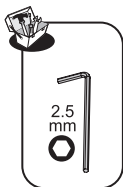
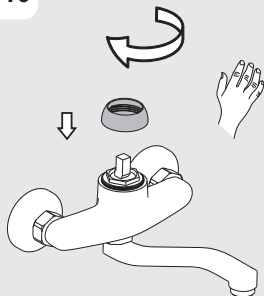

11

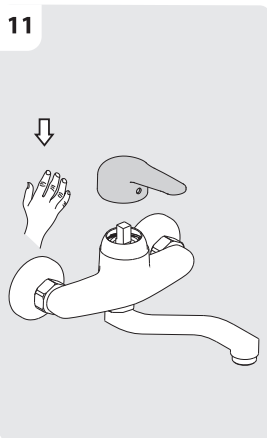

12

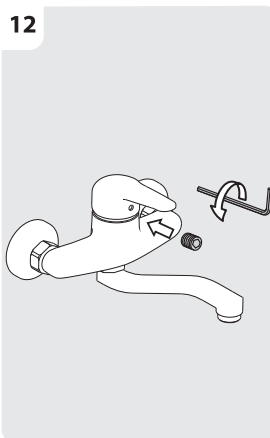



FR: Changement de cartouche/ ES: Cambio de cartucho/ IT: Cambio cartuccia/ PT: Mudança de cartucho/  
EL: Αλλαγή φρεσινγίου/ PL: Wymiana wkładu / RU: Смена картриджа/ KZ: Картриджді ауыстыру/  
UA: Заміна картриджа/ RO: Schimbare cartus/ BR: Substituição de cartucho/ EN: Replacing the cartridge

13

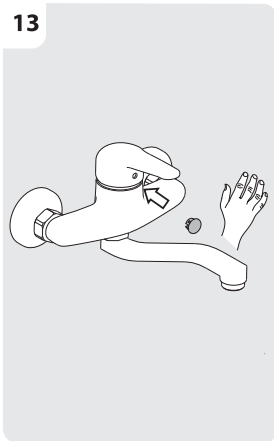

14

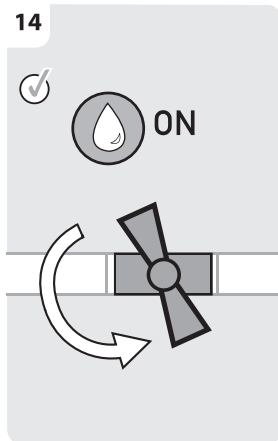

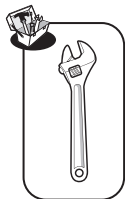
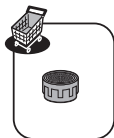

FR: Changement de mousseur/ ES: Cambio de aireador/ PT: Mudança de arejador/ IT: Cambio rompigetto/  
 EL: Αλλαγή αεράτορα / PL: Wymiana perlatora / RU: Смена аэратора/ KZ: Ауақаныңтығыршыты ауыстыру/  
 UA: Заміна аератора/ RO: Schimbare aerator/ BR: Substituição do aerador/ EN: Replacing the aerator

1

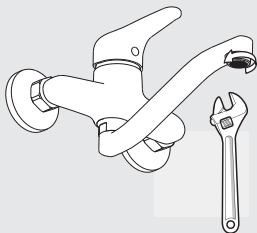

2

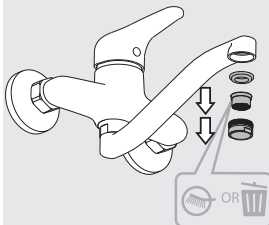

- |              |                |             |
|--------------|----------------|-------------|
| FR Nettoyage | EL Κωβάρισμος  | UA Очищення |
| ES Limpieza  | PL Czyszczenie | RO Curățare |
| PT Limpeza   | RU Чистка      | BR Limpeza  |
| IT Pulizia   | KZ тазау       | EN Cleaning |

3

- |             |          |             |            |
|-------------|----------|-------------|------------|
| FR Vinaigre | IT Aceto | RU Уксус    | RO Oțet    |
| ES Vinagre  | EL Ξύδι  | KZ Сірке су | BR Vinagre |
| PT Vinagre  | PL Ocet  | UA Оцет     | EN Vinegar |

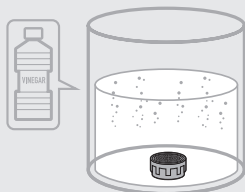

4

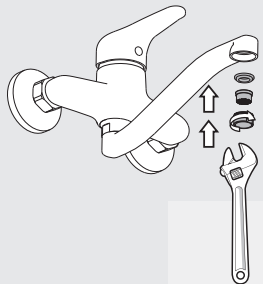



Eau claire / Agua limpia / Água limpa / Acqua pulita / Καθαρό νερό / Czysta woda / Чистая вода / Água limpa /  
Чиста вода / Apa curata / таза су / Clean water



Sans solvant / Sin disolvente / Sem solventes / Senza solventi / Χωρίς διαλυτικά / Bez rozpuszczalnika / Без растворителя /  
Sem solventes/ Без розчинника / Fara solvent / еріткішціс/ Solvent-free

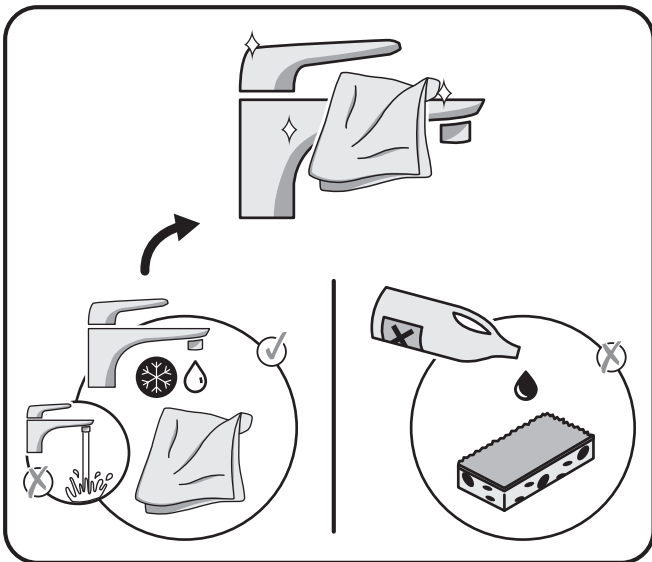



NO	DESCRIPTION	CODE NO	QTY	REMARK
1	Handle	25	1	
2	Beautify Cover	603087 CR	1	
3	Pressing Nut	604118 BC	1	
4	Cartridge	SN-40 S/D THEDRA	1	
5	Mixer Body	60255-01	1	
6	Spout	60255-002	1	
7	Aerator	40.2103.000	1	
8	Aerator Shell	301001 CR	1	
9	Fixing pack	T-23	2	

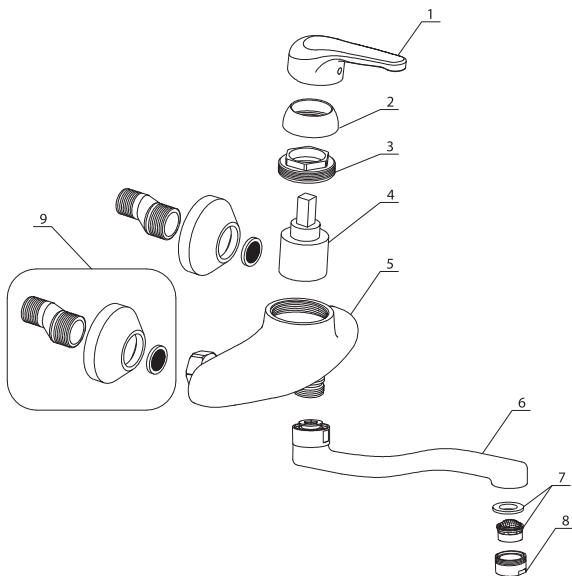

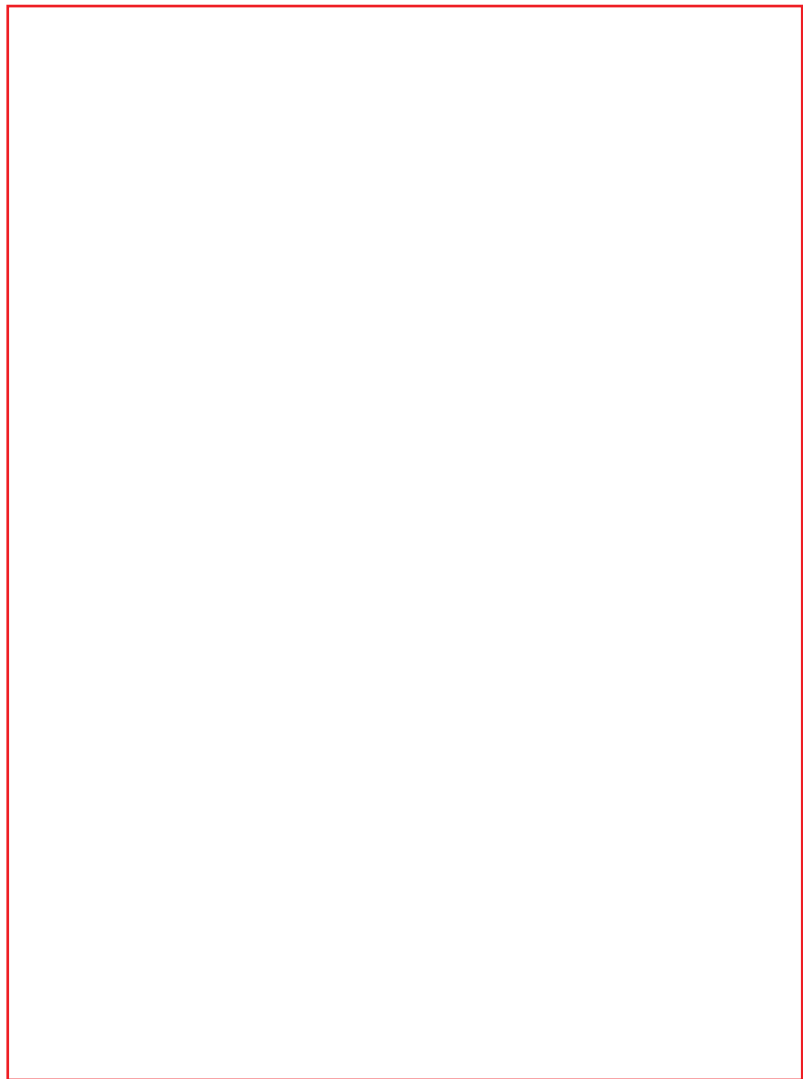

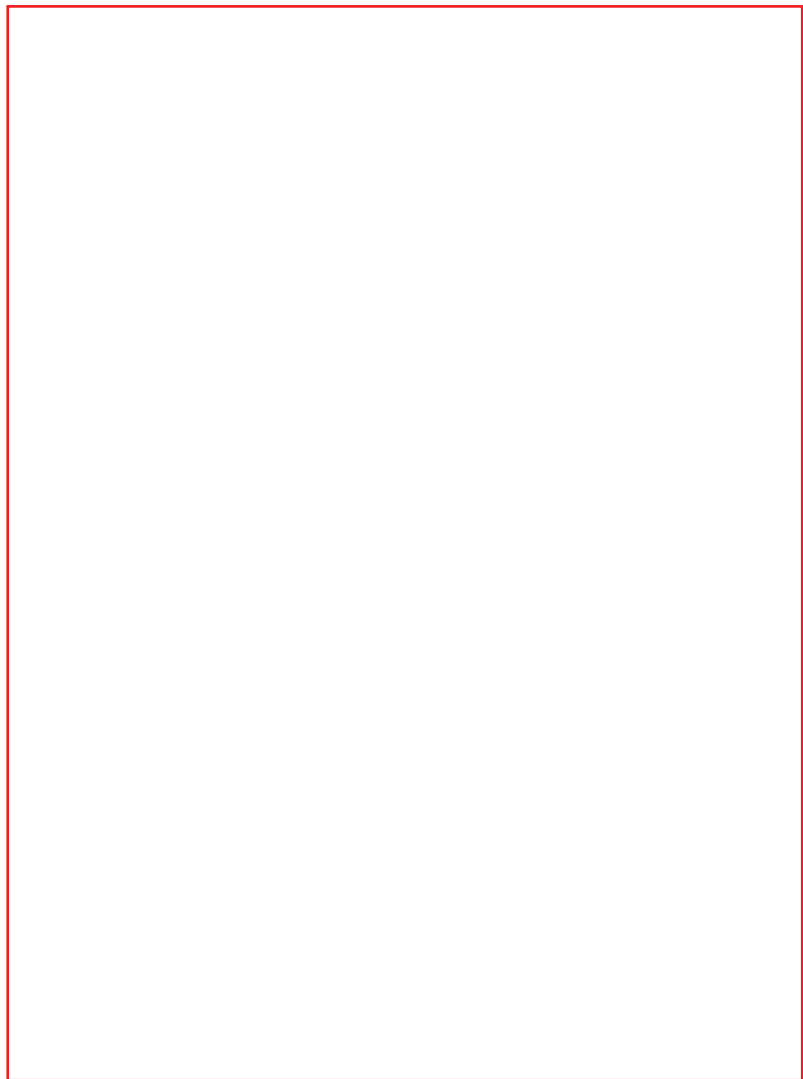



Certificado de conformidad sanitaria.  
Atestado de conformidade sanitária.  
certificato di conformità sanitaria.  
Βεβαίωση υγειονομικής συμμόρφωσης.  
Certyfikat zgodności sanitarnej.  
Декларація о соответствии санитарным нормам  
Санитарлық талаптарға сәйкестік декларациясы  
Декларація про відповідність санітарним нормам  
Atestat de conformitate sanitară  
Certificado de conformidade sanitária.  
Declaration of sanitary conformity.  
Attestation de conformité sanitaire



\* Garantie 10 ans / 10 años de garantía / Garantia de 10 anos / Garanzia 10 Anni / Εγγύηση 10 ετών / Gwarancja 10-letnia / Garantia 10 года / Kevillizik 10 жыл / Гарантія 10 років /  
Garantie 10 ani / 10 anos de garantia / 10-year guarantee

Made in P.R.C 2018

ADEO Services - 135 Rue Sadi Carnot - CS 00001  
59790 RONCHIN - France



ТОВ «Перуа Мерлен Україна»,  
вул. Полярна 17а, м. Київ 04201, Україна



**OK**

**TASK FORCE GREEN  
DOT / SORTING  
INSTRUCTION  
2021**