

delinia

Guarantee
10
years

DIEGO

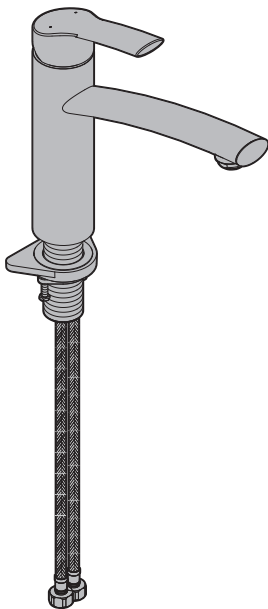

EAN CODE : 3276000592525

FR Manuel d'Instructions

ES Manual de Instrucciones

PT Manual de Instruções

IT Manuale di Istruzioni

EL Εγχειρίδιο Οδηγών

PL Instrukcja Obsługi

RU Руководство по
эксплуатации

KZ Пайдаланушы Нұсқаулығы

UA Інструкція з Експлуатації

RO Manual de Instrucțiuni

BR Manual de Instruções

EN Instructions Manual

2020/05/01

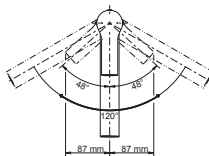
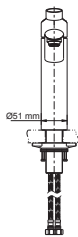
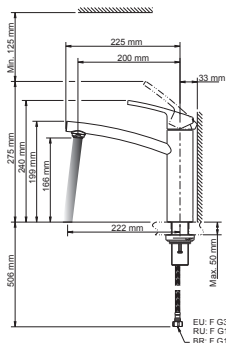

B

A

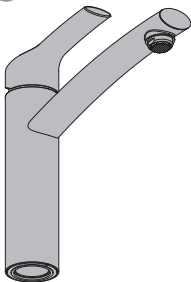

C



D



E



F



G



BR





FR: Préparation / ES: Preparación / PT: Preparação / IT: Preparazione / EL: Προετοιμασία /
PL: Przygotowanie / RU: Подготовка / KZ: Дайындау / UA: Підготування / RO: Pregătire / BR: Preparação /
EN: Preparation

 4



FR: Montage / ES: Montaje / PT: Montagem / IT: Montaggio / EL: Συναρμολόγηση /
PL: Montaż / RU: Сборка / KZ: Монтаждау / UA: Збірка / RO: Montaj / BR: Montagem /
EN: Assembly

 5 → 7



FR: Utilisation eau chaude-eau froide/ ES: Utilización agua caliente-agua fría/ PT: Utilização água quente-água fria/
IT: Uso acqua calda-acqua fredda/ EL: Χρήση ζεστή-κρύου νερού/ PL: Użytkowanie zimnej wody-gorącej wody/
RU: использование горячей и холодной воды/ KZ: Суық және ыстық суды қолдану/ UA: використання гарячої
холодної води/ RO: Utilizare apă caldă-apă rece/ BR: Uso de água quente e fria/ EN: Using hot and cold water

 8

FR: Changement de cartouche/ ES: Cambio de cartucho/ PT: Mudança de cartucho/ IT: Cambio cartuccia/
EL: Αλλαγή φωτογείου/ PL: Wymiana wkładu/ RU: Смена картриджа/ KZ: Картриджді ауыстыру/
UA: Заміна картриджа/ RO: Schimbare cartus/ BR: Substituição de cartucho/ EN: Replacing the cartridge

 9 → 12

FR: Changement de mousseur/ ES: Cambio de aireador/ PT: Mudança de arejador/ IT: Cambio rompigetto/
EL: Αλλαγή αεράτορα/ PL: Wymiana perlatora/ RU: Смена аэратора/ KZ: Ауақанықтырғышты ауыстыру/
UA: Заміна аератора/ RO: Schimbare aerator/ BR: Substituição do aerador/ EN: Replacing the aerator

 13

FR: Changement de flexibles/ ES: Cambio de flexibles/ PT: Mudança de flexíveis/ IT: Cambio flessibili/
EL: Αλλαγή λάστιχων/ PL: Wymiana wężyków instalacyjnych / RU: Смена гибкого шланга для смесителя/
KZ: Қоспауышқа арналған иілгіш шлангты ауыстыру/ UA: Заміна гнучкого шланга для змішувача/
RO: Schimbare furtune flexibile/ BR: Substituição das mangueiras/ EN: Replacing the hoses

 14 → 15



FR: Préparation / ES: Preparación / PT: Preparação / IT: Preparazione / EL: Προετοιμασία /
PL: Przygotowanie / RU: Подготовка / KZ: Дайындау / UA: Підготовка / RO: Pregătire /
BR: Preparação / EN: Preparation

1

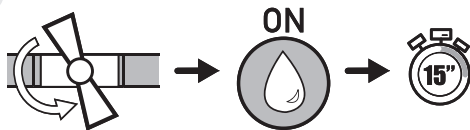

2

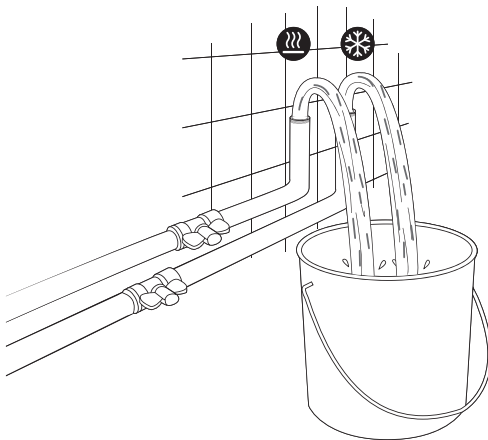

3

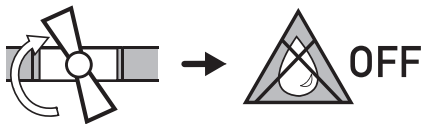

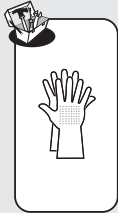
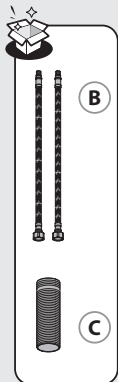

FR: Montage / ES: Montaje / PT: Montagem / IT: Montaggio / EL: Συνορμολόγηση /
 PL: Montaż / RU: Сборка / KZ: Монтаж / UA: Збірка / RO: Montaj / BR: Montagem /
 EN: Assembly

1

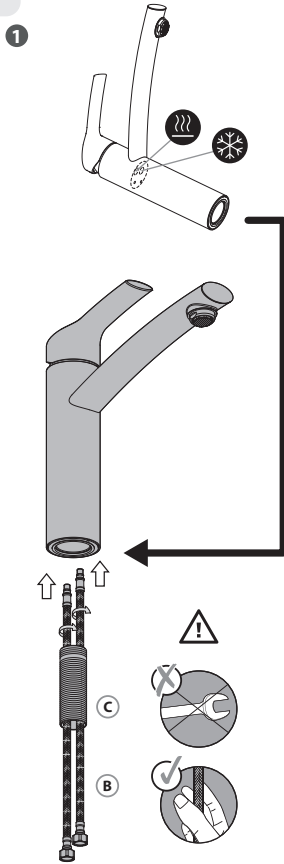

2

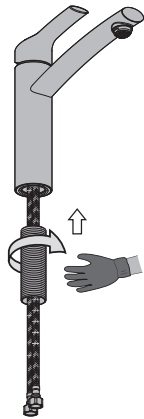

3

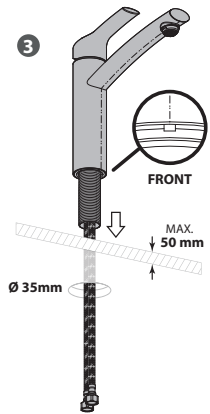



A

2

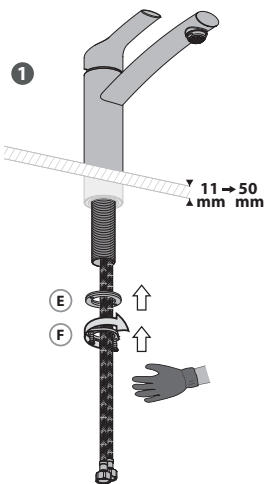
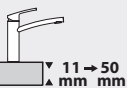

2

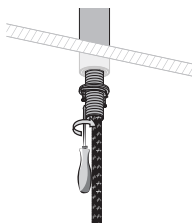

B

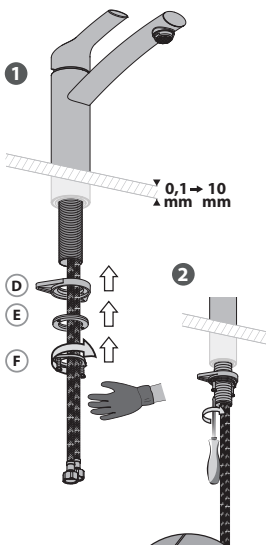

2

D
E
F

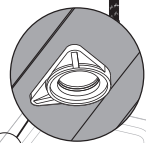

D





3

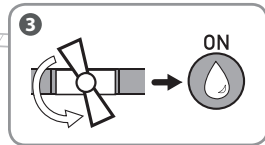
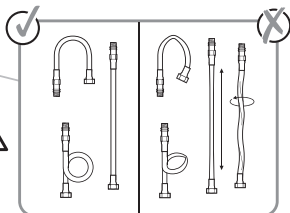
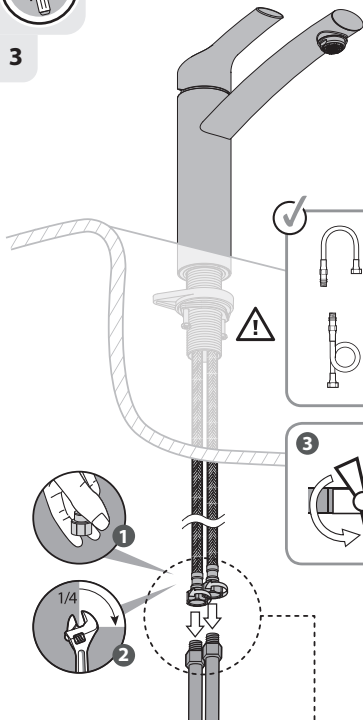

BR

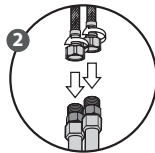
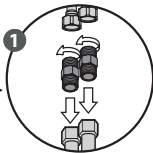



FR: Utilisation eau chaude-eau froide/ ES: Utilización agua caliente-agua fría/ PT: Utilização água quente-água fria/
IT: Uso acqua calda-acqua fredda/ EL: Χρήση ζεστού-κρύου νερού/ PL: Użytkowanie zimnej wody-gorącej wody/
RU: Використання гарячої води/ KZ: Суық және ыстық суды қолдану/ UA: води - холодної води/
RO: Utilizare apă caldă-apă rece/ BR: Uso de água quente e fria/ EN: Using hot and cold water

1

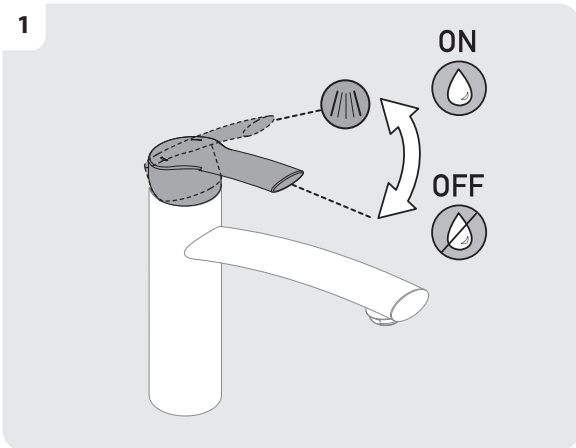
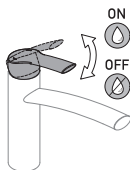

2



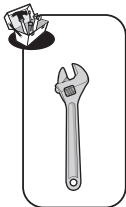

FR: Utilisation eau chaude-eau froide/ ES: Utilización agua caliente-agua fría/ PT: Utilização água quente-água fria/
IT: Uso acqua calda-acqua fredda/ EL: Χρήση (ζεστό-κρύο νερό)/ PL: Użytkowanie zimnej wody-gorącej wody/
RU: использование горячей и холодной воды/ KZ: Суық және ыстық суды қолдану/ UA: використання гарячої-холодної води/ RO: Utilizare apă caldă-apă rece/ BR: Uso de água quente e fria/ EN: Using hot and cold water

1

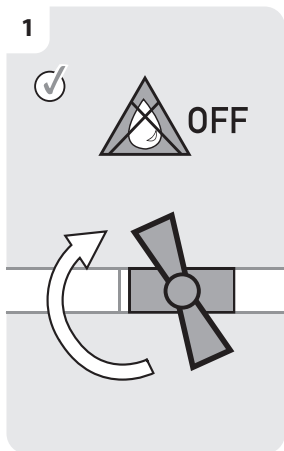

2

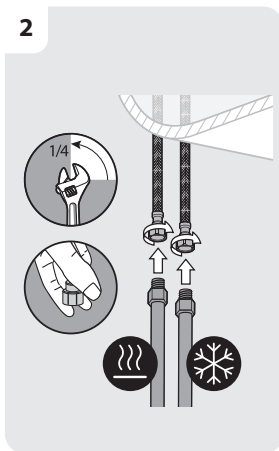

3

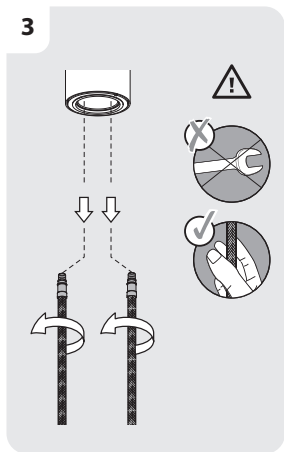

4

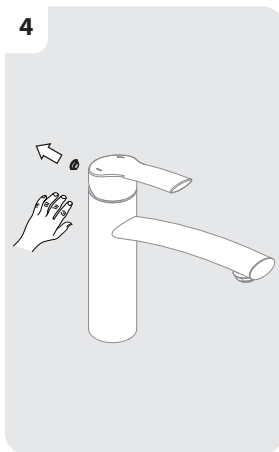

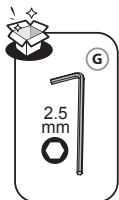

FR: Changement de cartouche/ ES: Cambio de cartucho/ PT: Mudança de cartucho/ IT: Cambio cartuccia/
 EL: Αλλαγή φουσιγγίου/ PL: Wymiana wkładu/ RU: Смена картриджа/ KZ: Картриджкі ауыстыру/
 UA: Заміна картриджа/ RO: Schimbare cartus/ BR: Substituição de cartucho/ EN: Replacing the cartridge

5

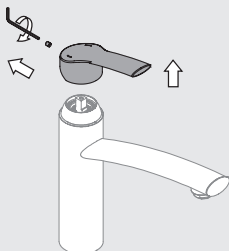

6

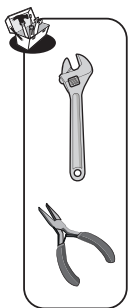
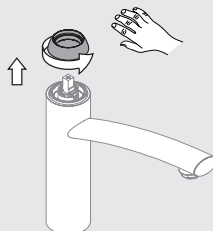

7

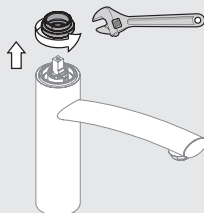

8



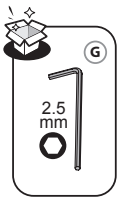
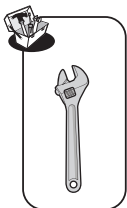

FR: Changement de cartouche/ ES: Cambio de cartucho/ PT: Mudança de cartucho/ IT: Cambio cartuccia/
EL: Αλλαγή φουσιγγίου/ PL: Wymiana wkładu/ RU: Смена картриджа/ KZ: Картриджкі ауыстыру/
UA: Заміна картриджа/ RO: Schimbare cartus/ BR: Substituição de cartucho/ EN: Replacing the cartridge

9

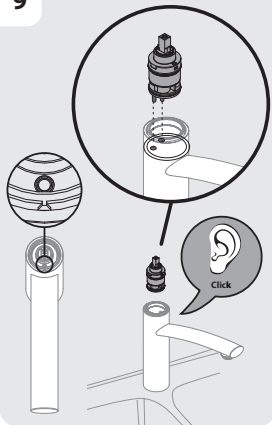

10

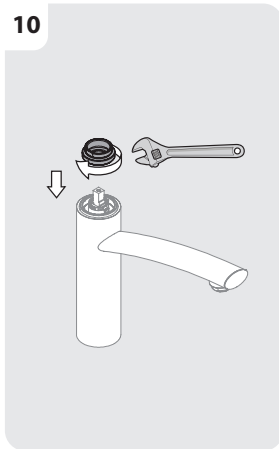

11



12

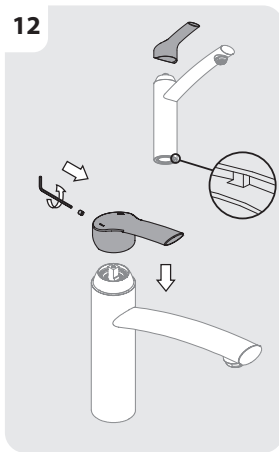



FR: Changement de cartouche/ ES: Cambio de cartucho/ PT: Mudança de cartucho/ IT: Cambio cartuccia/
EL: Αλλαγή φουσιγγίου/ PL: Wymiana wkładu/ RU: Смена картриджа/ KZ: Картриджкі ауыстыру/
UA: Заміна картриджа/ RO: Schimbare cartus/ BR: Substituição de cartucho/ EN: Replacing the cartridge

13



14

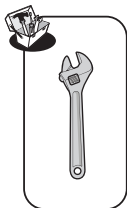
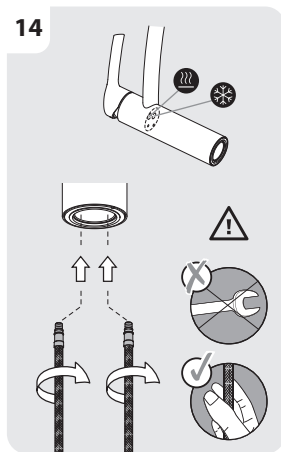

15

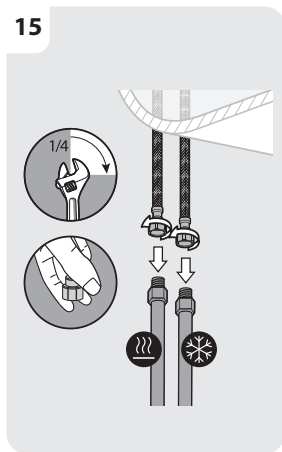

16

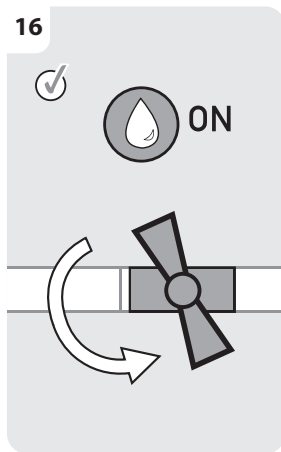

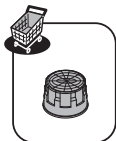
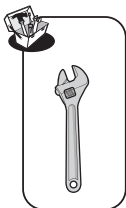

FR: Changement de mousseur/ ES: Cambio de aireador/ PT: Mudança de arejador/ IT: Cambio rompigetto/
 EL: Αλλαγή αεράτορα/ PL: Wymiana perlatora/ RU: Смена аэратора/ KZ: Ауақанықтығыршыты ауыстыру/
 UA: Заміна аератора/ RO: Schimbare aerator/ BR: Substituição do aerador/ EN: Replacing the aerator

1

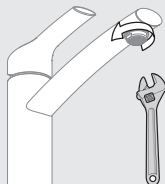

2



- | | | |
|--------------|-----------------|-------------|
| FR Nettoyage | ES Καθαρισμός | UA Очищення |
| ES Limpieza | PL Czyszczzenie | RO Curățare |
| PL Limpeza | RU Чистка | BR Limpeza |
| BR Limpeza | KZ тазарту | EN Cleaning |

3

- | | | | |
|-------------|----------|-------------|------------|
| FR Vinaigre | PL Aceto | RU Уксус | RO Oțet |
| ES Vinagre | EL Σόδα | KZ Сірке су | BR Vinagre |
| PL Vinagre | UA Ocet | UA Ocet | EN Vinegar |

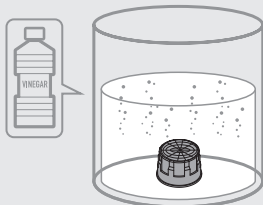

4

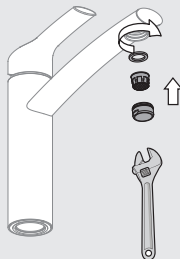

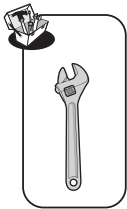

FR: Changement de flexibles/ ES: Cambio de flexibles/ PT: Mudança de flexíveis/ IT: Cambio flessibili/
EL: Αλλαγή λάστιχων/ PL: Wymiana wężyków instalacyjnych/ RU: Замена гибкого шланга для смесителя/
KZ: Қоспауысықа арналған иілгіш шлангты ауыстыру/ UA: Заміна гнучкого шланга для змішувача/
RO: Schimbare furtune flexibile/ BR: Substituição das mangueiras/ EN: Replacing the hoses

1

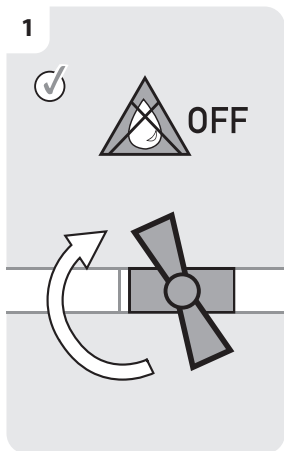

2

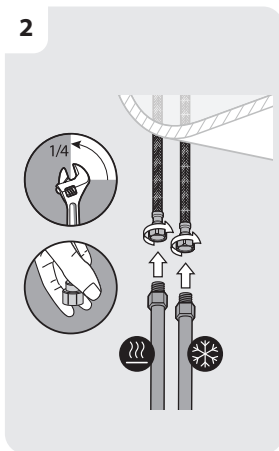

3



4

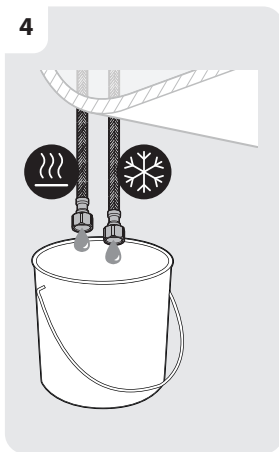

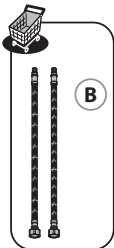

FR: Changement de flexibles/ ES: Cambio de flexibles/ PT: Mudança de flexíveis/ IT: Cambio flessibili/
 EL: Αλλαγή λάστιχων/ PL: Wymiana wężyków instalacyjnych/ RU: Замена гибкого шланга для смешивателя/
 KZ: Қоспауысуыққа арналған иілгіш шлангты ауыстыру/ UA: Заміна гнучкого шланга для змішувача/
 RO: Schimbare furtune flexibile/ BR: Substituição das mangueiras/ EN: Replacing the hoses

5

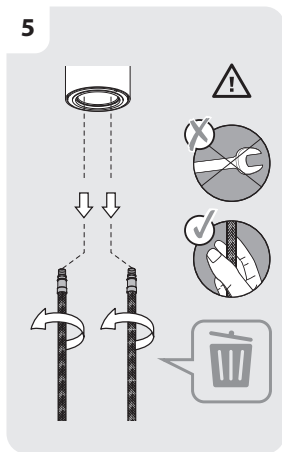

6

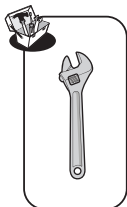
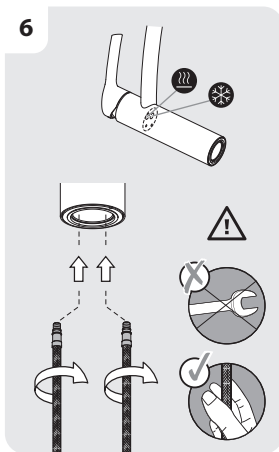

7

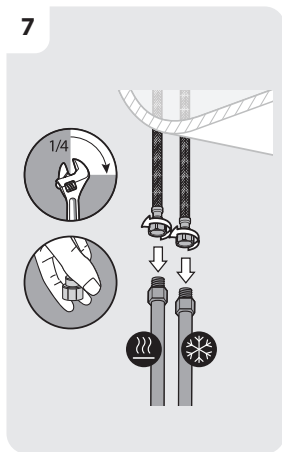

8

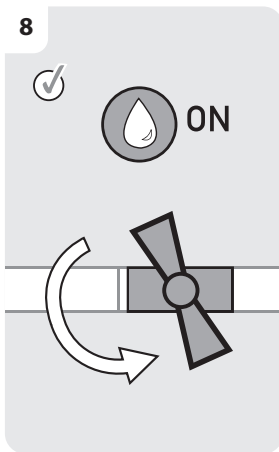



Eau claire / Agua limpia / Água limpa / Acqua pulita / Каваро веро / Czysta woda / Чистая вода / Sem solventes /
Чиста вода / Арă curată / Água limpa / Clean water



Sans solvant / Sin disolvente / Sem solventes / Senza solventi / Хуриç диалутикă / Bez rozpuszczalnika / Без растворителя /
еріткішçіç / Без розчинника / Fără solvent / таза су / Solvent-free

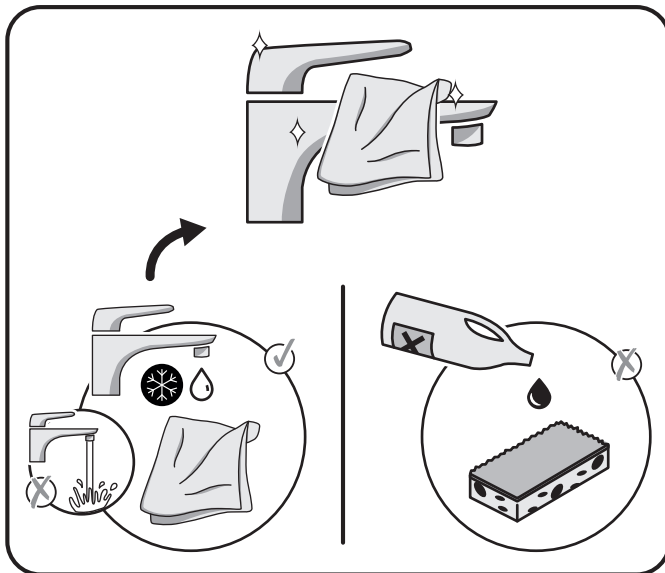

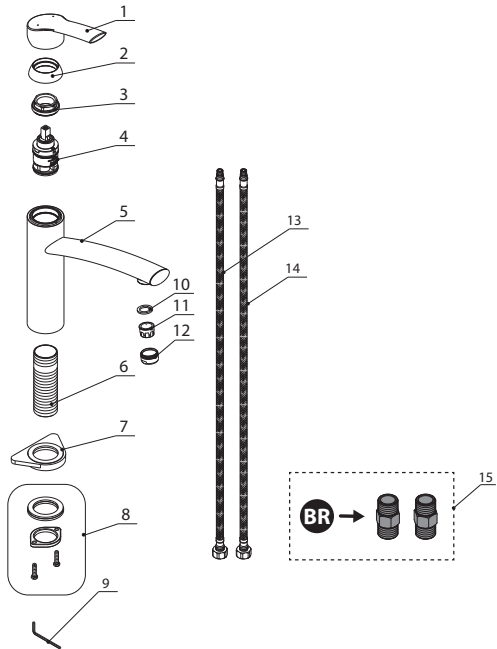

NO.	Description	Code No.	QTY	Remark
1	Handle	A662A86-51	1	
2	Beautifying cover	A508013-T	1	
3	Compressing nut	A104353-P	1	
4	Cartridge	CC-35	1	
5	Body spout assembly	551136E-51-AX	1	
6	Easy fix shank	A228164	1	
7	Plastic triangle	A663B13	1	
8	Fixing kit	A663B14	1	
9	L-wrench	A031000	1	
10	Seal	A010003N	1	
11	Aerator	40.0003.000	1	
12	Aerator housing	A305641E	1	
13	Inlet hose(H)	TAQ-PEX-DN6-ACB H3/8-M8X1 L12-650-R-QB	1	
14	Inlet hose(C)	TAQ-PEX-DN6-ACB H3/8-M8X1 L12-650-QB	1	
15	Connectors	A668322	1	







Certificado de conformidad sanitaria.
Atestado de conformidade sanitária.
certificato di conformità sanitaria.
Βεβαίωση υγιεινότητας συμμόρφωσης.
Сертификат zgodności sanitarnej.
Декларация о соответствии санитарным нормам
Санитарлық талаптарға сәйкестік декларациясы
Декларація про відповідність санітарним нормам
Atestat de conformitate sanitară
Certificado de conformidade sanitária.
Declaration of sanitary conformity.
Attestation de conformité sanitaire

* Garantie 10 ans / 10 años de garantía / Garantia de 10 anos / Garanzia 10 Anni / Εγγύηση 10 ετών / Gwarancja 10-letnia / Гарантія 10 років / Келіңдік 10 жыл / Гарантія 10 років / Garantie 10 ani / 10 años de garantía / 10-year guarantee

Made in P.R.C. 2018

ADEO Services - 135 Rue Sadi Carnot - CS 00001
59790 RONCHIN - France

UA ТОВ «Ітера Меркен Україна»,
вул. Полірна 17а, м. Київ 04201, Україна

