

EAN CODE : 3276000592525

FR Manuel d'Instructions

ES Manual de Instrucciones

PT Manual de Instruções

IT Manuale di Istruzioni

EL Εγχειρίδιο Οδηγίων

PL Instrukcja Obsługi

RU Руководство по
эксплуатации

KZ Пайдаланушы Нұсқаулығы

UA Інструкція з Експлуатації

RO Manual de Instrucțiuni

BR Manual de Instruções

EN Instructions Manual

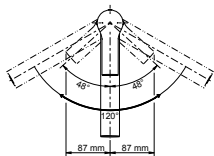
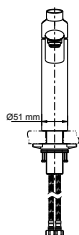
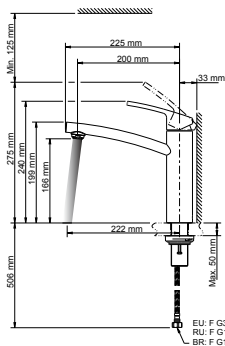

B

A

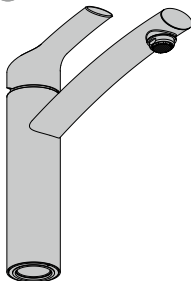

C



D



E



F



G

BR





FR: Préparation / ES: Preparación / PT: Preparação / IT: Preparazione / EL: Προετοιμασία /
PL: Przygotowanie / RU: Подготовка / KZ: Дайындау / UA: Підготовка / RO: Pregătire / BR: Preparação /
EN: Preparation



FR: Montage / ES: Montaje / PT: Montagem / IT: Montaggio / EL: Συναρμολόγηση /
PL: Montaż / RU: Сборка / KZ: Монтаждау / UA: Збірка / RO: Montaj / BR: Montagem /
EN: Assembly

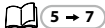

FR: Utilisation eau chaude-eau froide/ ES: Utilización agua caliente-agua fría/ PT: Utilização água quente-água fria/
IT: Uso acqua calda-acqua fredda/ EL: Χρήση ζεστού-κρύου νερού/ PL: Użytkowanie zimnej wody-gorącej wody/
RU: использование горячей и холодной воды/ KZ: Суық және ыстық суды қолдану/ UA: використання гарячої-
холодної води/ RO: Utilizare apă caldă-apă rece/ BR: Uso de água quente e fria/ EN: Using hot and cold water



FR: Changement de cartouche/ ES: Cambio de cartucho/ PT: Mudança de cartucho/ IT: Cambio cartuccia/
EL: Αλλαγή φυσιγγίου/ PL: Wymiana wkładu/ RU: Смена картриджа/ KZ: Картриджі ауыстыру/
UA: Заміна картриджа/ RO: Schimbare cartuş/ BR: Substituição de cartucho/ EN: Replacing the cartridge

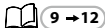

FR: Changement de mousseur/ ES: Cambio de aireador/ PT: Mudança de arejador/ IT: Cambio rompigoetto/
EL: Αλλαγή αεράτορα/ PL: Wymiana perlatora/ RU: Смена аэратора/ KZ: Ауақанықтырғышты ауыстыру/
UA: Заміна аератора/ RO: Schimbare aerator/ BR: Substituição do aerador/ EN: Replacing the aerator



FR: Changement de flexibles/ ES: Cambio de flexibles/ PT: Mudança de flexíveis/ IT: Cambio flessibili/
EL: Αλλαγή λάστιχων/ PL: Wymiana wężyków instalacyjnych / RU: Смена гибкого шланга для смесителя/
KZ: Қоспауышқа арналған иілгіш шлангты ауыстыру/ UA: Заміна гнучкого шланга для змішувача/
RO: Schimbare furtune flexibile/ BR: Substituição das mangueiras/ EN: Replacing the hoses





FR: Préparation / ES: Preparación / PT: Preparação / IT: Preparazione / EL: Προετοιμασία /
PL: Przygotowanie / RU: Подготовка / KZ: Дайындау / UA: Підготовка / RO: Pregătire /
BR: Preparação / EN: Preparation

1

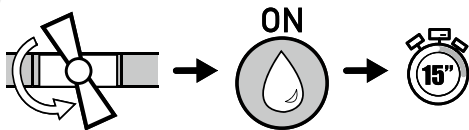

2

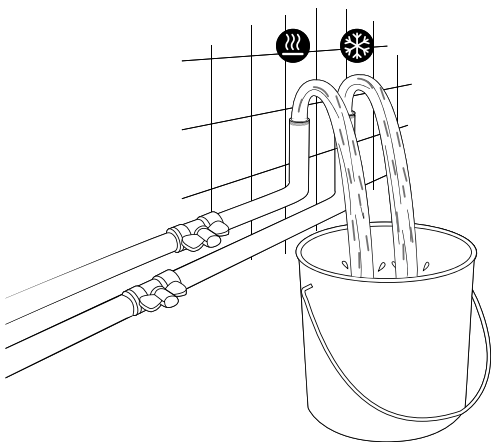

3

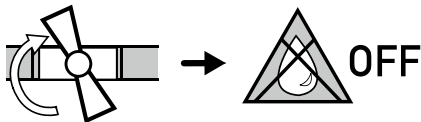

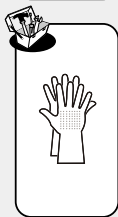
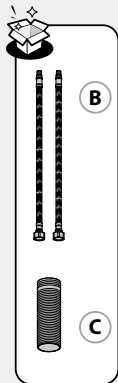

FR: Montage / ES: Montaje / PT: Montagem / IT: Montaggio / EL: Συναρμολόγηση /
 PL: Montaż / RU: Сборка / KZ: Монтаж / UA: Збірка / RO: Montaj / BR: Montagem /
 EN: Assembly

1

1

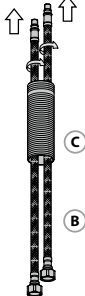
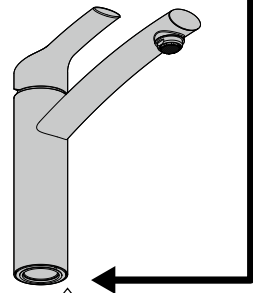
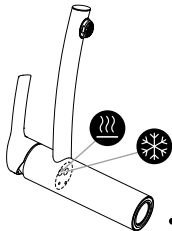

2

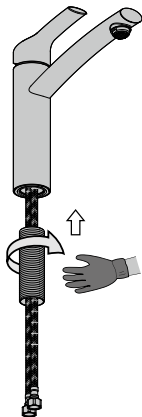

3

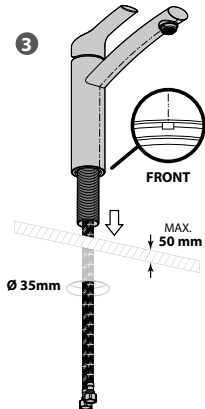

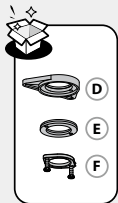

2



A

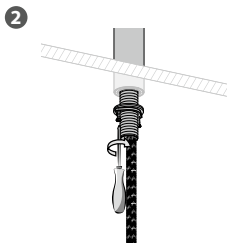
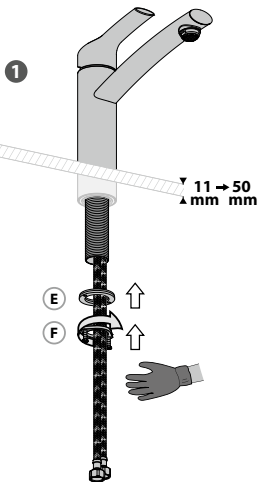
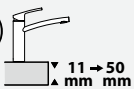

B

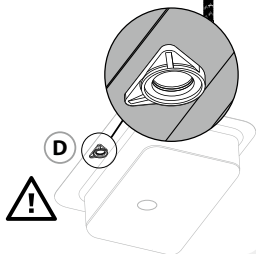
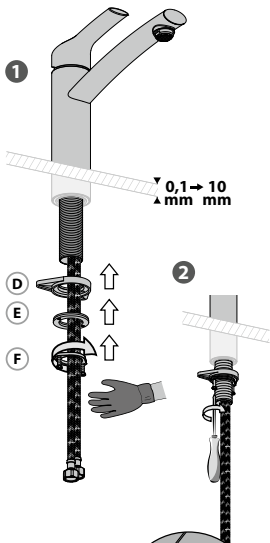

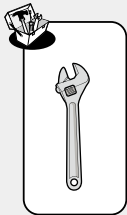

3

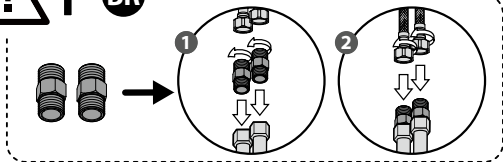
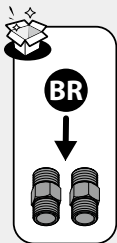
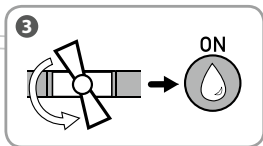
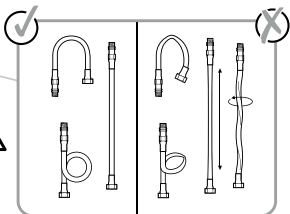
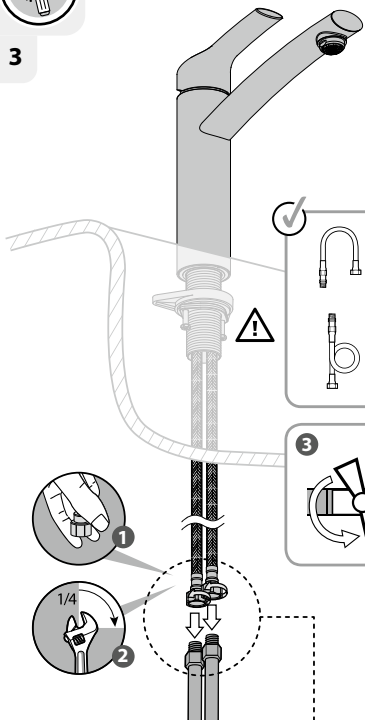



FR: Utilisation eau chaude-eau froide/ **ES:** Utilización agua caliente-agua fría/ **PT:** Utilização água quente-água fria/
IT: Uso acqua calda-acqua fredda/ **EL:** Χρήση ζεστού-κρύου νερού/ **PL:** Użytkowanie zimnej wody-gorącej wody/
RU: Використання гарячої води/ **KZ:** Суық және ыстық суды қолдану/ **UA:** води - холодної води/
RO: Utilizare apă caldă-apă rece/ **BR:** Uso de água quente e fria/ **EN:** Using hot and cold water

1

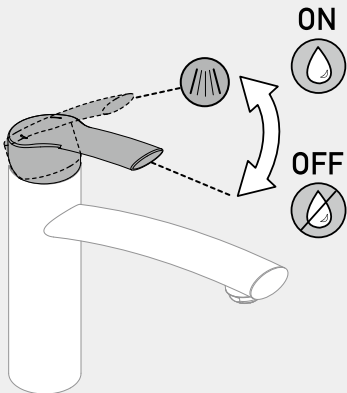
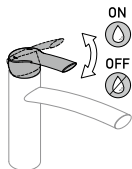

2

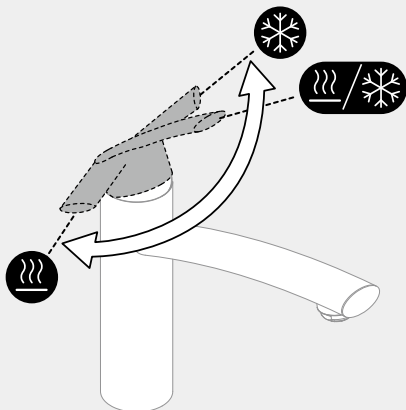

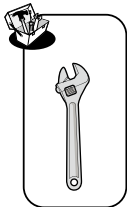

FR: Utilisation eau chaude-eau froide/ ES: Utilización agua caliente-agua fría/ PT: Utilização água quente-água fria/
IT: Uso acqua calda-acqua fredda/ EL: Χρήση ζεστού-κρύου νερού/ PL: Użytkowanie zimnej wody-gorącej wody/
RU: использование горячей и холодной воды/ KZ: Суық және ыстық суды қолдану/ UA: використання гарячої-холодної води/ RO: Utilizare apă caldă-apă rece/ BR: Uso de água quente e fria/ EN: Using hot and cold water

1



OFF

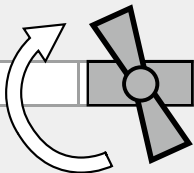

2

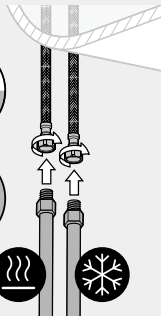

3

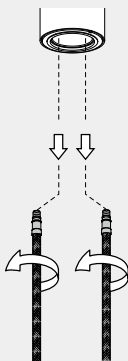

4

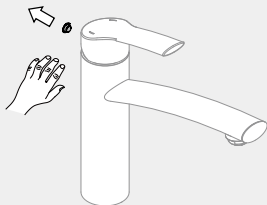

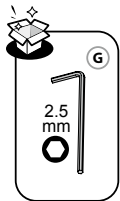

FR: Changement de cartouche/ ES: Cambio de cartucho/ PT: Mudança de cartucho/ IT: Cambio cartuccia/
 EL: Αλλαγή φουσιγγίου/ PL: Wymiana wkładu/ RU: Смена картриджа/ KZ: Картриджи ауыстыру/
 UA: Заміна картриджа/ RO: Schimbare cartus/ BR: Substituição de cartucho/ EN: Replacing the cartridge

5

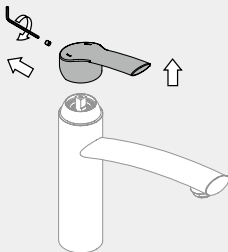

6



7

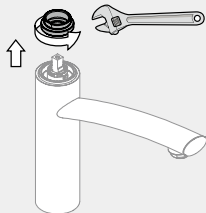

8

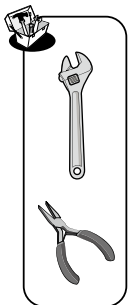

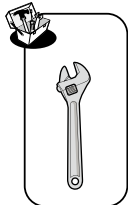

FR: Changement de cartouche/ ES: Cambio de cartucho/ PT: Mudança de cartucho/ IT: Cambio cartuccia/
EL: Αλλαγή φουσιγγίου/ PL: Wymiana wkładu/ RU: Смена картриджа/ KZ: Картриджи ауыстыру/
UA: Заміна картриджа/ RO: Schimbare cartus/ BR: Substituição de cartucho/ EN: Replacing the cartridge

9

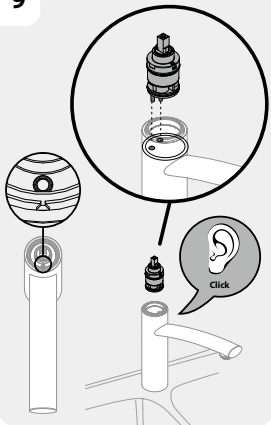

10

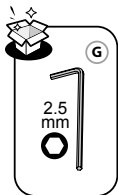

11



12

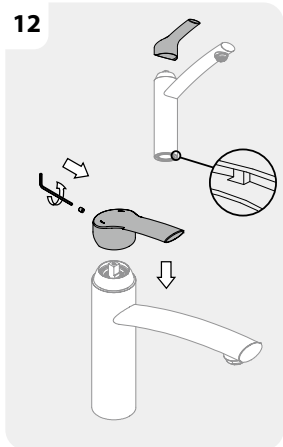



FR: Changement de cartouche/ ES: Cambio de cartucho/ PT: Mudança de cartucho/ IT: Cambio cartuccia/
EL: Αλλαγή φουσιγγίου/ PL: Wymiana wkładu/ RU: Смена картриджа/ KZ: Картриджи ауыстыру/
UA: Заміна картриджа/ RO: Schimbare cartus/ BR: Substituição de cartucho/ EN: Replacing the cartridge

13

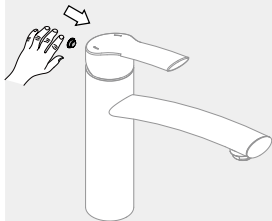

14

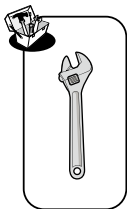
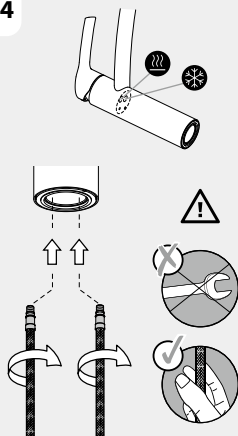

15

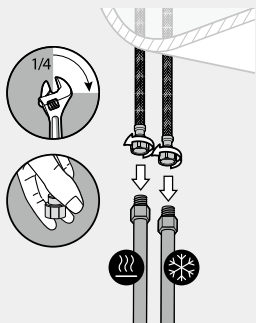

16

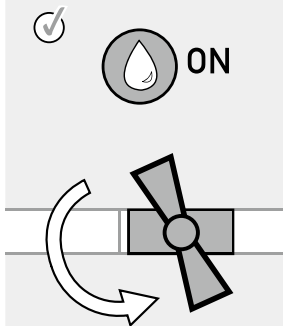

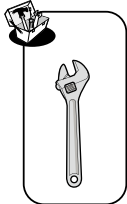

FR: Changement de mousseur/ ES: Cambio de aireador/ PT: Mudança de arejador/ IT: Cambio rompigoetto/
 EL: Αλλαγή αεράτορα/ PL: Wymiana perlatora/ RU: Смена аэратора/ KZ: Ауақанықтырғышты ауыстыру/
 UA: Заміна аератора/ RO: Schimbare aerator/ BR: Substituição do aerador/ EN: Replacing the aerator

1



2

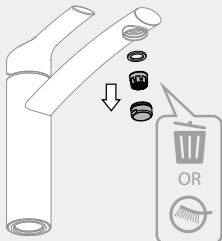

FR Nettoyage EL Καθαρισμός UA Очищення
 ES Limpieza PL Czyszczenie RO Curatare
 PT Limpeza RU Чистка BR Limpeza
 IT Pulizia KZ тазарту EN Cleaning

3

FR Vinaigre IT Aceto RU Уксус RO Oțet
 ES Vinagre EL Ξίδι KZ Сірке су BR Vinagre
 PT Vinagre PL Ocet UA Оцет EN Vinegar

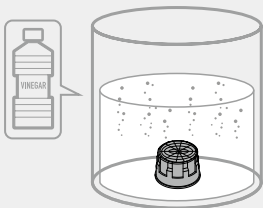

4

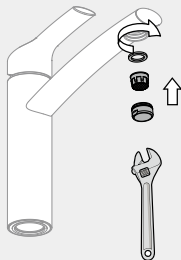

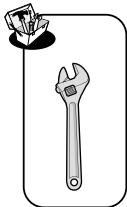

FR: Changement de flexibles/ ES: Cambio de flexibles/ PT: Mudança de flexíveis/ IT: Cambio flessibili/
EL: Αλλαγή λάστιχων/ PL: Wymiana wężyków instalacyjnych / RU: Смена гибкого шланга для смесителя/
KZ: Қоспауышқа арналған иілгіш шлангты ауыстыру/ UA: Заміна гнучкого шланга для змішувача/
RO: Schimbare furtune flexibile/ BR: Substituição das mangueiras/ EN: Replacing the hoses

1

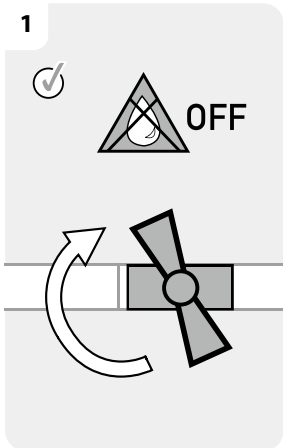

2

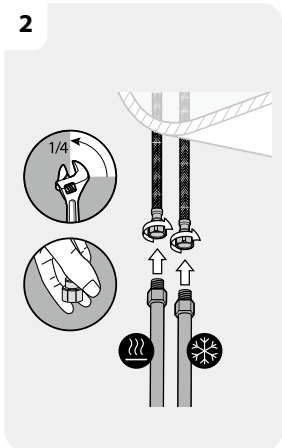

3



4

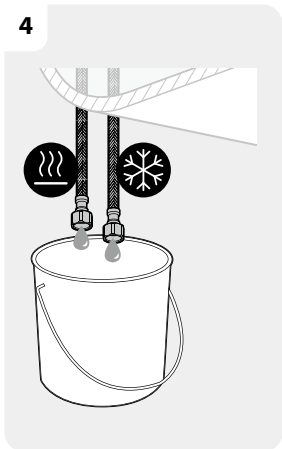

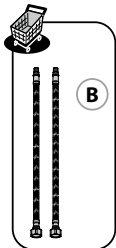

FR: Changement de flexibles/ ES: Cambio de flexibles/ PT: Mudança de flexíveis/ IT: Cambio flessibili/
 EL: Αλλαγή λάστιχων/ PL: Wymiana wężyków instalacyjnych/ RU: Смена гибкого шланга для смесителя/
 KZ: Қоспауышқа арналған иілгіш шлангты ауыстыру/ UA: Заміна гнучкого шланга для змішувача/
 RO: Schimbare furture flexibile/ BR: Substituição das mangueiras/ EN: Replacing the hoses

5

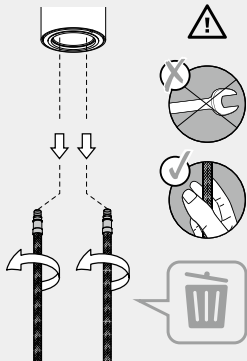

6

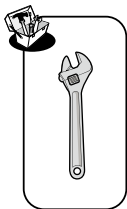
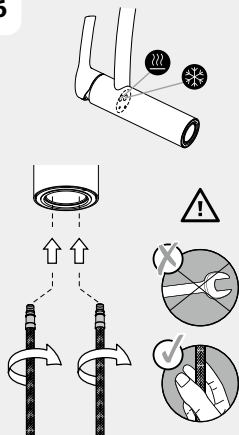

7

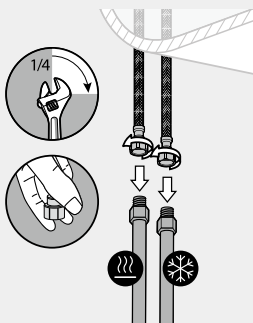

8

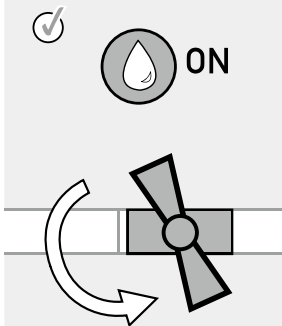



Eau claire / Agua limpia / Água limpa / Acqua pulita / Καθαρό νερό / Czysta woda / Чистая вода / Sem solventes /
Чиста вода / Apă curată / Agua limpa / Clean water



Sans solvant / Sin disolvente / Sem solventes / Senza solventi / Χωρίς διαλυτικά / Bez rozpuszczalnika / Без растворителя /
еріткішсіз / Без розчинника / Fără solvent / таза су / Solvent-free

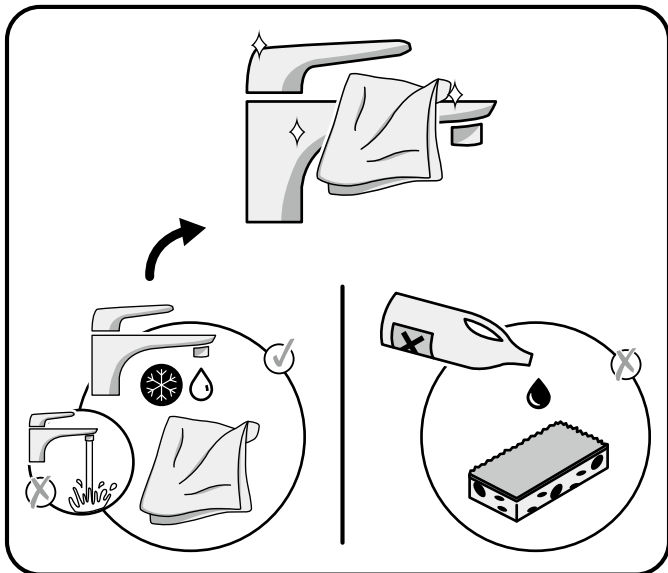

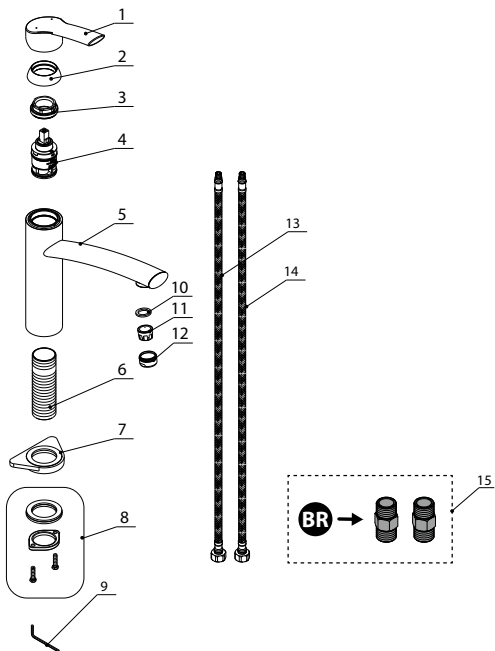

NO.	Description	Code No.	QTY	Remark
1	Handle	A662A86-51	1	
2	Beautifying cover	A508013-T	1	
3	Compressing nut	A104353-P	1	
4	Cartridge	CC-35	1	
5	Body spout assembly	551136E-51-AX	1	
6	Easy fix shank	A228164	1	
7	Plastic triangle	A663B13	1	
8	Fixing kit	A663B14	1	
9	L-wrench	A031000	1	
10	Seal	A010003N	1	
11	Aerator	40.0003.000	1	
12	Aerator housing	A305641E	1	
13	Inlet hose(H)	TAQ-PEX-DN6-ACB H3/8-M8X1 L12-650-R-QB	1	
14	Inlet hose(C)	TAQ-PEX-DN6-ACB H3/8-M8X1 L12-650-QB	1	
15	Connectors	A668322	1	



Certificado de conformidad sanitaria.
Atestado de conformidade sanitária.
certificato di conformità sanitaria.
Βεβαίωση υγειονομικής συμμόρφωσης.
Certyfikat zgodności sanitarnej.
Декларация о соответствии санитарным нормам
Санитарлық талаптарға сәйкестік декларациясы
Декларация про відповідність санітарним нормам
Atestat de conformitate sanitară
Certificado de conformidade sanitária.
Declaration of sanitary conformity.
Attestation de conformité sanitaire

* Garantie 10 ans / 10 años de garantía / Garantía de 10 años / Garanzia 10 Anni / Εγγύηση 10 ετών / Gwarancja 10-letnia / Гарантія 10 років / Кеніздік 10 жыл / Гарантія 10 років /
Garantje 10 ani / 10 anos de garantía / 10-year guarantee

Made in P.R.C. 2018

ADEO Services - 135 Rue Sadi Carnot - CS 00001
59790 RONCHIN - France



ТОВ «Леруа Мерлен Україна»,
вул. Полярна 17а, м. Київ 04201, Україна

