

EAN CODE : 3276000592501

**FR** Manuel d'Instructions

**ES** Manual de Instrucciones

**PT** Manual de Instruções

**IT** Manuale di Istruzioni

**EL** Εγχειρίδιο Οδηγών

**PL** Instrukcja Obsługi

**RU** Руководства по  
Эксплуатации

**KZ** Пайдаланушы Нұсқаулығы

**UA** Інструкція з Експлуатації

**RO** Manual de Instrucțiuni

**BR** Manual de Instruções

**EN** Instructions Manual

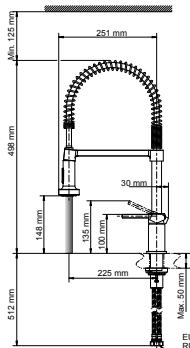

EU: F G3/8"-12/17  
RU: F G1/2"-15/21  
BR: F G1/2"-15/21

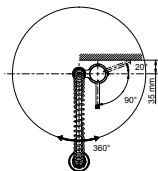
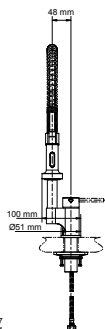

**B**

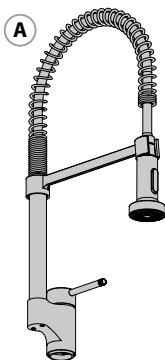

**A**



**C**

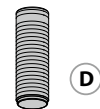

**D**



**E**



**F**



**G1**



**G2**



**H**



**I**

**BR**

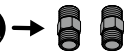

PH2  
↻





FR: Préparation / ES: Preparación / PT: Preparação / IT: Preparazione / EL: Προετοιμασία /  
PL: Przygotowanie / RU: Подготовка / KZ: Дайындау / UA: Підготовка / RO: Pregătire / BR: Preparação /  
EN: Preparation



FR: Montage / ES: Montaje / PT: Montagem / IT: Montaggio / EL: Συναρμολόγηση /  
PL: Montaż / RU: Сборка / KZ: Монтаждау / UA: Збірка / RO: Montaj / BR: Montagem /  
EN: Assembly



FR: Utilisation eau chaude-eau froide/ ES: Utilización agua caliente-agua fría/ PT: Utilização água quente-água fria/  
IT: Uso acqua calda-acqua fredda/ EL: Χρήση ζεστού-κρύου νερού/ PL: Użytkowanie zimnej wody-gorącej wody/  
RU: Використання гарячої води/ KZ: Суық және ыстық суды қолдану/ UA: води - холодної води/  
RO: Utilizare apă caldă-apă rece/ BR: Uso de água quente e fria/ EN: Using hot and cold water



FR: Changement de cartouche/ ES: Cambio de cartucho/ PT: Mudança de cartucho/ IT: Cambio cartuccia/  
EL: Αλλαγή φυσιγγίου/ PL: Wymiana wkładu/ RU: Смена картриджа/ KZ: Картриджі ауыстыру/  
UA: Заміна картриджа/ RO: Schimbare cartuş/ BR: Substituição de cartucho/ EN: Replacing the cartridge

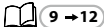

FR: Changement de mousseur/ ES: Cambio de aireador/ PT: Mudança de arejador/ IT: Cambio rompigoetto/  
EL: Αλλαγή αεράτορα/ PL: Wymiana perlatora/ RU: Смена аэратора/ KZ: Ауақанықтырғышты ауыстыру/  
UA: Заміна аератора/ RO: Schimbare aerator/ BR: Substituição do aerador/ EN: Replacing the aerator



FR: Changement de flexibles/ ES: Cambio de flexibles / PT: Mudança de flexíveis/ IT: Cambio flessibili/  
EL: Αλλαγή λάστιχων/ PL: Wymiana wężyków instalacyjnych / RU: Смена гибкого шланга для смесителя/  
KZ: Қоспауышқа арналған иілгіш шлангты ауыстыру/ UA: Заміна гнучкого шланга для змішувача/  
RO: Schimbare furtune flexibile/ BR: Substituição das mangueiras/ EN: Replacing the hoses

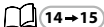



FR: Préparation / ES: Preparación / PT: Preparação / IT: Preparazione / EL: Προετοιμασία /  
PL: Przygotowanie / RU: Подготовка / KZ: Дайындау / UA: Підготовка / RO: Pregătire /  
BR: Preparação / EN: Preparation

1

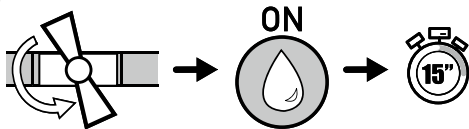

2

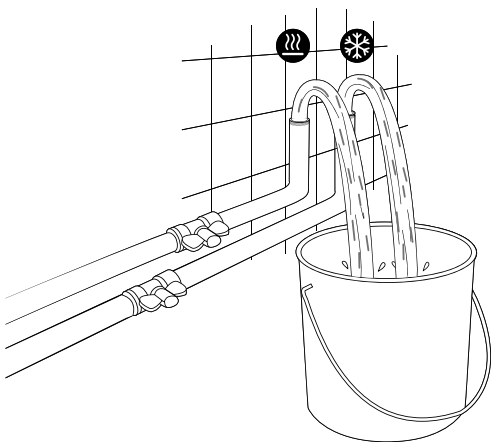

3

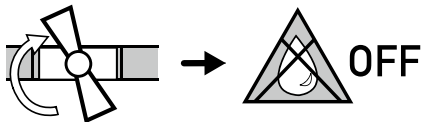



FR: Montage / ES: Montaje / PT: Montagem / IT: Montaggio / EL: Συναρμολόγηση /  
PL: Montaż / RU: Сборка / KZ: Монтаждау / UA: Збірка / RO: Montaj / BR: Montagem /  
EN: Assembly

B

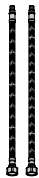

C



D



1

1

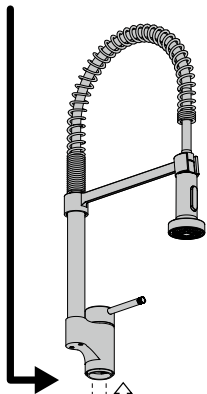
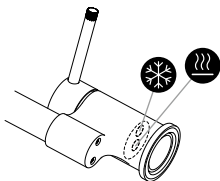

D

B

2

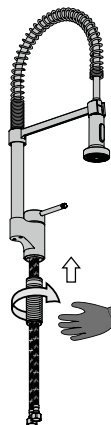

3

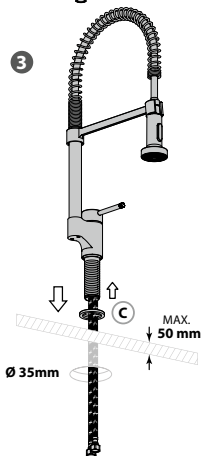

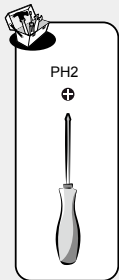
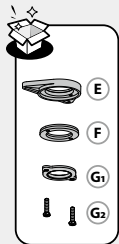

2

1

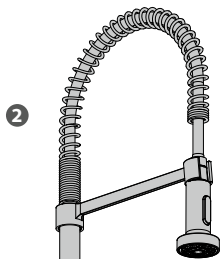

2

3

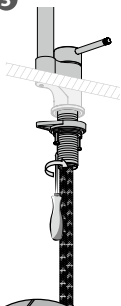

E

F

G

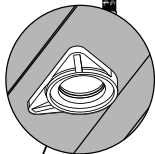

E



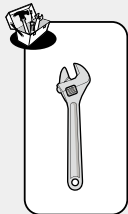

3

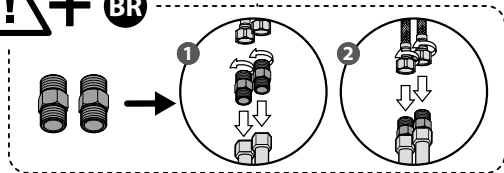
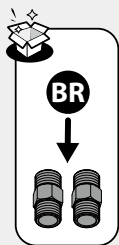
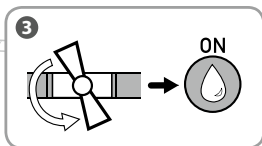
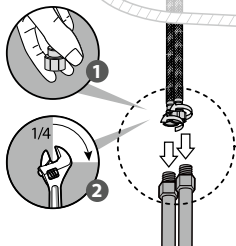
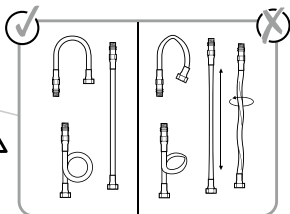
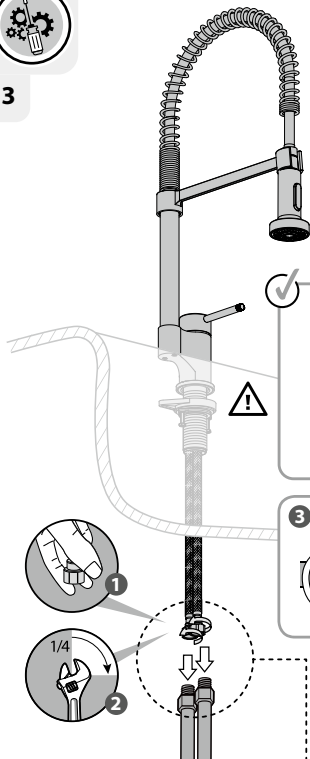



FR: Utilisation eau chaude-eau froide/ ES: Utilización agua caliente-agua fría/ PT: Utilização água quente-água fria/  
IT: Uso acqua calda-acqua fredda/ EL: Χρήση ζεστόύ-κρύου νερού/ PL: Użytkowanie zimnej wody-gorącej wody/  
RU: Використання гарячої води/ KZ: Суық және ыстық суды қолдану/ UA: води - холодної води/  
RO: Utilizare apă caldă-apă rece/ BR: Uso de água quente e fria/ EN: Using hot and cold water

1

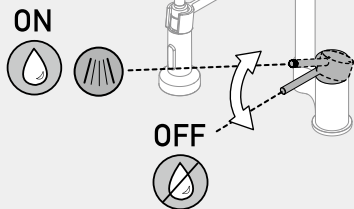
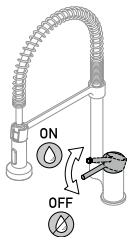

2

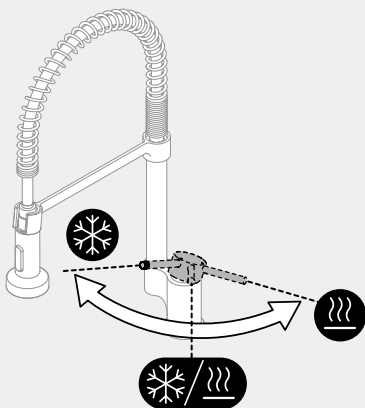





FR: Changement de cartouche/ ES: Cambio de cartucho/ PT: Mudança de cartucho/ IT: Cambio cartuccia/  
EL: Αλλαγή φουγγιού/ PL: Wymiana wkładu / RU: Смена картриджа/ KZ: Картриджа ауыстыру/  
UA: Заміна картриджа/ RO: Schimbare cartus/ BR: Substituição de cartucho/ EN: Replacing the cartridge

1

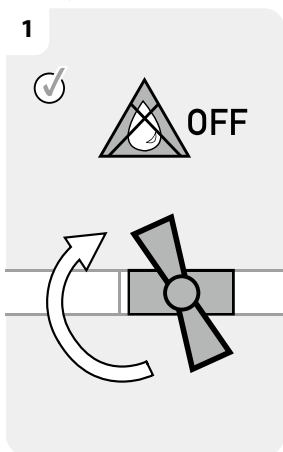

2

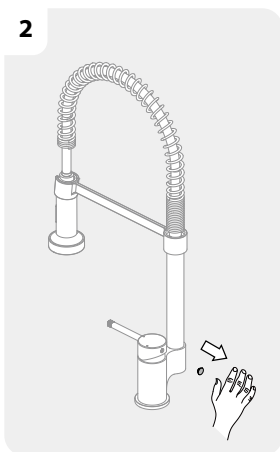

3

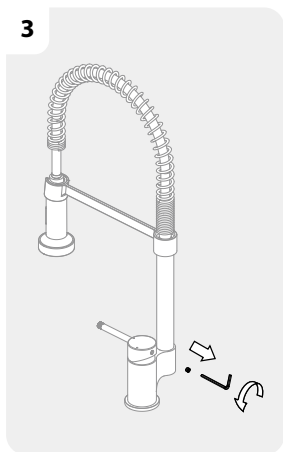

4

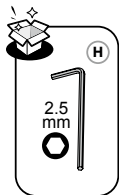
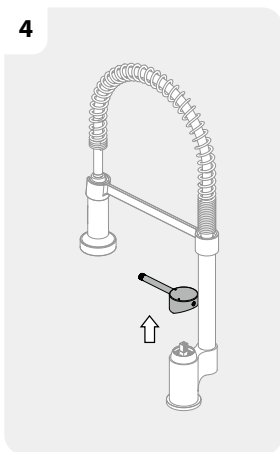



**FR:** Changement de cartouche/ **ES:** Cambio de cartucho/ **PT:** Mudança de cartucho/ **IT:** Cambio cartuccia/  
**EL:** Αλλαγή φουγγιού/ **PL:** Wymiana wkładu/ **RU:** Смена картриджа/ **KZ:** Картриджді ауыстыру/  
**UA:** Заміна картриджа/ **RO:** Schimbare cartus/ **BR:** Substituição de cartucho/ **EN:** Replacing the cartridge

5

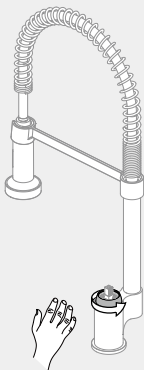

6

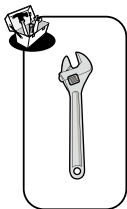
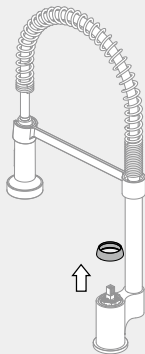

7

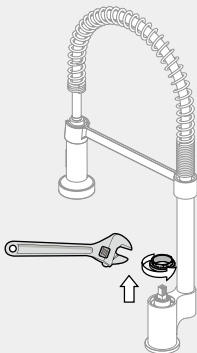

8

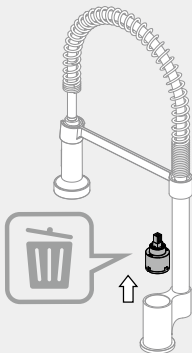

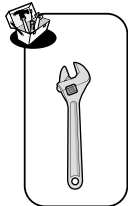

FR: Changement de cartouche/ ES: Cambio de cartucho/ PT: Mudança de cartucho/ IT: Cambio cartuccia/  
EL: Αλλαγή φουγγιού/ PL: Wymiana wkładu/ RU: Смена картриджа/ KZ: Картриджа ауыстыру/  
UA: Заміна картриджа/ RO: Schimbare cartus/ BR: Substituição de cartucho/ EN: Replacing the cartridge

9

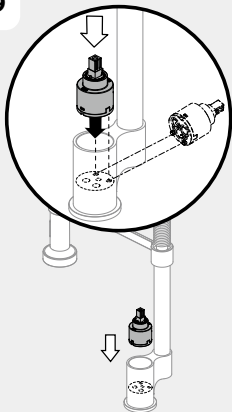

10

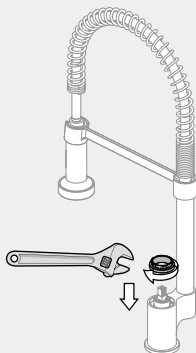

11

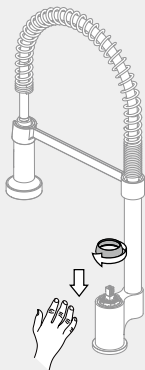

12

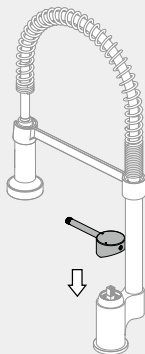

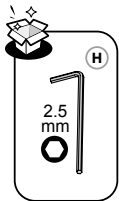

FR: Changement de cartouche/ ES: Cambio de cartucho/ PT: Mudança de cartucho/ IT: Cambio cartuccia/  
EL: Αλλαγή φουσιγγίου/ PL: Wymiana wkładu / RU: Смена картриджа/ KZ: Картриджа ауыстыру/  
UA: Заміна картриджа/ RO: Schimbare cartus/ BR: Substituição de cartucho/ EN: Replacing the cartridge

13

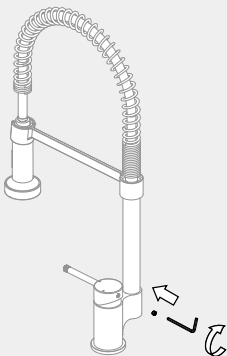

14

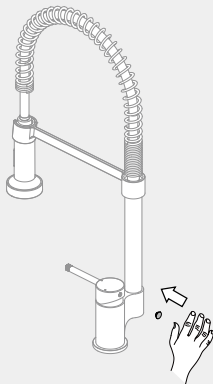

15

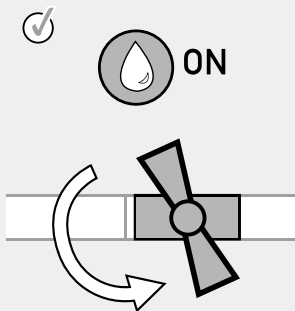

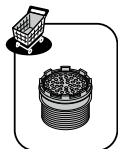
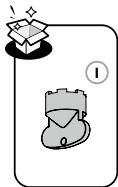

FR: Changement de mousseur/ ES: Cambio de aireador/ PT: Mudança de arejador/ IT: Cambio rompighetto/  
 EL: Αλλαγή αεράτορα/ PL: Wymiana perlatora/ RU: Смена аэратора/ KZ: Ауақаныңқырғышты ауыстыру/  
 UA: Заміна аератора/ RO: Schimbare aerator/ BR: Substituição do aerador/ EN: Replacing the aerator

1

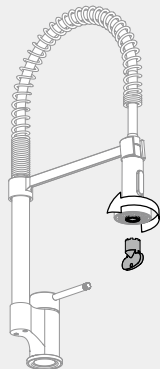

2

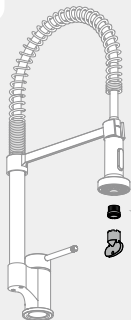

FR Nettoyage EL Καθαρισμός UA Очищення  
 ES Limpieza PL Czyszczenie RO Curatere  
 PT Limpeza RU Чистка BR Limpeza  
 IT Pulizia KZ тазарту EN Cleaning

3

FR Vinaigre IT Aceto RU Уксус RO Oțet  
 ES Vinagre EL Ξίδι KZ Сірке су BR Vinagre  
 PT Vinagre PL Ocet UA Оцет EN Vinegar

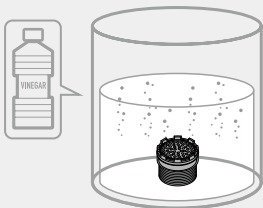

4

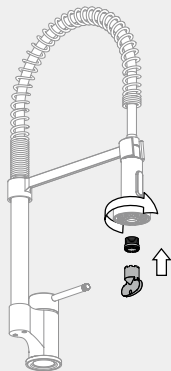

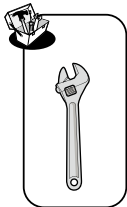

FR: Changement de flexibles/ ES: Cambio de flexibles/ PT: Mudança de flexíveis/ IT: Cambio flessibili/  
EL: Αλλαγή λάστιχων/ PL: Wymiana wężyków instalacyjnych / RU: Смена гибкого шланга для смесителя/  
KZ: Қоспауышқа арналған иілгіш шлангты ауыстыру/ UA: Заміна гнучкого шланга для змішувача/  
RO: Schimbare furtune flexibile/ BR: Substituição das mangueiras/ EN: Replacing the hoses

1



OFF

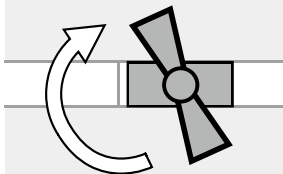

2

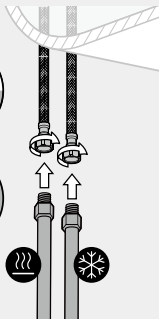

3

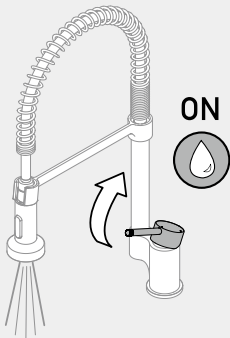

4

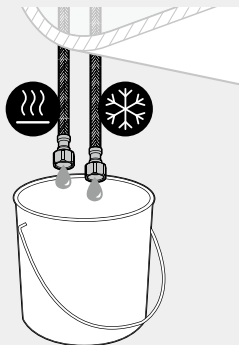

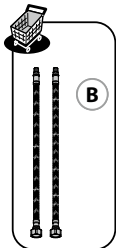

FR: Changement de flexibles/ ES: Cambio de flexibles/ PT: Mudança de flexíveis/ IT: Cambio flessibili/  
 EL: Αλλαγή λάστιχων/ PL: Wymiana wężyków instalacyjnych/ RU: Смена гибкого шланга для смесителя/  
 KZ: Қоспауышқа арналған иілгіш шлангты ауыстыру/ UA: Заміна гнучкого шланга для змішувача/  
 RO: Schimbare furtune flexibile/ BR: Substituição das mangueiras/ EN: Replacing the hoses

5

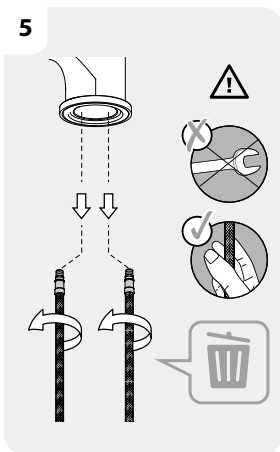

6

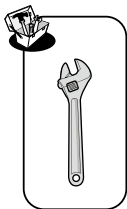
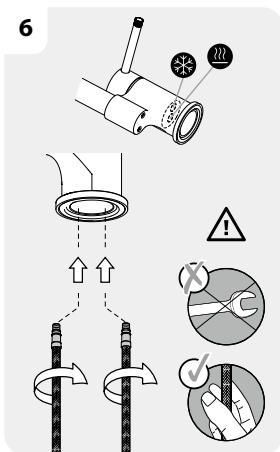

7

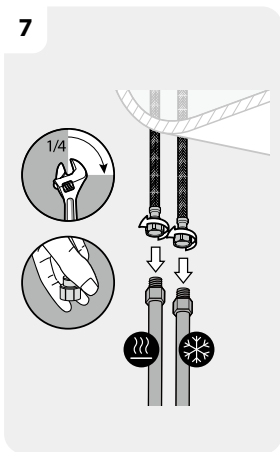

8

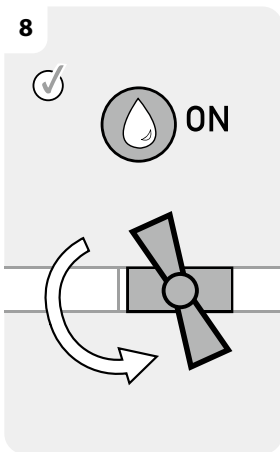



Eau claire / Agua limpia / Água limpa / Acqua pulita / Καθαρό νερό / Czysta woda / Чистая вода / Sem solventes /  
Чиста вода / Apă curată / Agua limpa / Clean water



Sans solvant / Sin disolvente / Sem solventes / Senza solventi / Χωρίς διαλυτικά / Bez rozpuszczalnika / Без растворителя /  
еріткішсіз / Без розчинника / Fără solvent / таза су / Solvent-free

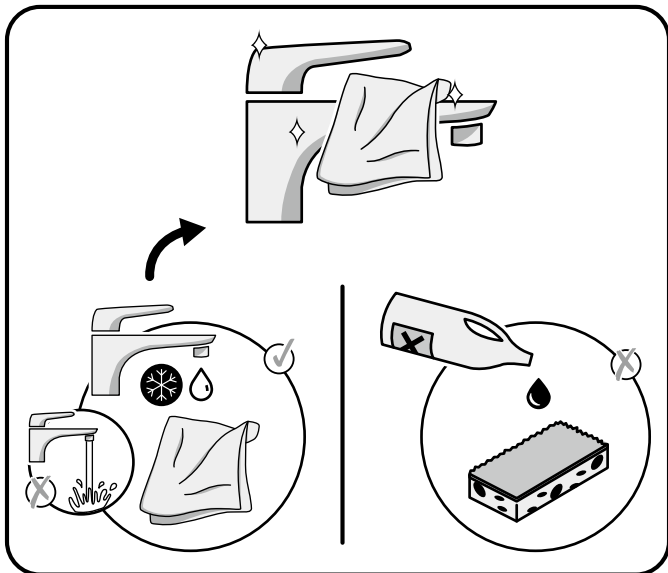



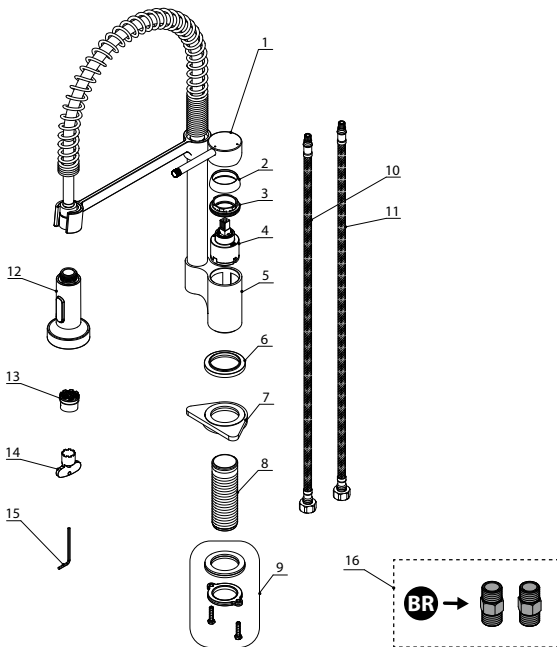

| NO. | Description         | Code No.                               | QTY | Remark |
|-----|---------------------|--|-----|--------|
| 1   | Handle              | A662A89                                | 1   |        |
| 2   | Beautifying cover   | A103121                                | 1   |        |
| 3   | Compressing nut     | A104378                                | 1   |        |
| 4   | Cartridge           | EN-35 S/D ENDURA COLD C110             | 1   |        |
| 5   | Body spout assembly | 033135-AX                              | 1   |        |
| 6   | Base ring           | A66F511CP-P                            | 1   |        |
| 7   | Plastic triangle    | A663B13                                | 1   |        |
| 8   | Easy fix shank      | A035045                                | 1   |        |
| 9   | Fixing kit          | A663B16                                | 1   |        |
| 10  | Inlet hose (H)      | TAQ-PEX-DN6-ACB H3/8-M8x1 L12-550-R-QB | 1   |        |
| 11  | Inlet hose (C)      | TAQ-PEX-DN6-ACB H3/8-M8x1 L12-550-QB   | 1   |        |
| 12  | Shower head         | K2130                                  | 1   |        |
| 13  | Aerator             | 44.2300.010                            | 1   |        |
| 14  | Aerator key         | 09.9150.0                              | 1   |        |
| 15  | L-wrench            | A031000                                | 1   |        |
| 16  | Connectors          | A668322                                | 1   |        |







Certificado de conformidad sanitaria.  
Atestado de conformidade sanitária.  
certificato di conformità sanitaria.  
Βεβαίωση υγειονομικής συμμόρφωσης.  
Certyfikat zgodności sanitarnej.  
Декларация о соответствии санитарным нормам  
Санитарлық талаптарға сәйкестік декларациясы  
Декларация про відповідність санітарним нормам  
Atestat de conformitate sanitară  
Certificado de conformidade sanitária.  
Declaration of sanitary conformity.  
Attestation de conformité sanitaire

\* Garantie 10 ans / 10 años de garantía / Garantía de 10 años / Garanzia 10 Anni / Εγγύηση 10 ετών / Gwarancja 10-letnia / Гарантія 10 год / Кенідік 10 жыл / Гарантія 10 років /  
Garantje 10 ani / 10 anos de garantía / 10-year guarantee

Made in P.R.C. 2018

ADEO Services - 135 Rue Sadi Carnot - CS 00001  
59790 RONCHIN - France



ТОВ «Леруа Мерлен Україна»,  
вул. Полярна 17а, м. Київ 04201, Україна

