

delinia

Guarantee
10
years

GORDON

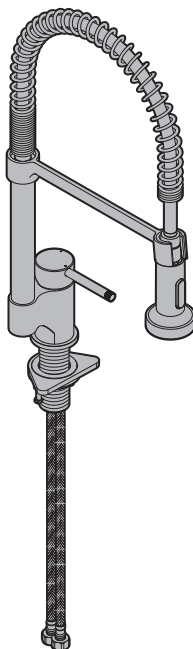

EAN CODE : 3276000592501

FR Manuel d'Instructions

ES Manual de Instrucciones

PT Manual de Instruções

IT Manuale di Istruzioni

EL Εγχειρίδιο Οδηγών

PL Instrukcja Obsługi

RU Руководства по
Эксплуатации

KZ Пайдаланушы Нұсқаулығы

UA Інструкція з Експлуатації

RO Manual de Instrucțiuni

BR Manual de Instruções

EN Instructions Manual

2020/05/01

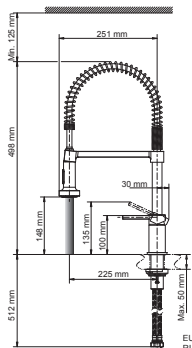

EU: F G3/8"-12/17
RU: F G1/2"-15/21
BR: F G1/2"-15/21

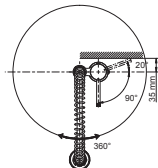
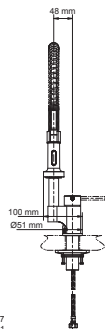

B

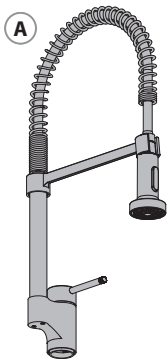

A



C

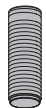

D



E



F



G1



G2



H



I

BR



PH2



30'





FR: Préparation / ES: Preparación / PT: Preparação / IT: Preparazione / EL: Προετοιμασία /
PL: Przygotowanie / RU: Подготовка / KZ: Дайындау / UA: Підготування / RO: Pregătire / BR: Preparação /
EN: Preparation



FR: Montage / ES: Montaje / PT: Montagem / IT: Montaggio / EL: Συναρμολόγηση /
PL: Montaż / RU: Сборка / KZ: Монтаждау / UA: Збірка / RO: Montaj / BR: Montagem /
EN: Assembly



FR: Utilisation eau chaude-eau froide/ ES: Utilización agua caliente-agua fría/ PT: Utilização água quente-água fria/
IT: Uso acqua calda-acqua fredda/ EL: Χρήση ζεστής-κρύου νερού/ PL: Użytkowanie zimnej wody-gorącej wody/
RU: Використання гарячої води/ KZ: Суық және ыстық суды қолдану/ UA: води - холодної води/
RO: Utilizare apă caldă-apă rece/ BR: Uso de água quente e fria/ EN: Using hot and cold water



FR: Changement de cartouche/ ES: Cambio de cartucho/ PT: Mudança de cartucho/ IT: Cambio cartuccia/
EL: Αλλαγή φωτογείου/ PL: Wymiana wkładu/ RU: Смена картриджа/ KZ: Картриджді ауыстыру/
UA: Заміна картриджа/ RO: Schimbare cartus/ BR: Substituição de cartucho/ EN: Replacing the cartridge



FR: Changement de mousseur/ ES: Cambio de aireador/ PT: Mudança de arejador/ IT: Cambio rompigetto/
EL: Αλλαγή αεράτορα/ PL: Wymiana perlatora/ RU: Смена аэратора/ KZ: Ауақанықтырғышты ауыстыру/
UA: Заміна аератора/ RO: Schimbare aerator/ BR: Substituição do aerador/ EN: Replacing the aerator



FR: Changement de flexibles/ ES: Cambio de flexibles / PT: Mudança de flexíveis/ IT: Cambio flessibili/
EL: Αλλαγή λάστιχων/ PL: Wymiana wężyków instalacyjnych / RU: Смена гибкого шланга для смесителя/
KZ: Қоспауышқа арналған иілгіш шлангты ауыстыру/ UA: Заміна гнучкого шланга для змішувача/
RO: Schimbare furtune flexibile/ BR: Substituição das mangueiras/ EN: Replacing the hoses





FR: Préparation / ES: Preparación / PT: Preparação / IT: Preparazione / EL: Προετοιμασία /
PL: Przygotowanie / RU: Подготовка / KZ: Дайындау / UA: Підготовка / RO: Pregătire /
BR: Preparação / EN: Preparation

1

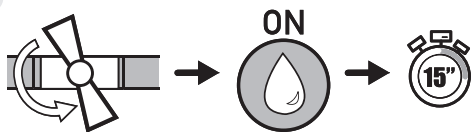

2

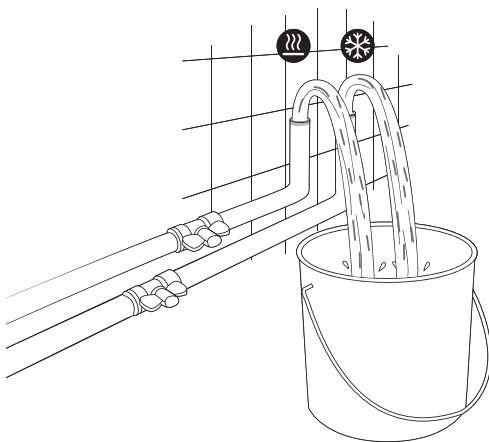

3

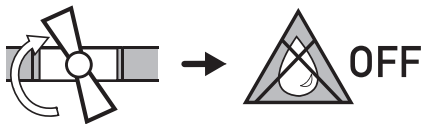

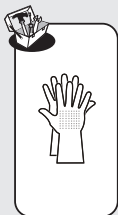
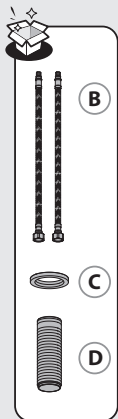

FR: Montage / ES: Montaje / PT: Montagem / IT: Montaggio / EL: Συνομιολόγηση /
 PL: Montaż / RU: Сборка / KZ: Монтаж/дау / UA: Збірка / RO: Montaj / BR: Montagem /
 EN: Assembly

1

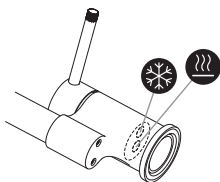

1

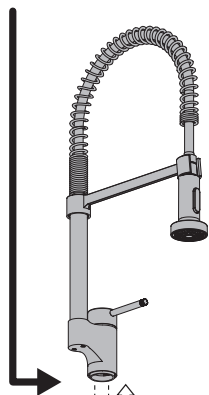

2

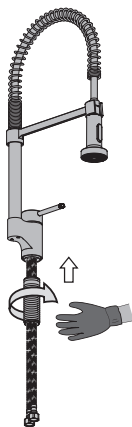

3

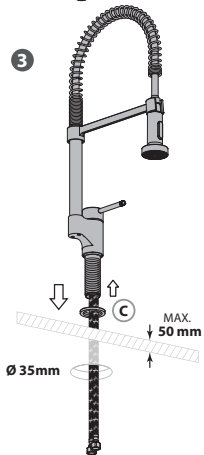

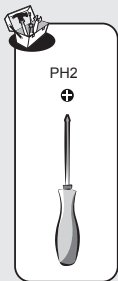

2

1

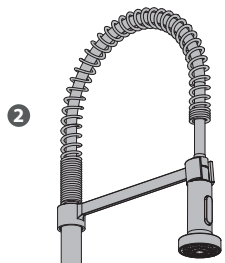
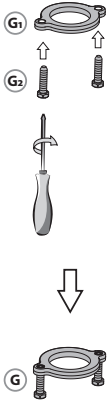

2

3

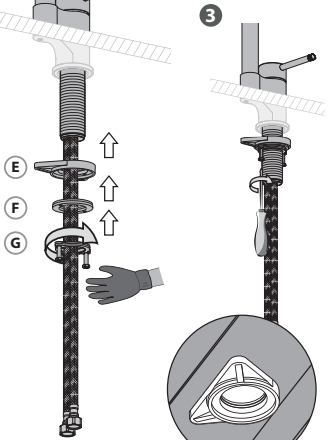

E

F

G

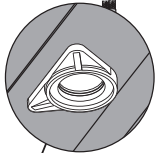

E





3

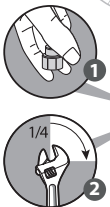
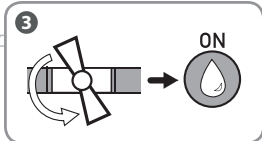
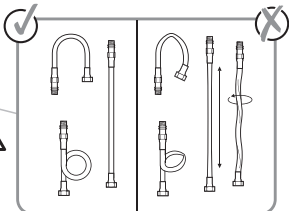
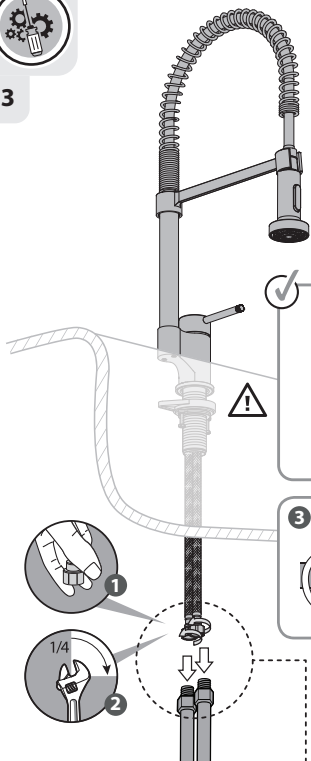

BR

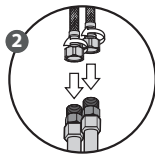
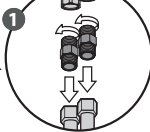



FR: Utilisation eau chaude-eau froide/ ES: Utilización agua caliente-agua fría/ PT: Utilização água quente-água fria/
IT: Uso acqua calda-acqua fredda/ EL: Χρήση ζεστού-κρύου νερού/ PL: Użytkowanie zimnej wody-gorącej wody/
RU: Використання гарячої води/ KZ: Суық және ыстық суы қолдану/ UA: води - холодної води/
RO: Utilizare apă caldă-apă rece/ BR: Uso de água quente e fria/ EN: Using hot and cold water

1

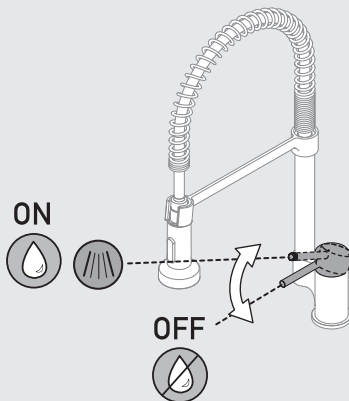
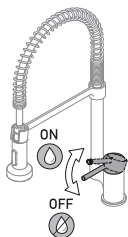

2

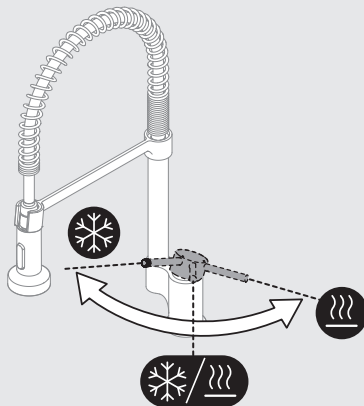
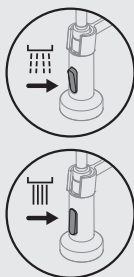



FR: Changement de cartouche/ ES: Cambio de cartucho/ PT: Mudança de cartucho/ IT: Cambio cartuccia/
EL: Αλλαγή φουσιγγίου/ PL: Wymiana wkładu/ RU: Смена картриджа/ KZ: Картриджкі ауыстыру/
UA: Заміна картриджа/ RO: Schimbare cartus/ BR: Substituição de cartucho/ EN: Replacing the cartridge

1

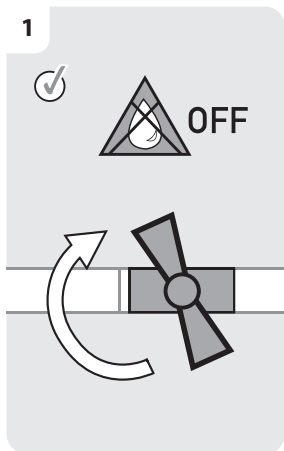

2

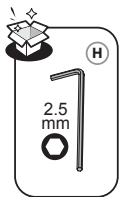
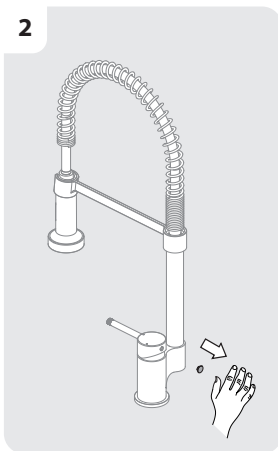

3

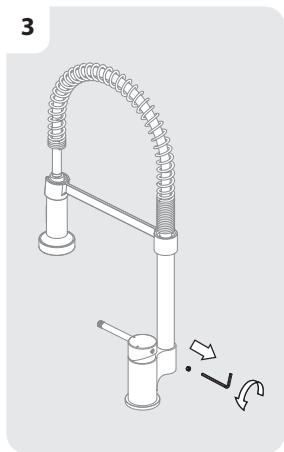

4

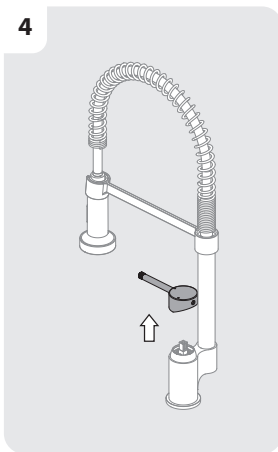



FR: Changement de cartouche/ ES: Cambio de cartucho/ PT: Mudança de cartucho/ IT: Cambio cartuccia/
EL: Αλλαγή φουγγιού/ PL: Wymiana wkładu/ RU: Смена картриджа/ KZ: Картриджкі ауыстыру/
UA: Заміна картриджа/ RO: Schimbare cartus/ BR: Substituição de cartucho/ EN: Replacing the cartridge

5

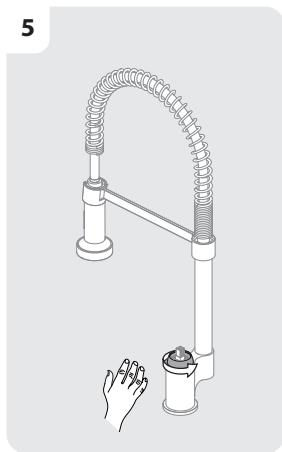

6

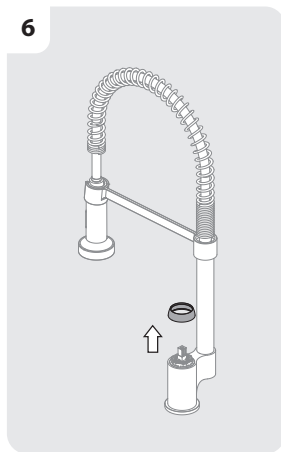

7

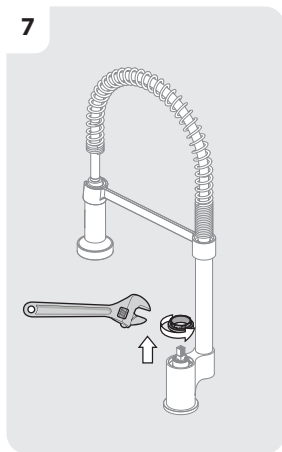

8

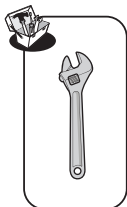
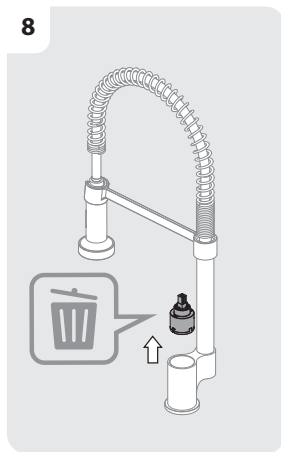

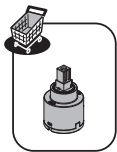
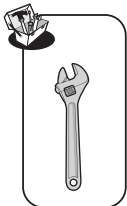

FR: Changement de cartouche/ ES: Cambio de cartucho/ PT: Mudança de cartucho/ IT: Cambio cartuccia/
EL: Αλλαγή φουσιγγίου/ PL: Wymiana wkładu/ RU: Смена картриджа/ KZ: Картриджкі ауыстыру/
UA: Заміна картриджа/ RO: Schimbare cartus/ BR: Substituição de cartucho/ EN: Replacing the cartridge

9

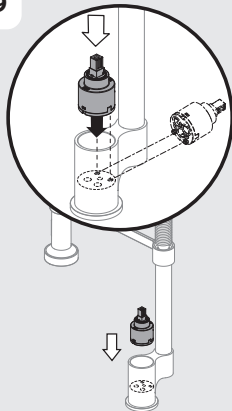

10

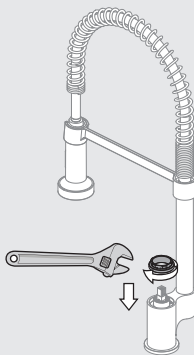

11

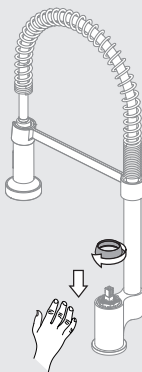

12

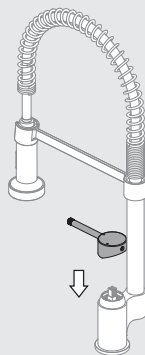

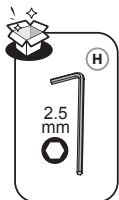

FR: Changement de cartouche/ ES: Cambio de cartucho/ PT: Mudança de cartucho/ IT: Cambio cartuccia/
EL: Αλλαγή φουσιγγιού/ PL: Wymiana wkładu/ RU: Смена картриджа/ KZ: Картриджкі ауыстыру/
UA: Заміна картриджа/ RO: Schimbare cartus/ BR: Substituição de cartucho/ EN: Replacing the cartridge

13

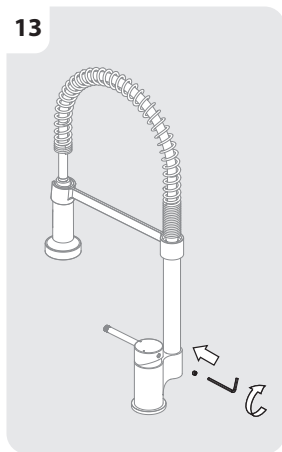

14

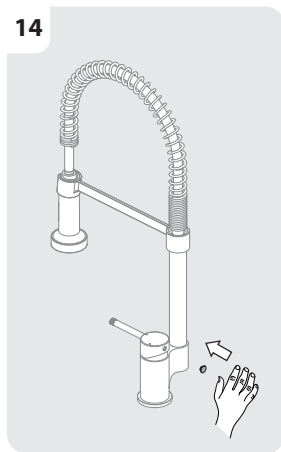

15

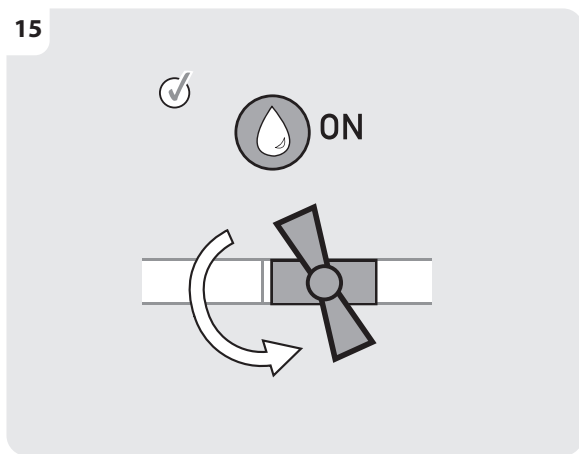

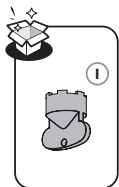

FR: Changement de mousseur/ ES: Cambio de aireador/ PT: Mudança de arejador/ IT: Cambio rompigetto/
 EL: Αλλαγή αεράτορα/ PL: Wymiana perlatora/ RU: Смена аэратора/ KZ: Ауақаныңтырғышты ауыстыру/
 UA: Заміна аератора/ RO: Schimbare aerator/ BR: Substituição do aerador/ EN: Replacing the aerator

1

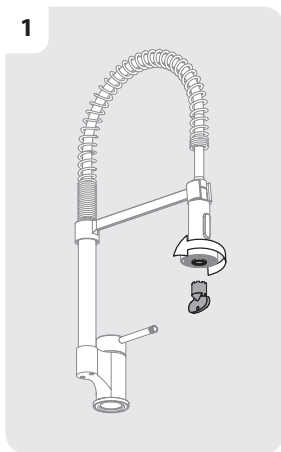

2

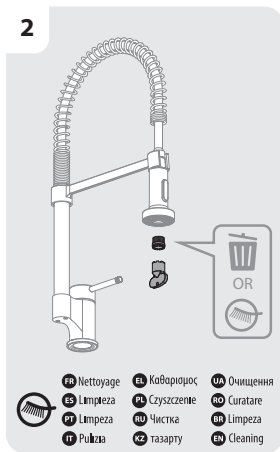

- | | | |
|--------------|----------------|-------------|
| 20 Nettoyage | 25 Καθαρισμός | 26 Очищення |
| 21 Limpeza | 27 Czystczenie | 28 Curatate |
| 22 Limpeza | 29 Чистка | 30 Limpeza |
| 23 Puhktaa | 32 тазарту | 33 Cleaning |

3

- | | | | |
|-------------|----------|-------------|------------|
| 34 Vinaigre | 37 Aceto | 38 Укус | 40 Oțet |
| 35 Vinagre | 39 Σόδι | 42 Сірке су | 44 Vinagre |
| 36 Vinagre | 41 Ocet | 43 Оцет | 45 Vinegar |

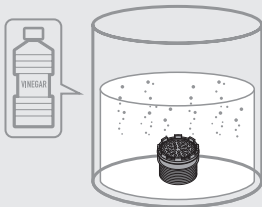

4

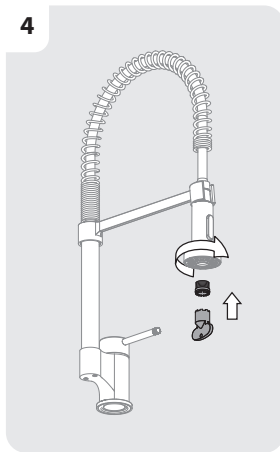

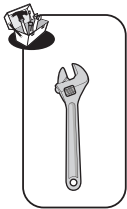

FR: Changement de flexibles/ ES: Cambio de flexibles/ PT: Mudança de flexíveis/ IT: Cambio flessibili/
EL: Αλλαγή λάστιχων/ PL: Wymiana wężyków instalacyjnych/ RU: Смена гибкого шланга для смеси/тепла/
KZ: Қоспауысқа арналған иілгіш шлангты ауыстыру/ UA: Заміна гнучкого шланга для змішувача/
RO: Schimbare furtune flexibile/ BR: Substituição das mangueiras/ EN: Replacing the hoses

1

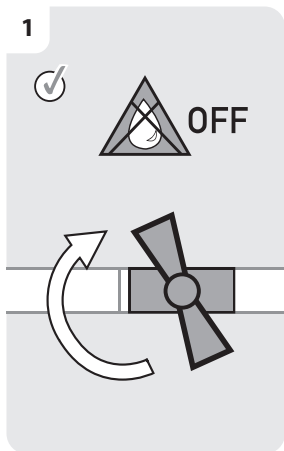

2

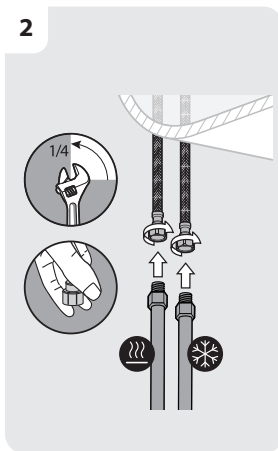

3

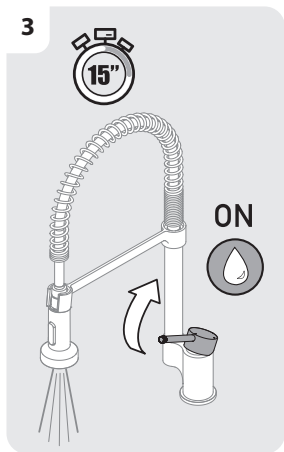

4

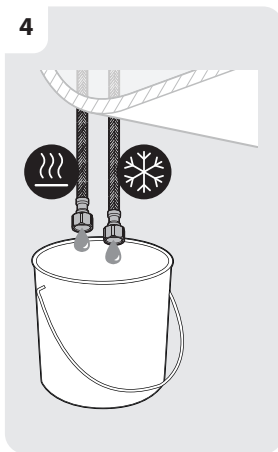

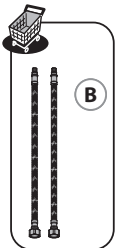

FR: Changement de flexibles/ ES: Cambio de flexibles/ PT: Mudança de flexíveis/ IT: Cambio flessibili/
 EL: Αλλαγή λάστιχων/ PL: Wymiana wężyków instalacyjnych/ RU: Замена гибкого шланга для смесителя/
 KZ: Қоспауысуға арналған иілгіш шлангты ауыстыру/ UA: Заміна гнучкого шланга для змішувача/
 RO: Schimbare furtune flexibile/ BR: Substituição das mangueiras/ EN: Replacing the hoses

5

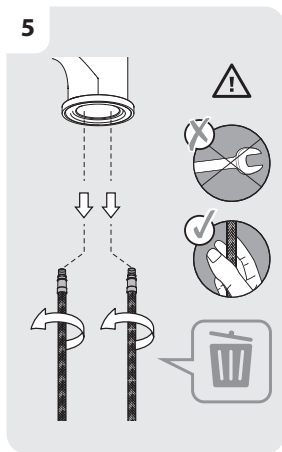

6

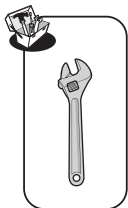
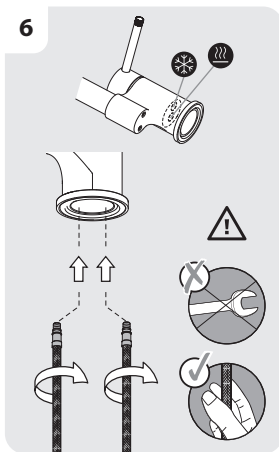

7

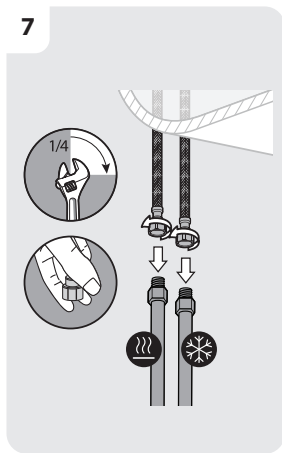

8

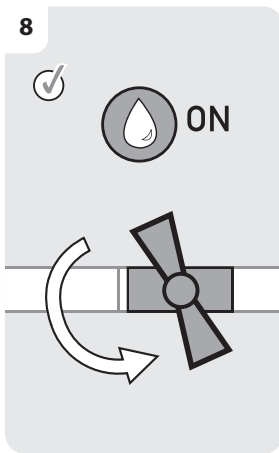



Eau claire / Agua limpia / Água limpa / Acqua pulita / Каваро веро / Czysta woda / Чистая вода / Sem solventes /
Чиста вода / Арă curată / Água limpa / Clean water



Sans solvant / Sin disolvente / Sem solventes / Senza solventi / Хуриç диалутикă / Bez rozpuszczalnika / Без растворителя /
еріткішçіç / Без розчинника / Fără solvent / таза су / Solvent-free

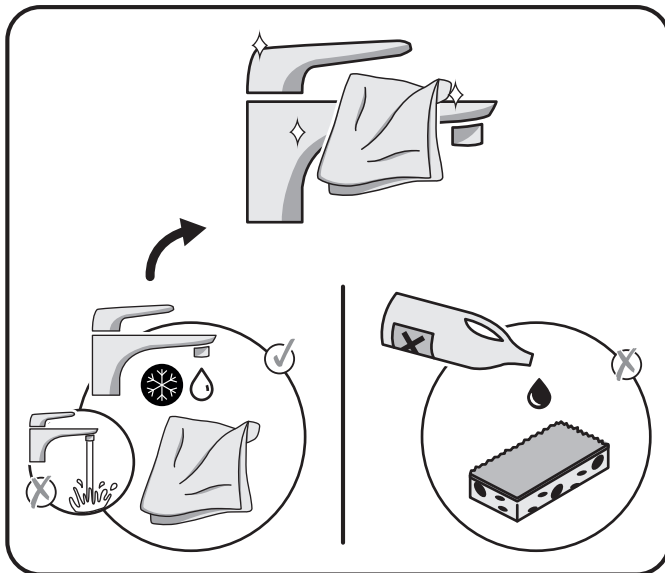

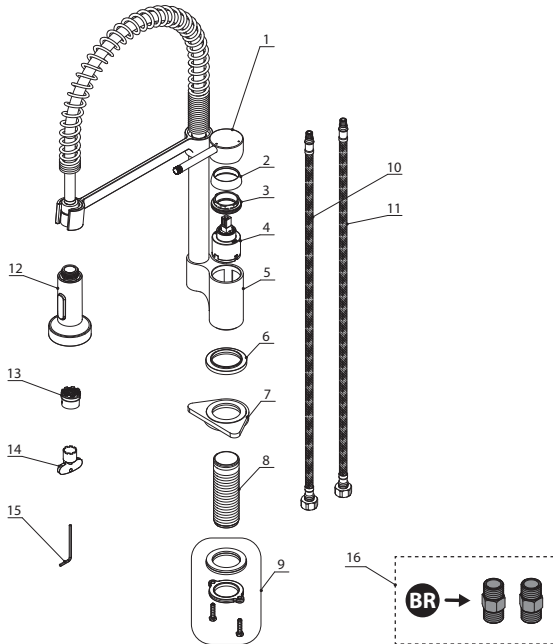

NO.	Description	Code No.	QTY	Remark
1	Handle	A662A89	1	
2	Beautifying cover	A103121	1	
3	Compressing nut	A104378	1	
4	Cartridge	EN-35 S/D ENDURA COLD C110	1	
5	Body spout assembly	033135-AX	1	
6	Base ring	A66F511CP-P	1	
7	Plastic triangle	A663B13	1	
8	Easy fix shank	A035045	1	
9	Fixing kit	A663B16	1	
10	Inlet hose (H)	TAQ-PEX-DN6-ACB H3/8-M8x1 L12-550-R-QB	1	
11	Inlet hose (C)	TAQ-PEX-DN6-ACB H3/8-M8x1 L12-550-QB	1	
12	Shower head	K2130	1	
13	Aerator	44.2300.010	1	
14	Aerator key	09.9150.0	1	
15	L-wrench	A031000	1	
16	Connectors	A668322	1	







Certificado de conformidad sanitaria.
Atestado de conformidade sanitária.
certificato di conformità sanitaria.
Βεβαίωση υγιεινότητας συμμόρφωσης.
Сертифікат згодності санітарної.
Декларация о соответствии санитарным нормам
Санитарлық талаптарға сәйкестік декларациясы
Декларация про відповідність санітарним нормам
Atestat de conformitate sanitară
Certificado de conformidade sanitária.
Declaration of sanitary conformity.
Attestation de conformité sanitaire

* Garantie 10 ans / 10 años de garantía / Garantia de 10 anos / Garanzia 10 Anni / Εγγύηση 10 ετών / Gwarancja 10-letnia / Гарантия 10 года / Келіңдік 10 жыл / Гарантія 10 років / Garantie 10 ani / 10 anos de garantia / 10-year guarantee

Made in P.R.C. 2018

ADEO Services - 135 Rue Sadi Carnot - CS 00001
59790 RONCHIN - France

UA ТОВ «Ітера Мерлен Україна»,
вул. Полірна 17а, м. Київ 04201, Україна

