

EAN CODE : 3276000592143

**FR** Manuel d'Instructions

**ES** Manual de Instrucciones

**PT** Manual de Instruções

**IT** Manuale di Istruzioni

**EL** Εγχειρίδιο Οδηγιών

**PL** Instrukcja Obsługi

**RU** Руководства по  
Эксплуатации

**KZ** Пайдаланушы Нұсқаулығы

**UA** Інструкція з Експлуатації

**RO** Manual de Instrucțiuni

**BR** Manual de Instruções

**EN** Instructions Manual

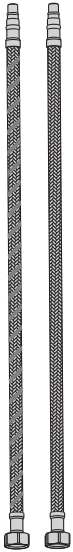
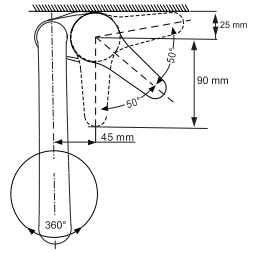
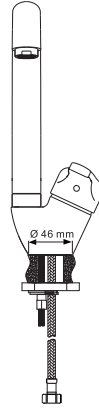
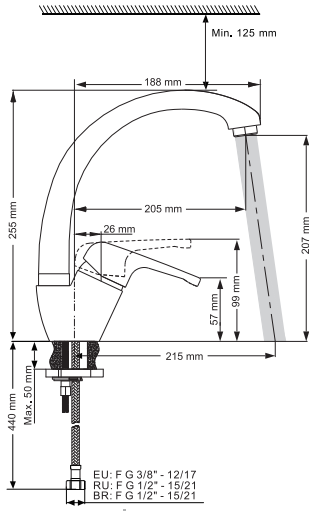

**B**

**A**

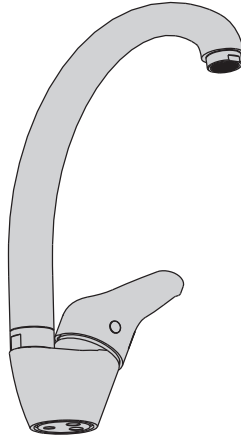

**C**



**D**



**E**



**F**



**G**



**H**

**BR**



+



11





**FR:** Préparation / **ES:** Preparación / **PT:** Preparação / **IT:** Preparazione / **EL:** Προετοιμασία /  
**PL:** Przygotowanie / **RU:** Подготовка / **KZ:** Дайындау / **UA:** Підготування / **RO:** Pregătire / **BR:** Preparação /  
**EN:** Preparation



4



**FR:** Montage / **ES:** Montaje / **PT:** Montagem / **IT:** Montaggio / **EL:** Συναρμολόγηση /  
**PL:** Montaż / **RU:** Сборка / **KZ:** Монтаждау / **UA:** Збірка / **RO:** Montaj / **BR:** Montagem /  
**EN:** Assembly



5 → 7



**FR:** Utilisation eau chaude-eau froide/ **ES:** Utilización agua caliente-agua fría/ **PT:** Utilização água quente-água fria/   
**IT:** Uso acqua calda-acqua fredda/ **EL:** Χρήση ζεστού-κρύου νερού/ **PL:** Użytkowanie zimnej wody-gorącej wody/   
**RU:** Використання гарячої води/ **UA:** води - холодної води/ **RO:** Utilizare apă caldă-apă rece/   
**EN:** Using hot and cold water



8

**FR:** Changement de cartouche/ **ES:** Cambio de cartucho/ **IT:** Cambio cartuccia/ **PT:** Mudança de cartucho/   
**EL:** Αλλαγή φυσιγγίου/ **PL:** Wymiana wkładu / **RU:** Смена картриджа/ **KZ:** Картриджді ауыстыру/   
**UA:** Заміна картриджа/ **RO:** Schimbare cartuş/ **BR:** Substituição de cartucho/ **EN:** Replacing the cartridge



9 → 12

**FR:** Changement de mousseur/ **ES:** Cambio de aireador/ **PT:** Mudança de arejador/ **IT:** Cambio rompigoetto/   
**EL:** Αλλαγή αεράτορα / **PL:** Wymiana perlatora / **RU:** Смена аэратора/ **KZ:** Ауақанықтырғышты ауыстыру/   
**UA:** Заміна аератора/ **RO:** Schimbare aerator/ **BR:** Substituição do aerador/ **EN:** Replacing the aerator



13

**FR:** Changement de flexibles/ **ES:** Cambio de flexibles / **PT:** Mudança de flexíveis/ **IT:** Cambio flessibili/   
**EL:** Αλλαγή λάστιχων/ **PL:** Wymiana wężyków instalacyjnych / **RU:** Смена гибкого шланга для смесителя/   
**UA:** Заміна гнучкого шланга для змішувача/ **KZ:** Қоспалауышқа арналған иілгіш шлангты ауыстыру/   
**RO:** Schimbare furtune flexibil/ **BR:** Substituição das mangueiras/ **EN:** Replacing the hoses



14 → 15



FR: Préparation / ES: Preparación / PT: Preparação / IT: Preparazione / EL: Προετοιμασία /  
PL: Przygotowanie / RU: Подготовка / KZ: Дайындау / UA: Підготування / RO: Pregătire /  
BR: Preparação / EN: Preparation

1

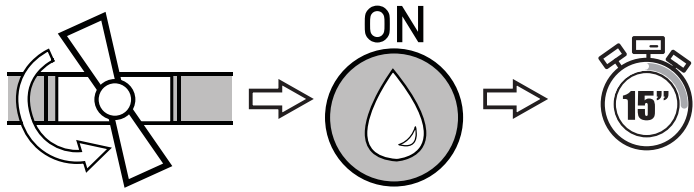

2

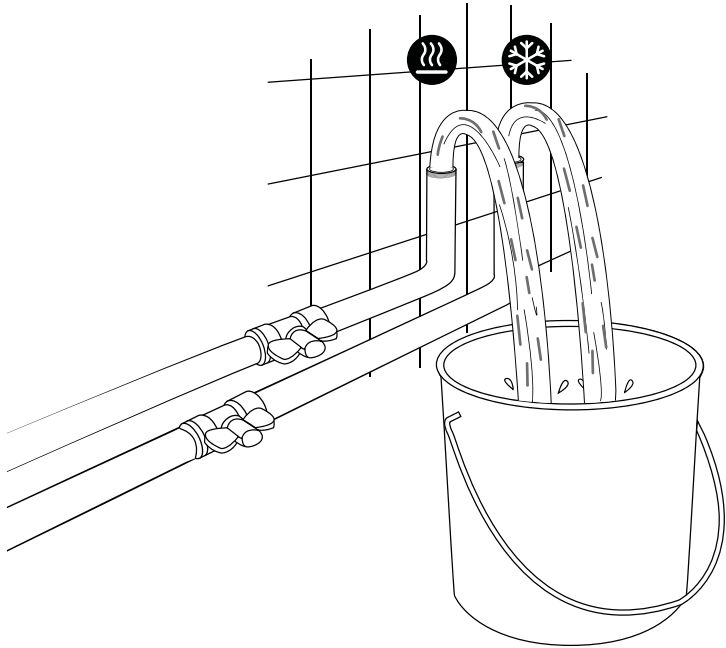

3

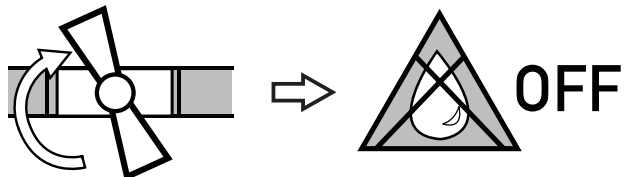



FR: Montage / ES: Montaje / PT: Montagem / IT: Montaggio / EL: Συναρμολόγηση /  
PL: Montaż / RU: Сборка / KZ: Монтаждау / UA: Збірка / RO: Montaj / BR: Montagem /  
EN: Assembly

1

1

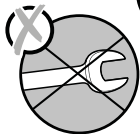
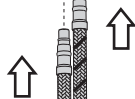
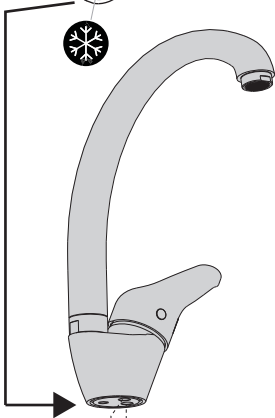
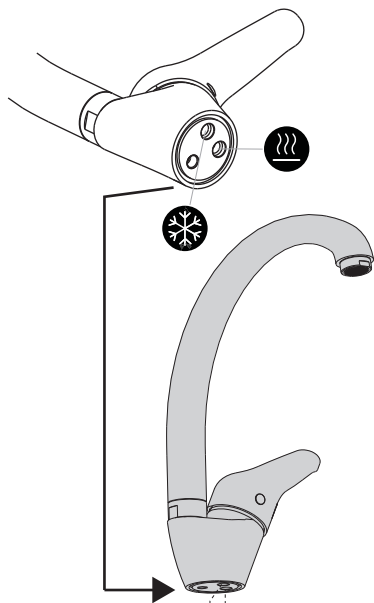

B



2

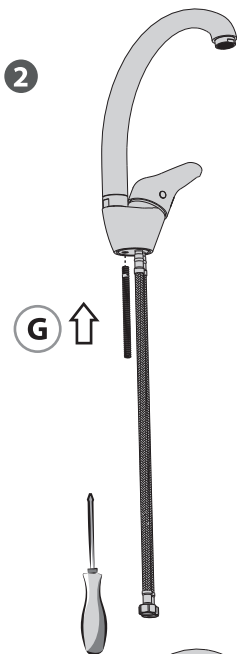

G

3

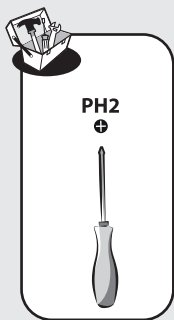
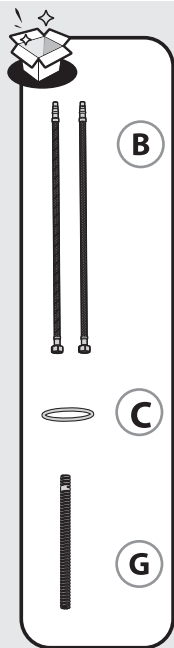
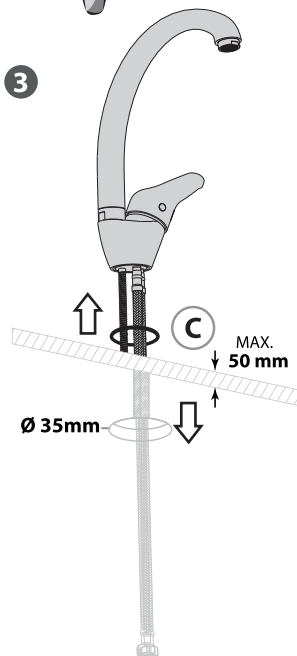

PH2



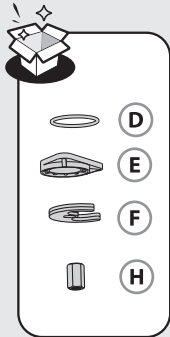

2

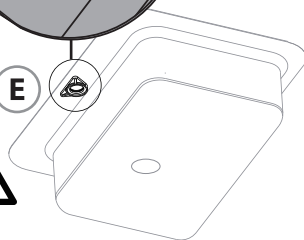
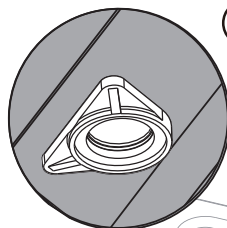
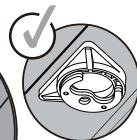
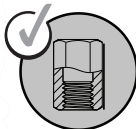
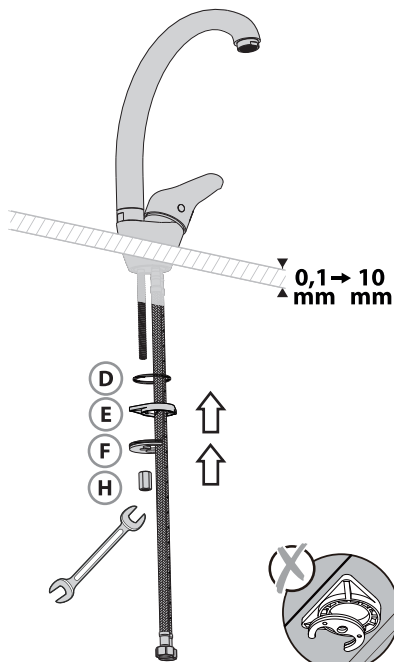
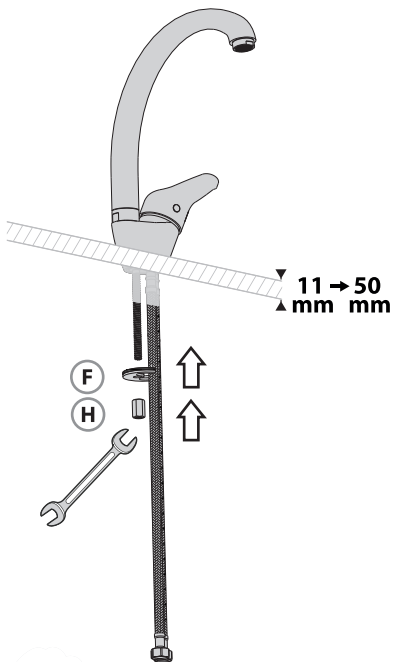
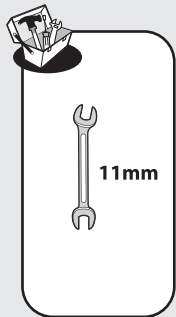
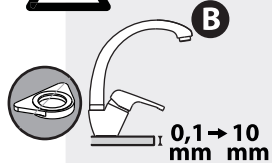
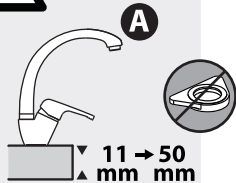

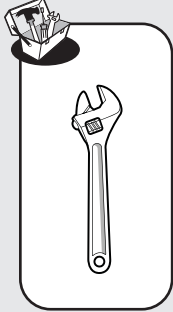

3

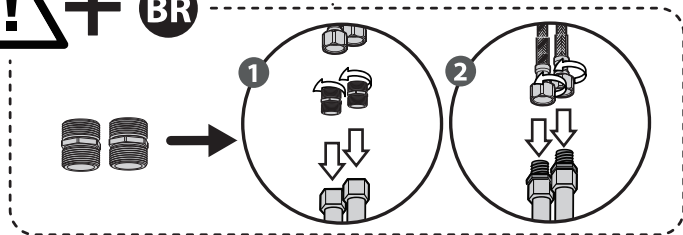
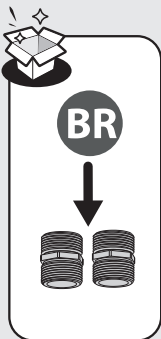
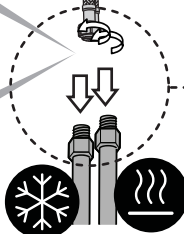
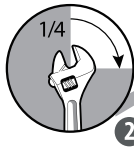
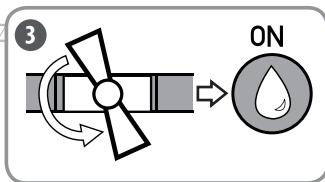
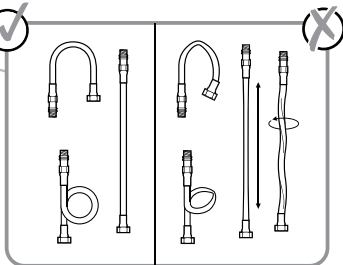
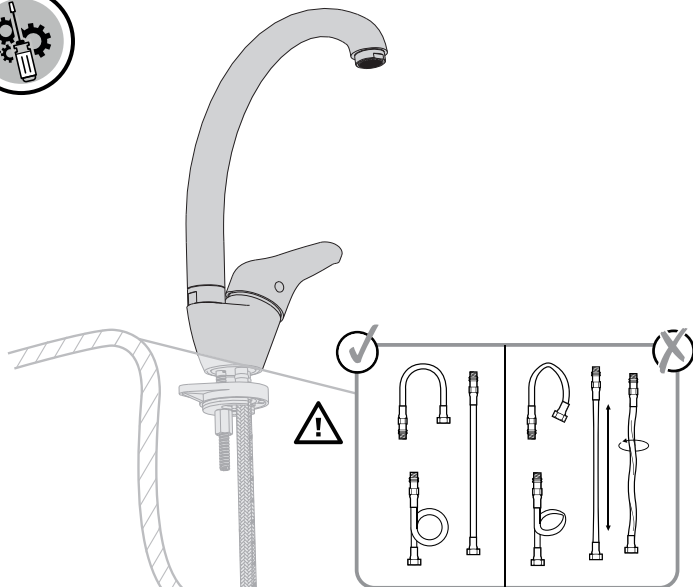



**FR:** Utilisation eau chaude-eau froide/ **ES:** Utilización agua caliente-agua fría/ **PT:** Utilização água quente-água fria/  
**IT:** Uso acqua calda-acqua fredda/ **EL:** Χρήση ζεστού-κρύου νερού/ **PL:** Użytkowanie zimnej wody-gorącej wody/  
**RU:** Використання гарячої води/ **KZ:** Суық және ыстық суды қолдану/ **UA:** води - холодної води/  
**RO:** Utilizare apă caldă-apă rece/ **BR:** Uso de água quente e fria/ **EN:** Using hot and cold water

1

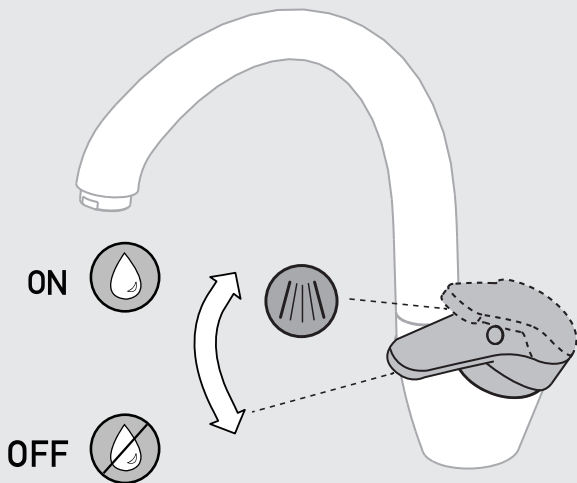
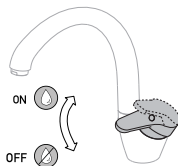

2

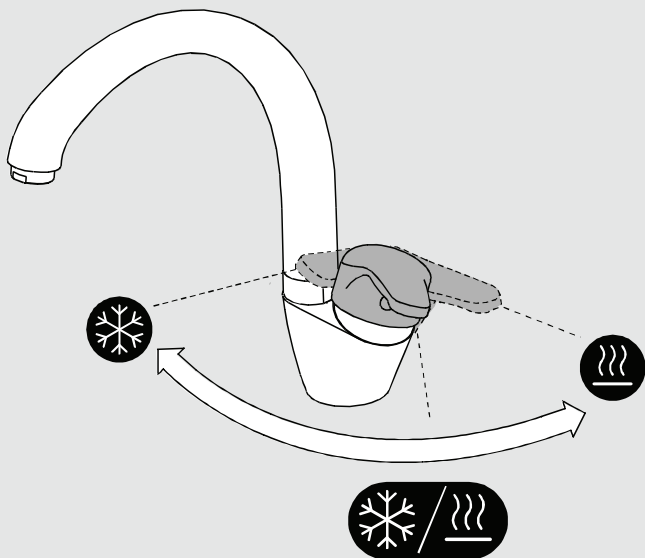



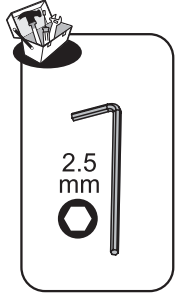

FR: Changement de cartouche/ ES: Cambio de cartucho/ IT: Cambio cartuccia/ PT: Mudança de cartucho/  
EL: Αλλαγή φουσιγγίου/ PL: Wymiana wkładu / RU: Смена картриджа/ KZ: Картриджді ауыстыру/  
UA: Заміна картриджа/ RO: Schimbare cartuş/ BR: Substituição de cartucho/ EN: Replacing the cartridge

1

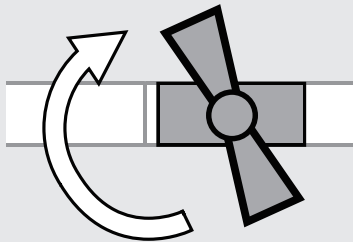

2

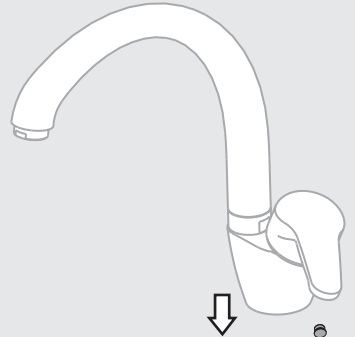

3

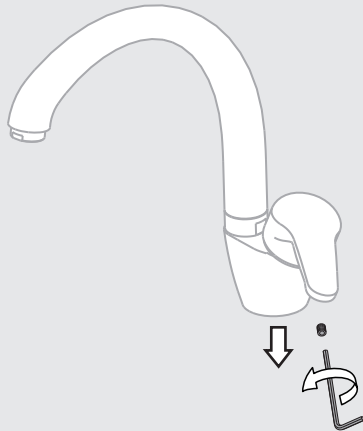

4

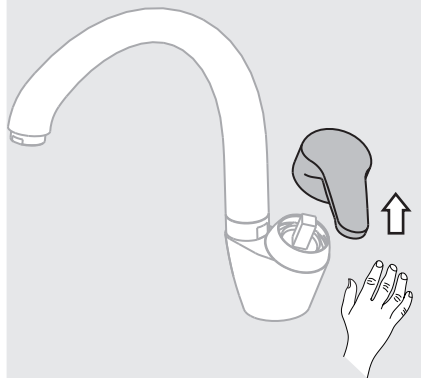

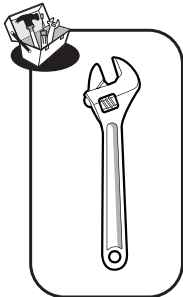

**FR:** Changement de cartouche/ **ES:** Cambio de cartucho/ **IT:** Cambio cartuccia/ **PT:** Mudança de cartucho/  
**EL:** Αλλαγή φουσιγγίου/ **PL:** Wymiana wkładu / **RU:** Смена картриджа/ **KZ:** Картриджді ауыстыру/  
**UA:** Заміна картриджа/ **RO:** Schimbare cartuş/ **BR:** Substituição de cartucho/ **EN:** Replacing the cartridge

5



6



7



8

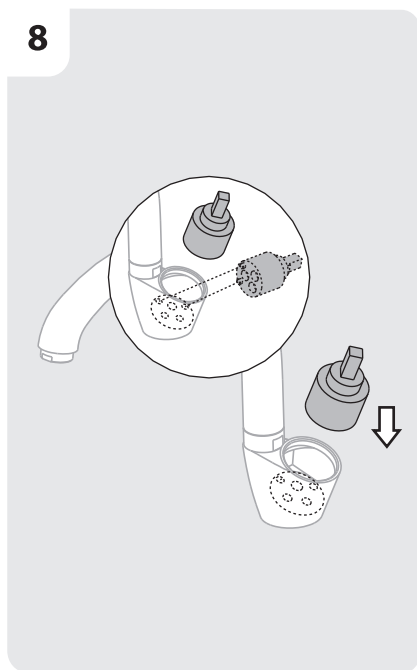

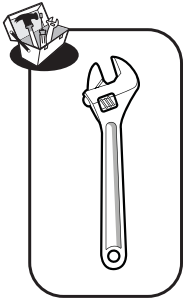

FR: Changement de cartouche/ ES: Cambio de cartucho/ IT: Cambio cartuccia/ PT: Mudança de cartucho/  
EL: Αλλαγή φουσιγγίου/ PL: Wymiana wkładu / RU: Смена картриджа/ KZ: Картриджді ауыстыру/  
UA: Заміна картриджа/ RO: Schimbare cartuş/ BR: Substituição de cartucho/ EN: Replacing the cartridge

9

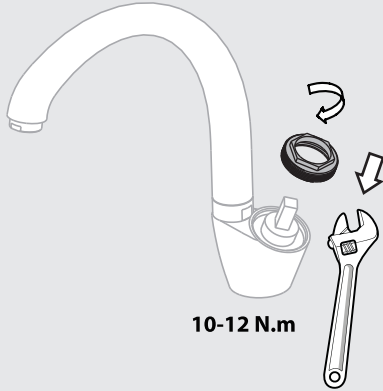

10-12 N.m

10

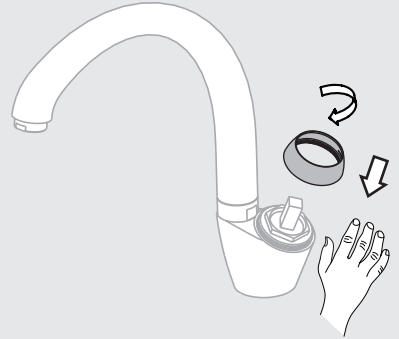

11

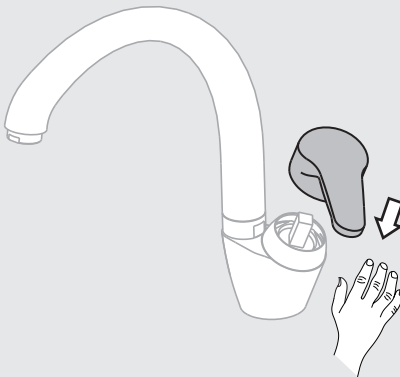

2.5  
mm

12

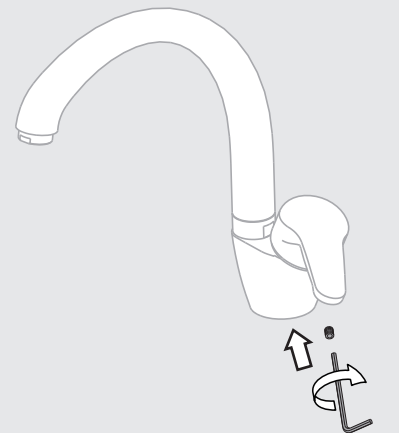



**FR:** Changement de cartouche/ **ES:** Cambio de cartucho/ **IT:** Cambio cartuccia/ **PT:** Mudança de cartucho/  
**EL:** Αλλαγή φουσιγγίου/ **PL:** Wymiana wkładu / **RU:** Смена картриджа/ **KZ:** Картриджді ауыстыру/  
**UA:** Заміна картриджа/ **RO:** Schimbare cartuş/ **BR:** Substituição de cartucho/ **EN:** Replacing the cartridge

13

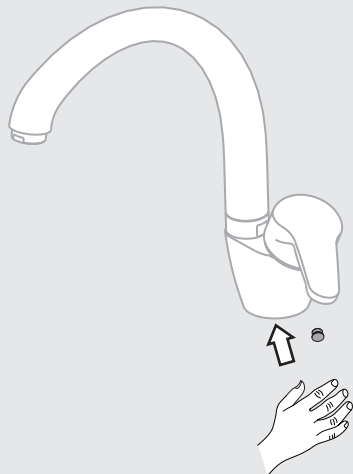

14



ON

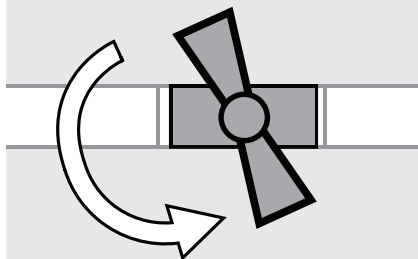

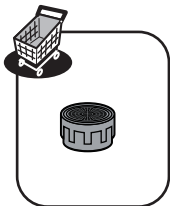

**FR:** Changement de mousseur/ **ES:** Cambio de aireador/ **PT:** Mudança de arejador/ **IT:** Cambio rompigetto/  
**EL:** Αλλαγή αεράτορα / **PL:** Wymiana perlatora / **RU:** Смена аэратора/ **KZ:** Ауақанықтырғышты ауыстыру/  
**UA:** Заміна аератора/ **RO:** Schimbare aerator/ **BR:** Substituição do aerador/ **EN:** Replacing the aerator

1

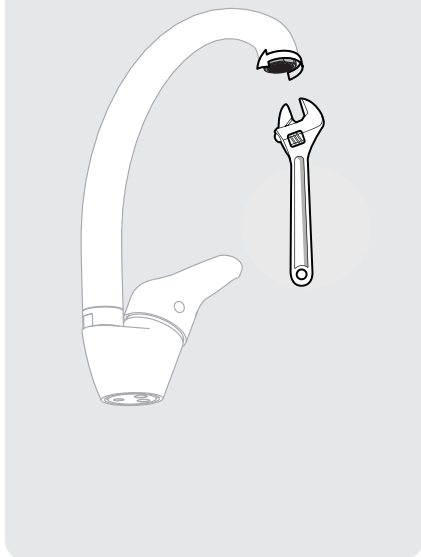

2



- |   |                     |                       |                    |
|---|---------------------|-----------------------|--------------------|
|  | <b>FR</b> Nettoyage | <b>EL</b> Καθαρισμός  | <b>UA</b> Очищення |
|   | <b>ES</b> Limpieza  | <b>PL</b> Czyszczenie | <b>RO</b> Curatare |
|   | <b>PT</b> Limpeza   | <b>RU</b> Чистка      | <b>BR</b> Limpeza  |
|   | <b>IT</b> Pulizia   | <b>KZ</b> тазарту     | <b>EN</b> Cleaning |

3

- |                    |                 |                    |                   |
|--------------------|-----------------|--------------------|-------------------|
| <b>FR</b> Vinaigre | <b>IT</b> Aceto | <b>RU</b> Уксус    | <b>RO</b> Oțet    |
| <b>ES</b> Vinagre  | <b>EL</b> Ξύδι  | <b>KZ</b> Сірке су | <b>BR</b> Vinagre |
| <b>PT</b> Vinagre  | <b>PL</b> Ocet  | <b>UA</b> Оцет     | <b>EN</b> Vinegar |

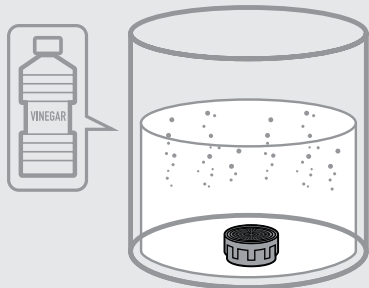

4

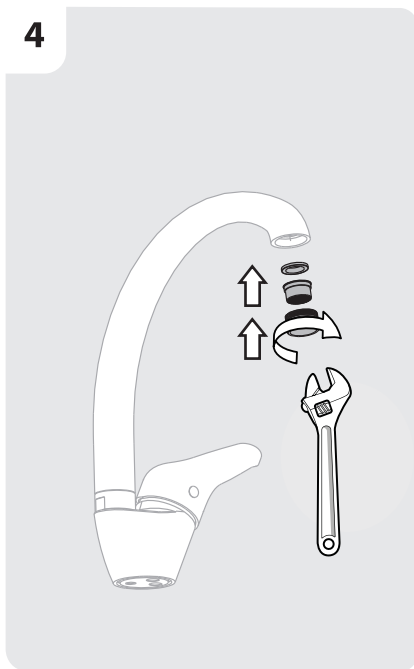

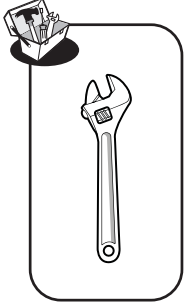

**FR:** Changement de flexibles/ **ES:** Cambio de flexibles / **PT:** Mudança de flexíveis/ **IT:** Cambio flessibili/  
**EL:** Αλλαγή λάστιχων/ **PL:** Wymiana wężyków instalacyjnych / **RU:** Смена гибкого шланга для смесителя/  
**UA:** Заміна гнучкого шланга для змішувача/ **KZ:** Қоспалауышқа арналған иілгіш шлангты ауыстыру/  
**RO:** Schimbare furtune flexibile/ **BR:** Substituição das mangueiras/ **EN:** Replacing the hoses

1

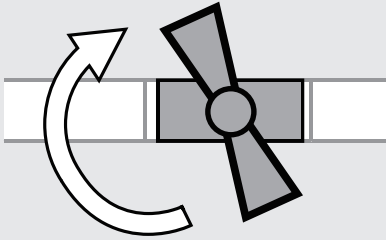

2

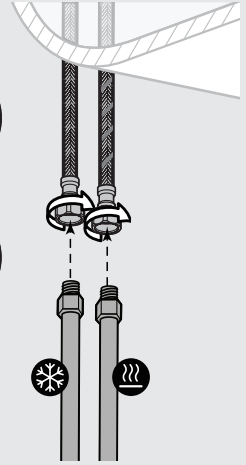

3



ON

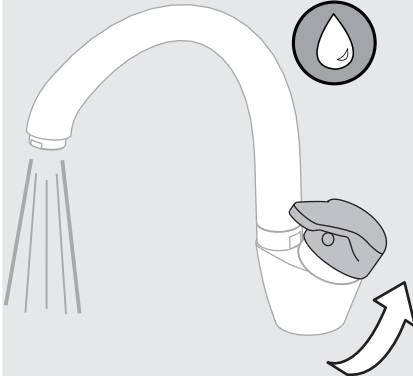

4

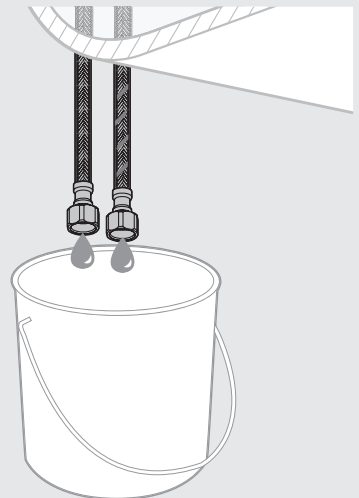

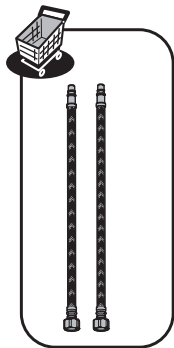

FR: Changement de flexibles/ ES: Cambio de flexibles/ PT: Mudança de flexíveis/ IT: Cambio flessibili/  
 EL: Αλλαγή λάστιχων/ PL: Wymiana wężyków instalacyjnych/ RU: Смена гибкого шланга для смесителя/  
 UA: Заміна гнучкого шланга для змішувача/ KZ: Қоспалауышқа арналған иілгіш шлангты ауыстыру/  
 RO: Schimbare furtune flexibile/ BR: Substituição das mangueiras/ EN: Replacing the hoses

5

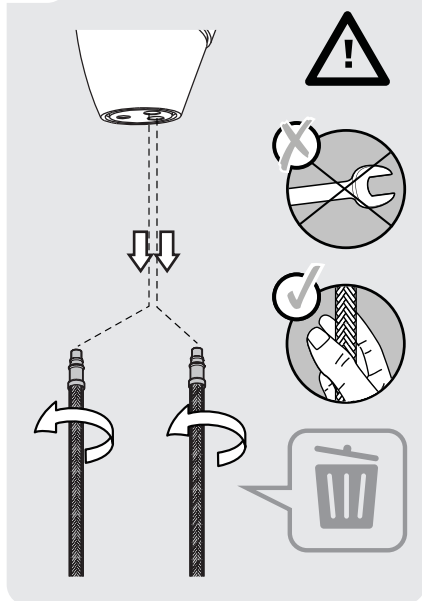

6

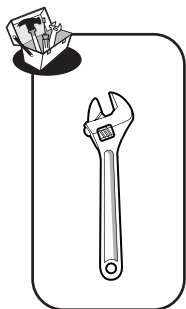
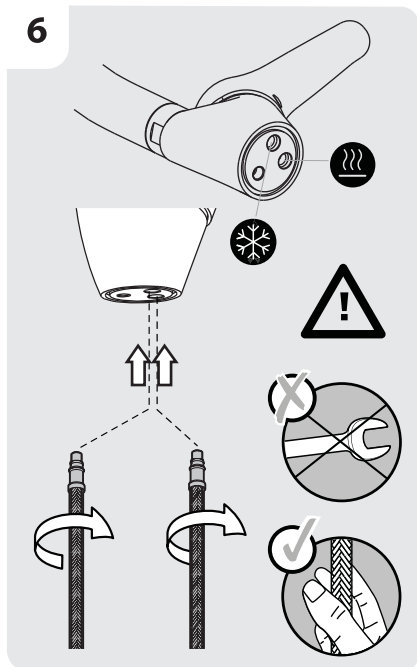

7

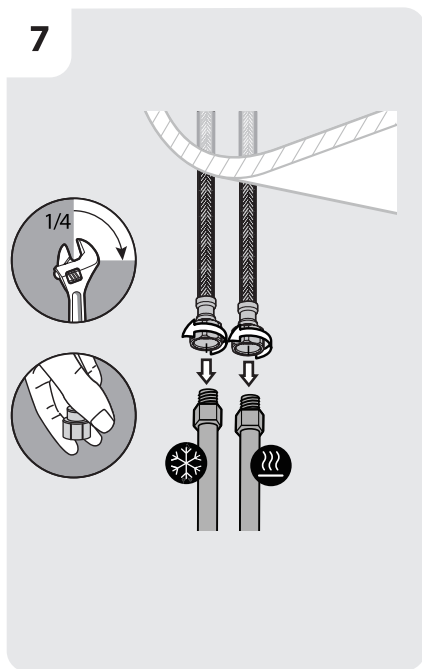

8

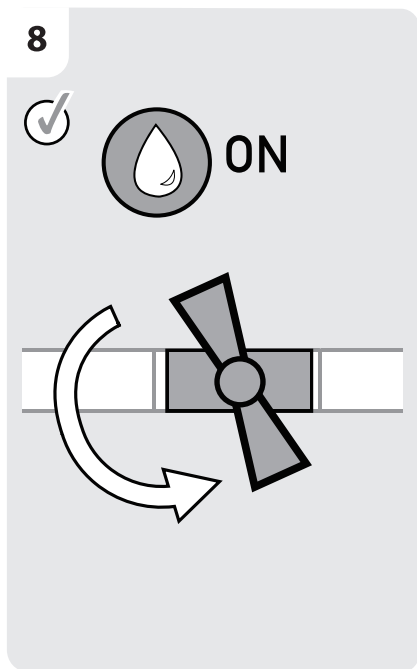



Eau claire / Agua limpia / Água limpa / Acqua pulita / Καθαρό νερό / Czysta woda / Чистая вода / Água limpa /  
Чиста вода / Ara curata / таза су / Clean water



Sans solvant / Sin disolvente / Sem solventes / Senza solventi / Χωρίς διαλυτικά / Bez rozpuszczalnika / Без растворителя /  
Sem solventes/ Без розчинника / Fara solvent / еріткішсіз/ Solvent-free

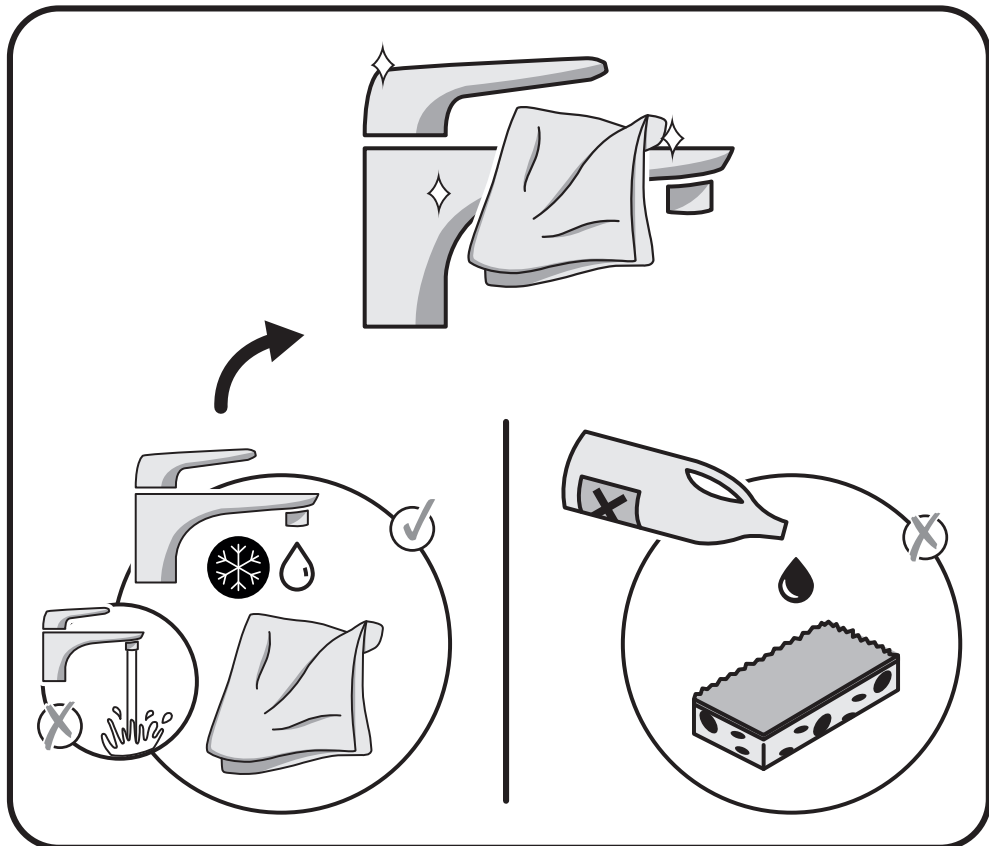



NO	DESCRIPTION	CODENO	QTY	REMARK
1	Handle	25	1	
2	Beautify Cover	603087 CR	1	
3	Pressing Nut	604118 BC	1	
4	Cartridge	SN-40 S/D THEDRA	1	
5	Mixer Body	9112-01	1	
6	Spout	9112-02	1	
7	Aerator	40.2104.000	1	
8	Aerator Shell	301001CR	1	
9	Oring	128	1	
10	Triangle base	47003.001BC	1	
11	Fixing pack	47004.001BC	1	
12	Inlet hose	TAQ-PEX-DN6-ACB H3/8-M8X1 L12-450	2	
13	Connector	T-198	2	

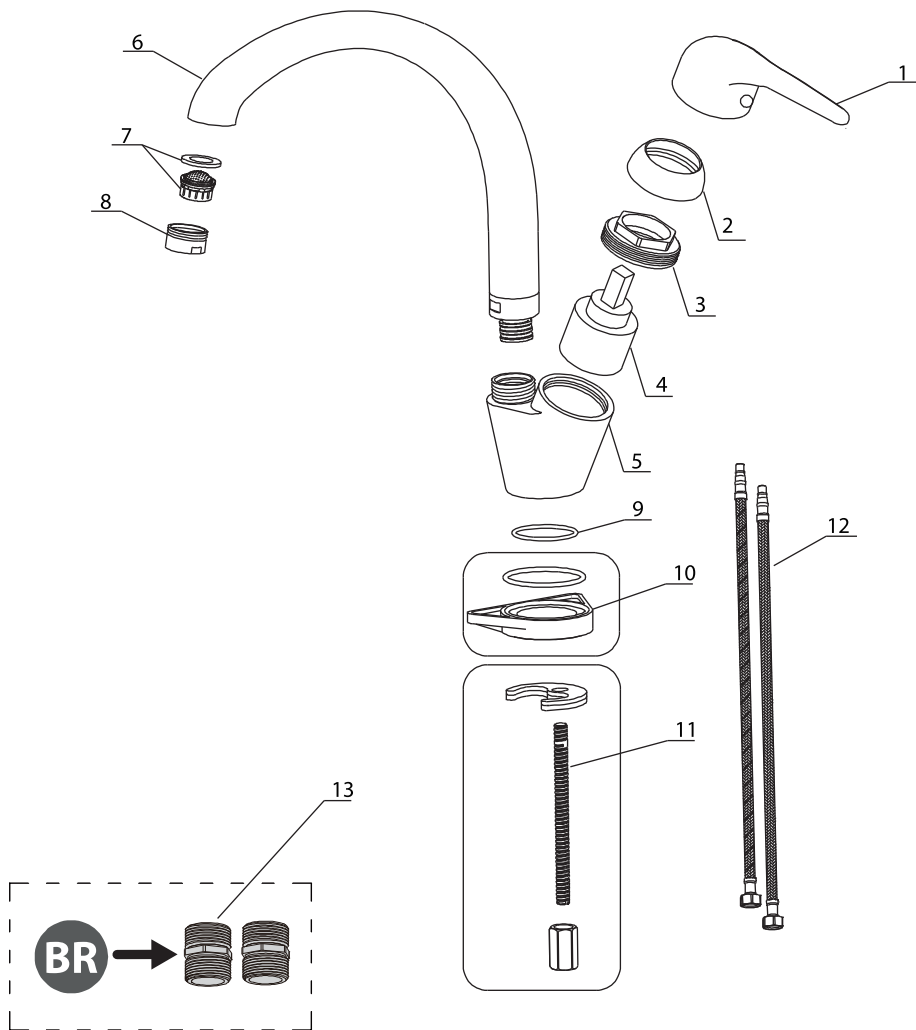







Certificado de conformidad sanitaria.  
Atestado de conformidade sanitária.  
certificato di conformità sanitaria.  
Βεβαίωση υγειονομικής συμμόρφωσης.  
Certyfikat zgodności sanitarnej.  
Декларация о соответствии санитарным нормам  
Санитарлық талаптарға сәйкестік декларациясы  
Декларация про відповідність санітарним нормам  
Atestat de conformitate sanitară  
Certificado de conformidade sanitária.  
Declaration of sanitary conformity.  
Attestation de conformité sanitaire

\* Garantie 10 ans / 10 años de garantía / Garantia de 10 anos / Garanzia 10 Anni / Εγγύηση 10 ετών / Gwarancja 10-letnia / Гарантия 10 года / Кепілдік 10 жыл / Гарантія 10 років /  
Garantje 10 ani / 10 anos de garantia / 10-year guarantee

Made in P.R.C 2018

ADEO Services - 135 Rue Sadi Carnot - CS 00001  
59790 RONCHIN - France

**UA** ТОВ «Леруа Мерлен Україна»,  
вул. Полярна 17а, м. Київ 04201, Україна

