

EAN CODE : 3276000596202
3276000597773
3276000597759

FR Manuel d'Instructions

ES Manual de Instrucciones

PT Manual de Instruções

IT Manuale di Istruzioni

EL Εγχειρίδιο Οδηγίων

PL Instrukcja Obsługi

RU Руководства по
Эксплуатации

KZ Пайдаланушы Нұсқаулығы

UA Інструкція з Експлуатації

RO Manual de Instrucțiuni

BR Manual de Instruções

EN Instructions Manual

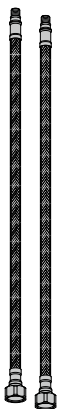
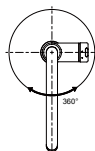
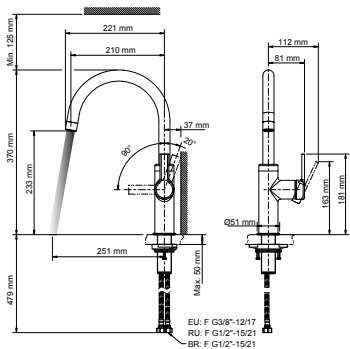

C

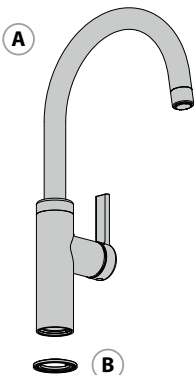

A

B

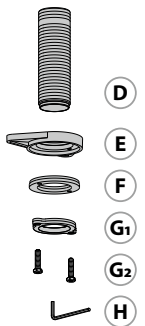



FR: Préparation / ES: Preparación / PT: Preparação / IT: Preparazione / EL: Προετοιμασία /
PL: Przygotowanie / RU: Подготовка / KZ: Дайындау / UA: Підготовка / RO: Pregătire / BR: Preparação /
EN: Preparation



FR: Montage / ES: Montaje / PT: Montagem / IT: Montaggio / EL: Συναρμολόγηση /
PL: Montaż / RU: Сборка / KZ: Монтаждау / UA: Збірка / RO: Montaj / BR: Montagem /
EN: Assembly



FR: Utilisation eau chaude-eau froide/ ES: Utilización agua caliente-agua fría/ PT: Utilização água quente-água fria/
IT: Uso acqua calda-acqua fredda/ EL: Χρήση ζεστού-κρύου νερού/ PL: Użytkowanie zimnej wody-gorącej wody/
RU: Використання гарячої води/ KZ: Суық және ыстық суды қолдану/ UA: води - холодної води/
RO: Utilizare apă caldă-apă rece/ BR: Uso de água quente e fria/ EN: Using hot and cold water



FR: Changement de cartouche/ ES: Cambio de cartucho/ PT: Mudança de cartucho/ IT: Cambio cartuccia/
EL: Αλλαγή φυσιγγίου/ PL: Wymiana wkładu/ RU: Смена картриджа/ KZ: Картриджі ауыстыру/
UA: Заміна картриджа/ RO: Schimbare cartuş/ BR: Substituição de cartucho/ EN: Replacing the cartridge



FR: Changement de mousseur/ ES: Cambio de aireador/ PT: Mudança de arejador/ IT: Cambio rompighetto/
EL: Αλλαγή αεράτορα/ PL: Wymiana perlatora/ RU: Смена аэратора/ KZ: Ауақанықтырғышты ауыстыру/
UA: Заміна аератора/ RO: Schimbare aerator/ BR: Substituição do aerador/ EN: Replacing the aerator



FR: Changement de flexibles/ ES: Cambio de flexibles / PT: Mudança de flexíveis/ IT: Cambio flessibili/
EL: Αλλαγή λάστιχων/ PL: Wymiana wężyków instalacyjnych / RU: Смена гибкого шланга для смесителя/
KZ: Қоспауышқа арналған иілгіш шлангты ауыстыру/ UA: Заміна гнучкого шланга для змішувача/
RO: Schimbare furtune flexibile/ BR: Substituição das mangueiras/ EN: Replacing the hoses

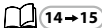



FR: Préparation / ES: Preparación / PT: Preparação / IT: Preparazione / EL: Προετοιμασία /
PL: Przygotowanie / RU: Подготовка / KZ: Дайындау / UA: Підготовка / RO: Pregătire /
BR: Preparação / EN: Preparation

1

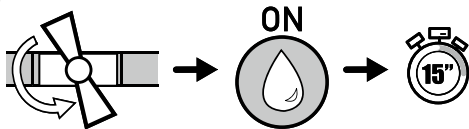

2

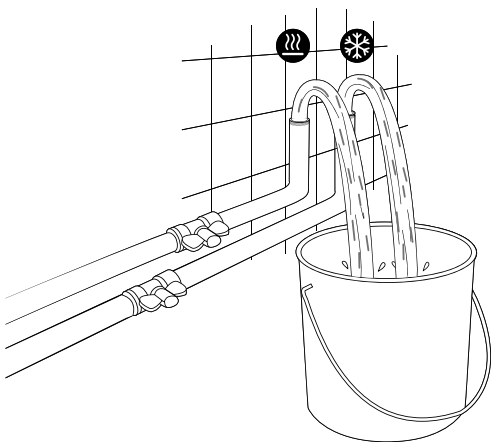

3

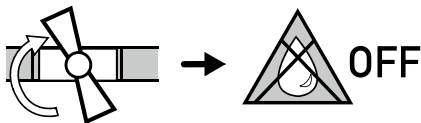

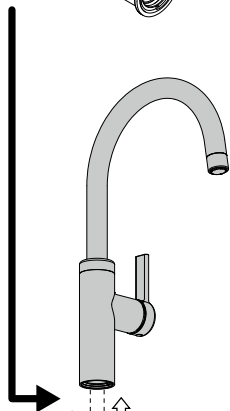
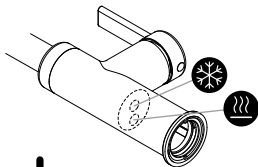
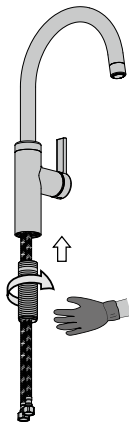
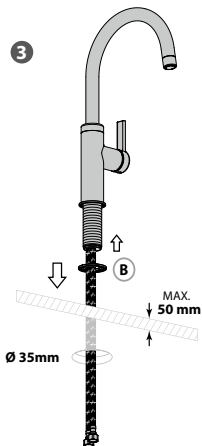

FR: Montage / ES: Montaje / PT: Montagem / IT: Montaggio / EL: Συναρμολόγηση /
 PL: Montaż / RU: Сборка / KZ: Монтаж / UA: Збірка / RO: Montaj / BR: Montagem /
 EN: Assembly

**B****C****D****1****1****D****C****2****3**

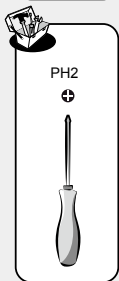
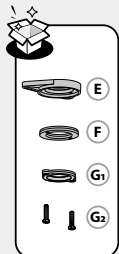

2



1

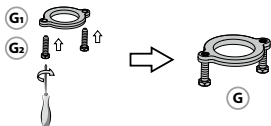

A

11 → 50
mm mm

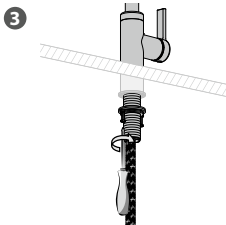
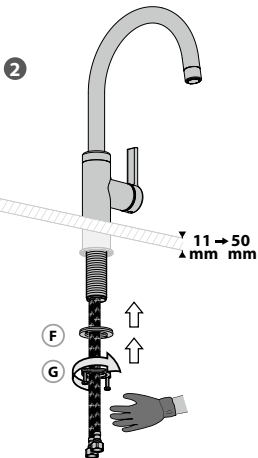

B

0,1 → 10
mm mm

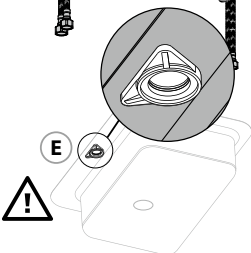
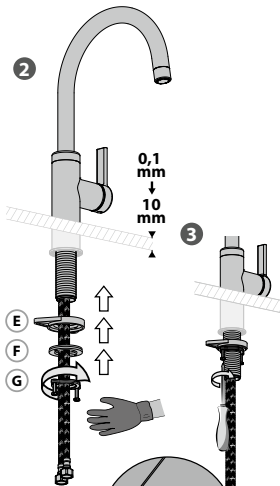

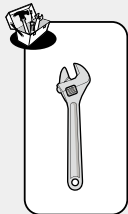

3

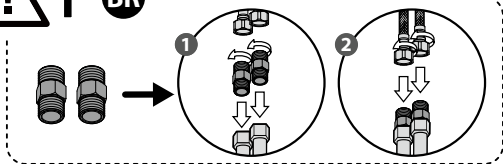
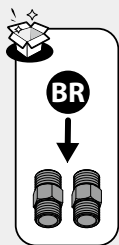
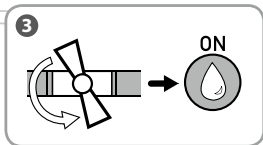
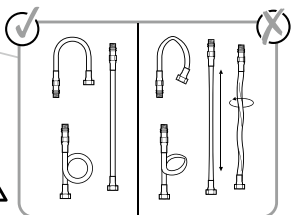
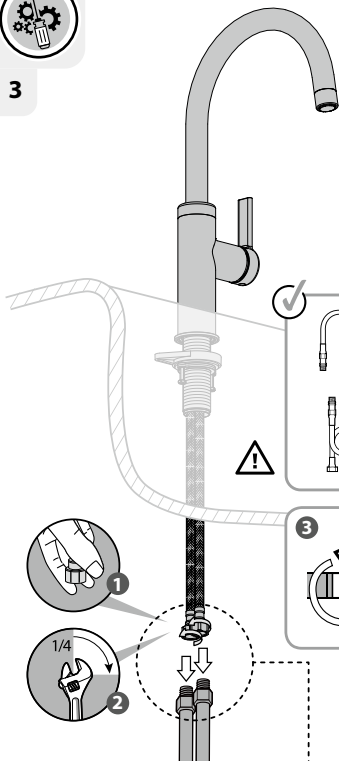



FR: Utilisation eau chaude-eau froide/ **ES:** Utilización agua caliente-agua fría/ **PT:** Utilização água quente-água fria/
IT: Uso acqua calda-acqua fredda/ **EL:** Χρήση ζεστού-κρύου νερού/ **PL:** Użytkowanie zimnej wody-gorącej wody/
RU: Використання гарячої води/ **KZ:** Суық және ыстық суды қолдану/ **UA:** води - холодної води/
RO: Utilizare apă caldă-apă rece/ **BR:** Uso de água quente e fria/ **EN:** Using hot and cold water

1

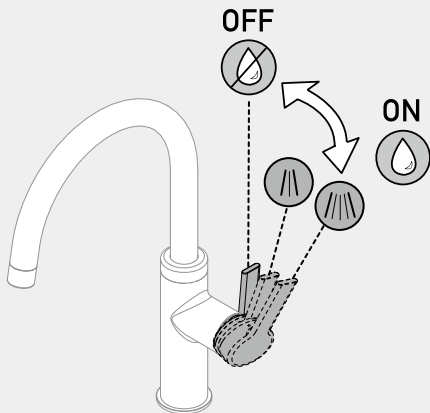

2

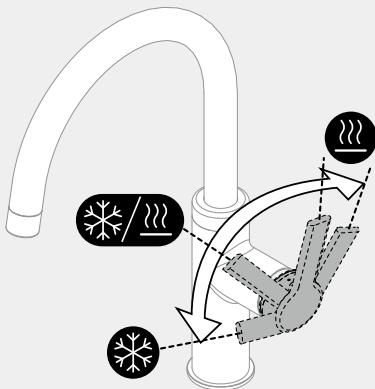



FR: Changement de cartouche/ ES: Cambio de cartucho/ PT: Mudança de cartucho/ IT: Cambio cartuccia/
EL: Αλλαγή φουσιγγίου/ PL: Wymiana wkładu/ RU: Смена картриджа/ KZ: Картриджді ауыстыру/
UA: Заміна картриджа/ RO: Schimbare cartus/ BR: Substituição de cartucho/ EN: Replacing the cartridge

1

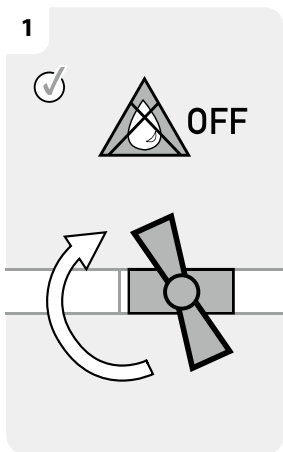

2

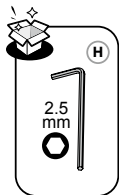
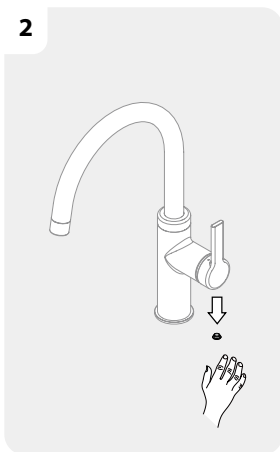

3

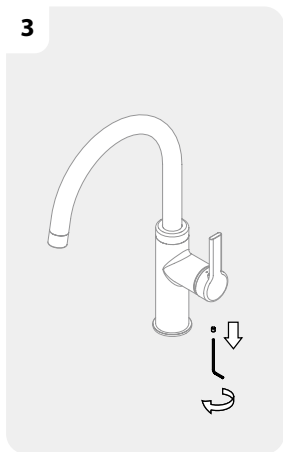

4



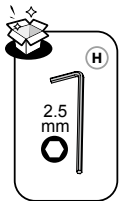

FR: Changement de cartouche/ ES: Cambio de cartucho/ PT: Mudança de cartucho/ IT: Cambio cartuccia/
EL: Αλλαγή φουσιγγίου/ PL: Wymiana wkładu/ RU: Смена картриджа/ KZ: Картриджи ауыстыру/
UA: Заміна картриджа/ RO: Schimbare cartus/ BR: Substituição de cartucho/ EN: Replacing the cartridge

5

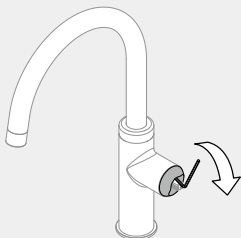

6

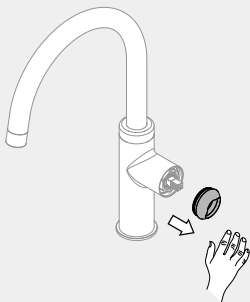

7

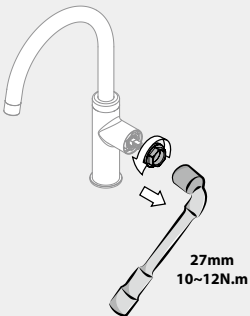

8

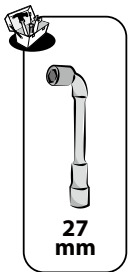

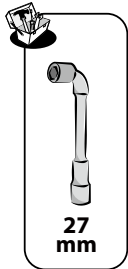

FR: Changement de cartouche/ ES: Cambio de cartucho/ PT: Mudança de cartucho/ IT: Cambio cartuccia/
EL: Αλλαγή φουγγιού/ PL: Wymiana wkładu/ RU: Смена картриджа/ KZ: Картриджи ауыстыру/
UA: Заміна картриджа/ RO: Schimbare cartus/ BR: Substituição de cartucho/ EN: Replacing the cartridge

9

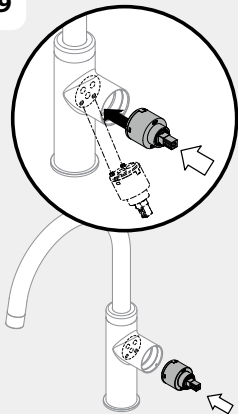

10

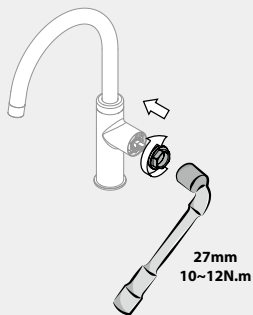

11



12



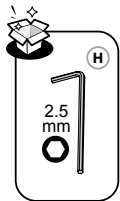

FR: Changement de cartouche/ **ES:** Cambio de cartucho/ **PT:** Mudança de cartucho/ **IT:** Cambio cartuccia/
EL: Αλλαγή φουσιγγίου/ **PL:** Wymiana wkładu/ **RU:** Смена картриджа/ **KZ:** Картриджді ауыстыру/
UA: Заміна картриджа/ **RO:** Schimbare cartus/ **BR:** Substituição de cartucho/ **EN:** Replacing the cartridge

13

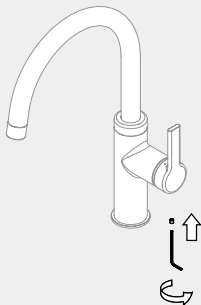

14

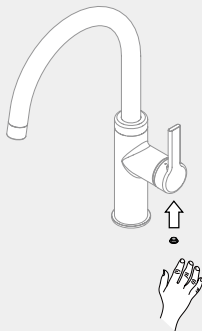

15

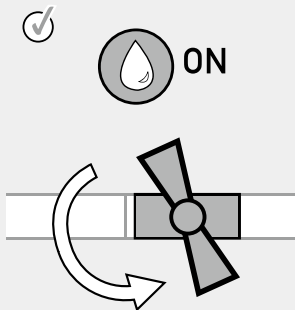



FR: Changement de mousseur/ ES: Cambio de aireador/ PT: Mudança de arejador/ IT: Cambio rompigoetto/
 EL: Αλλαγή αεράτορα/ PL: Wymiana perlatora/ RU: Смена аэратора/ KZ: Ауақанықтырғышты ауыстыру/
 UA: Заміна аератора/ RO: Schimbare aerator/ BR: Substituição do aerador/ EN: Replacing the aerator

1

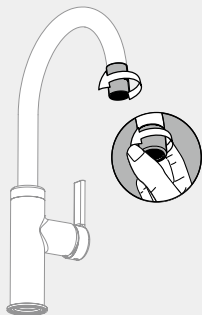

2



- | | | | |
|---|--------------|----------------|-------------|
|  | FR Nettoyage | EL Καθαρισμός | UA Очищення |
| | ES Limpieza | PL Czyszczenie | RO Curățare |
| | PT Limpeza | RU Чистка | BR Limpeza |
| | IT Pulizia | KZ тазарту | EN Cleaning |

3

- | | | | |
|-------------|----------|-------------|------------|
| FR Vinaigre | IT Aceto | RU Уксус | RO Oțet |
| ES Vinagre | EL Ξίδι | KZ Сірке су | BR Vinagre |
| PT Vinagre | PL Ocet | UA Оцет | EN Vinegar |

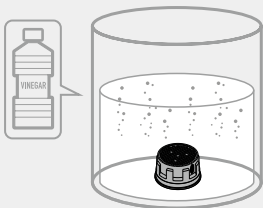

4

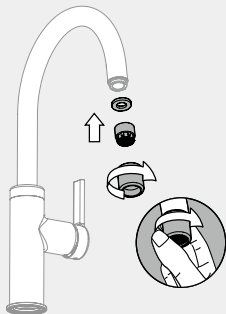

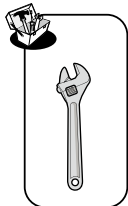

FR: Changement de flexibles/ ES: Cambio de flexibles/ PT: Mudança de flexíveis/ IT: Cambio flessibili/
EL: Αλλαγή λάστιχων/ PL: Wymiana wężyków instalacyjnych/ RU: Смена гибкого шланга для смесителя/
KZ: Қоспалауышқа арналған иілгіш шлангты ауыстыру/ UA: Заміна гнучкого шланга для змішувача/
RO: Schimbare furtune flexibile/ BR: Substituição das mangueiras/ EN: Replacing the hoses

1

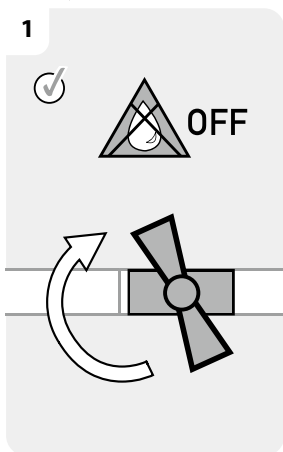

2

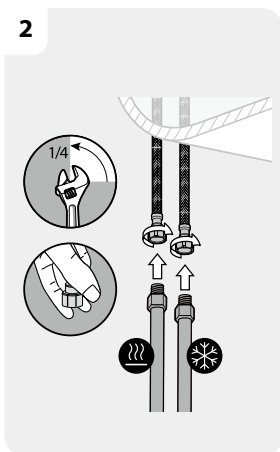

3

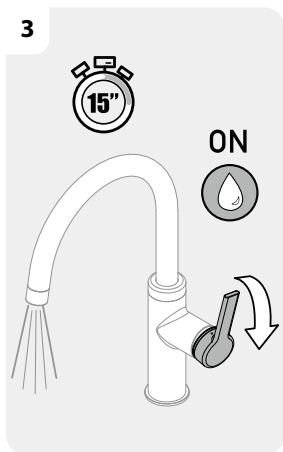

4

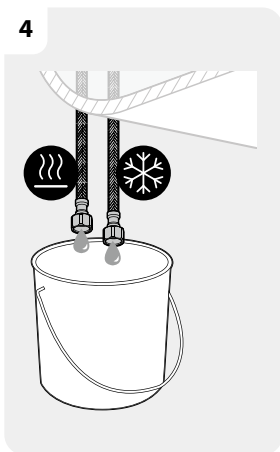

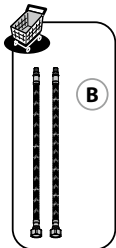

FR: Changement de flexibles/ ES: Cambio de flexibles / PT: Mudança de flexíveis/ IT: Cambio flessibili/
 EL: Αλλαγή λάστιχων/ PL: Wymiana wężyków instalacyjnych / RU: Смена гибкого шланга для смесителя/
 KZ: Қоспалауышқа арналған иілгіш шлангты ауыстыру/ UA: Заміна гнучкого шланга для змішувача/
 RO: Schimbare furtune flexibile/ BR: Substituição das mangueiras/ EN: Replacing the hoses

5

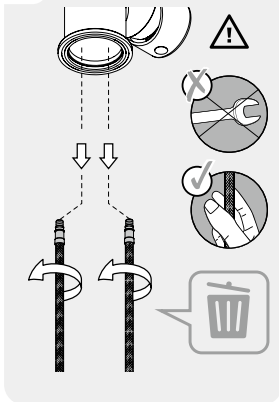

6

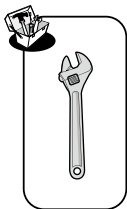
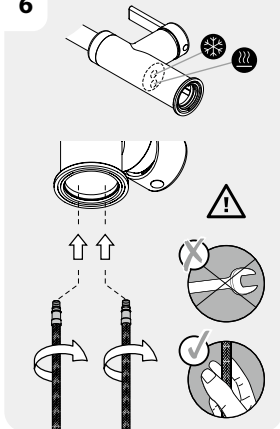

7

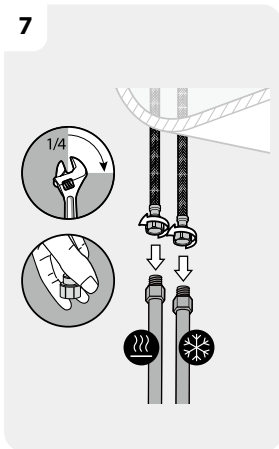

8

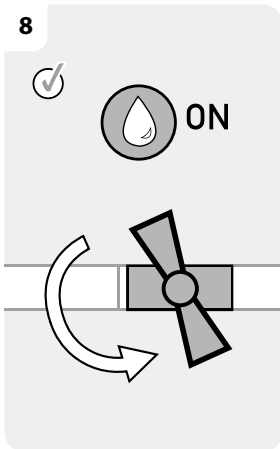



Eau claire / Agua limpia / Água limpa / Acqua pulita / Καθαρό νερό / Czysta woda / Чистая вода / Sem solventes /
Чиста вода / Apă curată / Agua limpa / Clean water



Sans solvant / Sin disolvente / Sem solventes / Senza solventi / Χωρίς διαλυτικά / Bez rozpuszczalnika / Без растворителя /
еріткішсіз / Без розчинника / Fără solvent / таза су / Solvent-free

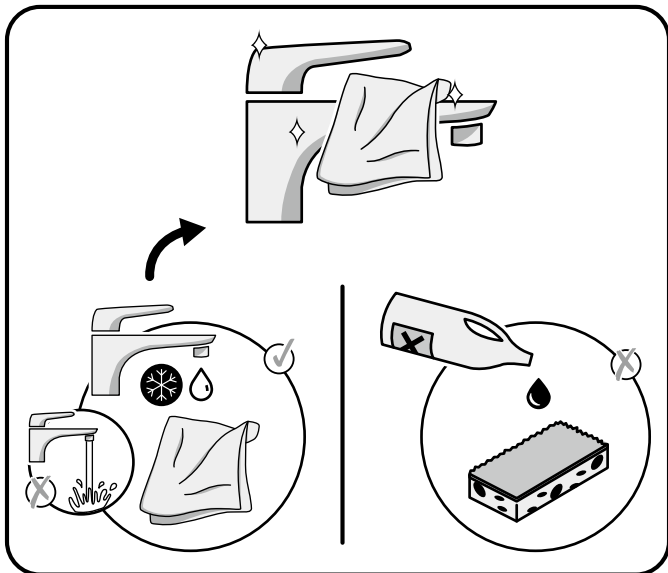

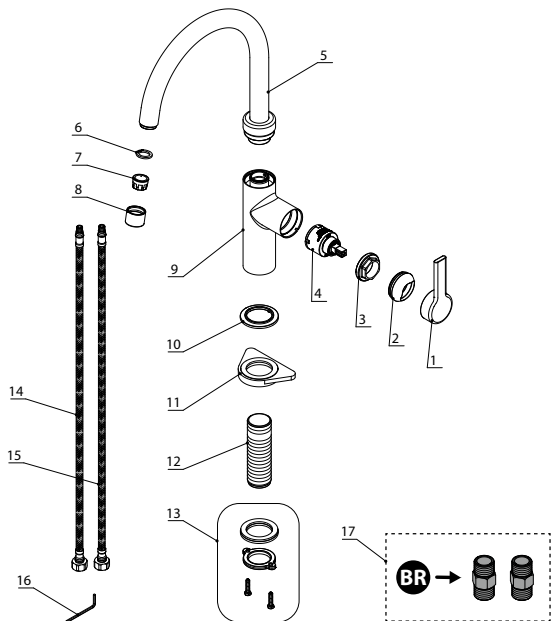

| NO. | Description | Code No. | QTY | Remark |
|-----|-------------------|--|-----|--------|
| 1 | Handle | A662A88 | 1 | |
| 2 | Beautifying cover | A663917 | 1 | |
| 3 | Compressing nut | A104372 | 1 | |
| 4 | Cartridge | EN35 SD COLD DUE MIRROR | 1 | |
| 5 | Spout | 523200-S-AX | 1 | |
| 6 | Seal | A010665N | 1 | |
| 7 | Aerator | 40.0003.000 | 1 | |
| 8 | Aerator housing | A305654-S | 1 | |
| 9 | Body assembly | 312020-50-T-AX | 1 | |
| 10 | Base ring | A66F607-Z | 1 | |
| 11 | Plastic triangle | A663B13 | 1 | |
| 12 | Easy fix shank | A228165 | 1 | |
| 13 | Fixing kit | A663B16 | 1 | |
| 14 | Inlet hose (H) | TAQ-PEX-DN6-ACB H3/8-M8x1 L12-550-R-QB | 1 | |
| 15 | Inlet hose (C) | TAQ-PEX-DN6-ACB H3/8-M8x1 L12-550-QB | 1 | |
| 16 | L-wrench | A031000 | 1 | |
| 17 | Connectors | A668322 | 1 | |



Certificado de conformidad sanitaria.
Atestado de conformidade sanitária.
certificato di conformità sanitaria.
Βεβαίωση υγειονομικής συμμόρφωσης.
Certyfikat zgodności sanitarnej.
Декларация о соответствии санитарным нормам
Санитарлық талаптарға сәйкестік декларациясы
Декларация про відповідність санітарним нормам
Atestat de conformitate sanitară
Certificado de conformidade sanitária.
Declaration of sanitary conformity.
Attestation de conformité sanitaire

* Garantie 10 ans / 10 años de garantía / Garantía de 10 años / Garanzia 10 Anni / Εγγύηση 10 ετών / Gwarancja 10-letnia / Гарантія 10 років / Кеніздік 10 жыл / Гарантія 10 років /
Garantje 10 ani / 10 anos de garantía / 10-year guarantee

Made in P.R.C. 2018

ADEO Services - 135 Rue Sadi Carnot - CS 00001
59790 RONCHIN - France



ТОВ «Леруа Мерлен Україна»,
вул. Полярна 17а, м. Київ 04201, Україна

