

delinia

Guarantee
10
years

SARA

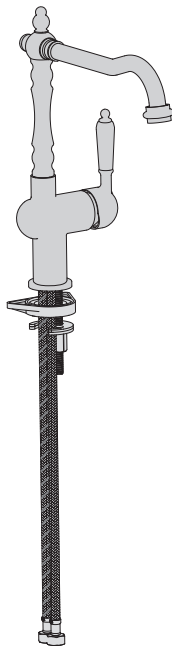

EAN CODE : 3276000592167
3276000592174
3276000592181
3276000596530
3276000596547
3276000632450
3276000632498

FR Manuel d'Instructions

ES Manual de Instrucciones

PT Manual de Instruções

IT Manuale di Istruzioni

EL Εγχειρίδιο Οδηγιών

PL Instrukcja Obsługi

RU Руководство по
Эксплуатации

KZ Пайдаланушы Нұсқаулығы

UA Інструкція з Експлуатації

RO Manual de Instrucțiuni

BR Manual de Instruções

EN Instructions Manual

2018/11/1402

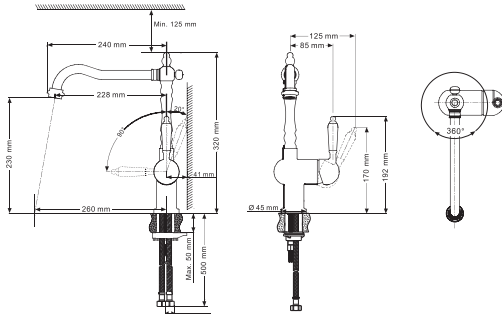

EU: F G 3/8" - 12/17
RU: F G 1/2" - 19/21
BR: F G 1/2" - 19/21

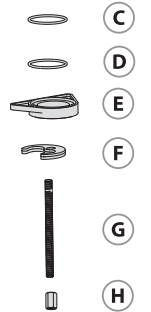
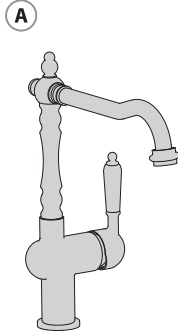



FR: Préparation / ES: Preparación / PT: Preparação / IT: Preparazione / EL: Προετοιμασία /
PL: Przygotowanie / RU: Подготовка / KZ: Дайындау / UA: Підготування / RO: Pregătire / BR: Preparação /
EN: Preparation



FR: Montage / ES: Montaje / PT: Montagem / IT: Montaggio / EL: Συναρμολόγηση /
PL: Montaż / RU: Сборка / KZ: Монтаждау / RO: Montaj / BR: Montagem /
EN: Assembly



FR: Utilisation eau chaude-eau froide/ ES: Utilización agua caliente-agua fría/ PT: Utilização água quente-água fria/
IT: Uso acqua calda-acqua fredda/ EL: Χρήση ζεστού-κρύου νερού/ PL: Użytkowanie zimnej wody-gorącej wody/
RU: Использование горячей и холодной воды/ UA: використання гарячої - холодної води/
RO: Utilizare apă caldă-apă rece/ EN: Using hot and cold water



FR: Changement de cartouche/ ES: Cambio de cartucho/ IT: Cambio cartuccia/ PT: Mudança de cartucho/
EL: Αλλαγή φουγγιγίου/ PL: Wymiana wkładu / RU: Замена картриджа/ KZ: Картриджді ауыстыру/
UA: заміна картриджа/ RO: Schimbare cartuş/ BR: Substituição de cartucho/ EN: Replacing the cartridge



FR: Changement de moussEUR/ ES: Cambio de aireador/ PT: Mudança de arejador/ IT: Cambio rompigetto/
EL: Αλλαγή αεράτορα / PL: Wymiana perlatora / RU: Замена аэратора/ KZ: Ауақанықтырғышты ауыстыру/
UA: заміна аератора/ RO: Schimbare aerator/ BR: Substituição do aerador/ EN: Replacing the aerator



FR: Changement de flexibles/ ES: Cambio de flexibles / PT: Mudança de flexíveis/ IT: Cambio flessibili/
EL: Αλλαγή λάστιχων/ PL: Wymiana wężyków instalacyjnych / RU: Замена гибкого шланга для смесителя/
UA: заміна гнучкого шланга для змішувача/ KZ: Қоспалауышқа арналған иілгіш шлангты ауыстыру/
RO: Schimbare furtune flexibile/ BR: Substituição das mangueiras/ EN: Replacing the hoses





FR: Préparation / ES: Preparación / PT: Preparação / IT: Preparazione / EL: Προετοιμασία /
PL: Przygotowanie / RU: Подготовка / KZ: Дайындау / UA: Підготовка / RO: Pregătire /
BR: Preparação / EN: Preparation

1

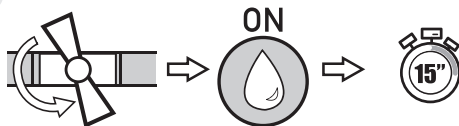

2

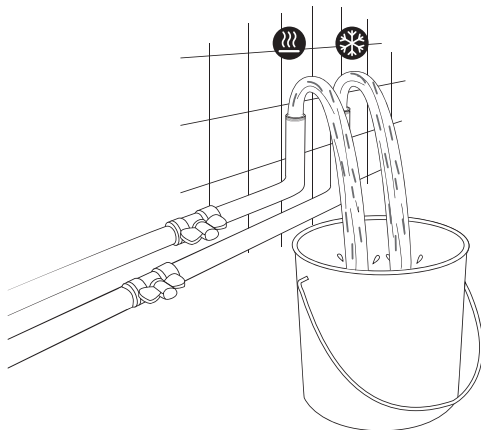

3

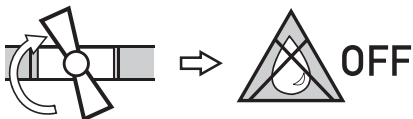

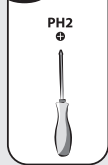
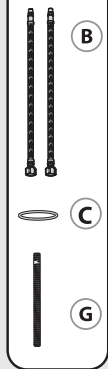

FR: Montage / ES: Montaje / PT: Montagem / IT: Montaggio / EL: Συναρμολόγηση /
PL: Montaż / RU: Сборка / KZ: Монтаждау / UA: Збірка / RO: Montaj / BR: Montagem /
EN: Assembly

1

1

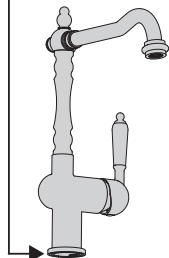
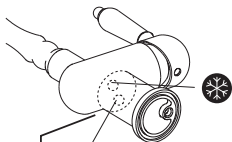

B

2

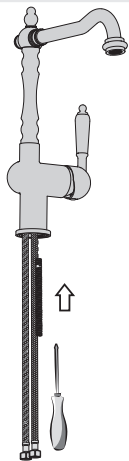

G

3

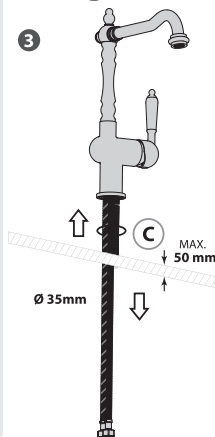

MAX.
50 mm

Ø 35mm



D

E

F

H

2



A

11 → 50
mm mm



B

0,1 → 10
mm mm



11mm

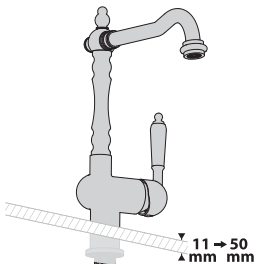

F



H

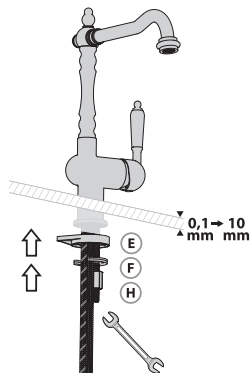

E

F

H

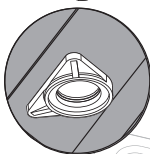

E



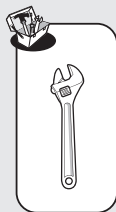

3

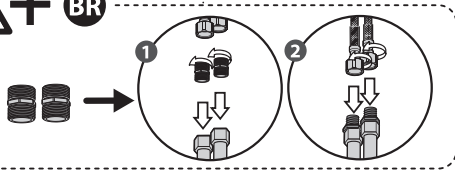
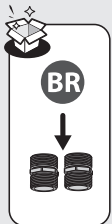
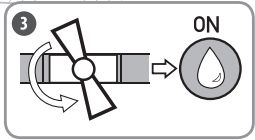
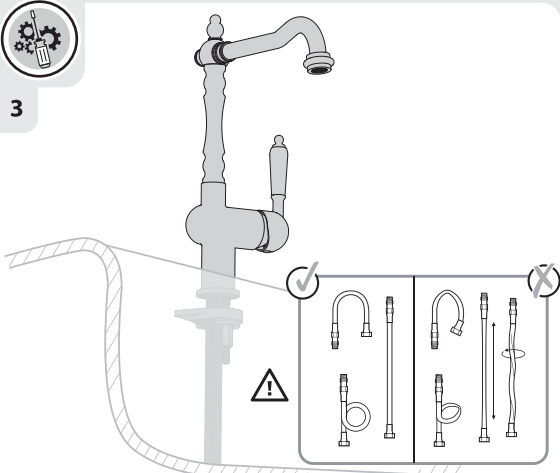



FR: Utilisation eau chaude-eau froide/ ES: Utilización agua caliente-agua fría/ PT: Utilização água quente-água fria/
IT: Uso acqua calda-acqua fredda/ EL: Χρήση ζεστού-κρύου νερού/ PL: Użytkowanie zimnej wody-gorącej wody/
RU: Использование горячей и холодной воды/ KZ: Суық және ыстық суды қолдану/
UA: використання гарьчої - холодної води/ RO: Utilizare apă caldă-apă rece/ BR: Uso de água quente e fria/
EN: Using hot and cold water

1

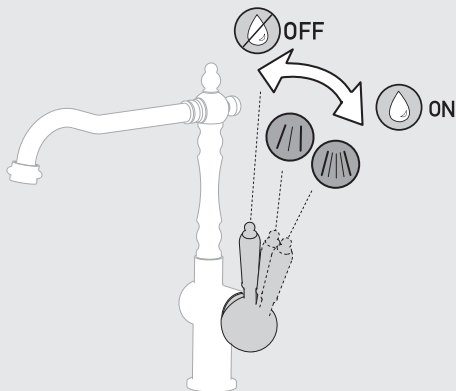
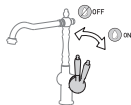

2

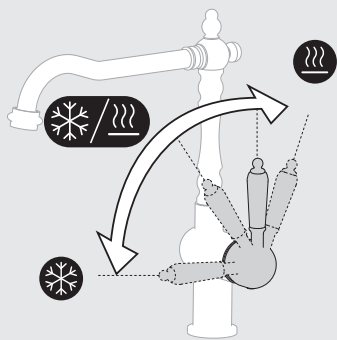

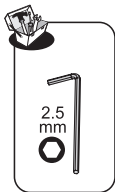

FR: Changement de cartouche/ ES: Cambio de cartucho/ IT: Cambio cartuccia/ PT: Mudança de cartucho/
EL: Αλλαγή φουσιγγίου/ PL: Wymiana wkładu / RU: Смена картриджа/ KZ: Картриджи ауыстыру/
UA: Заміна картриджа/ RO: Schimbare cartus/ BR: Substituição de cartucho/ EN: Replacing the cartridge

1



OFF

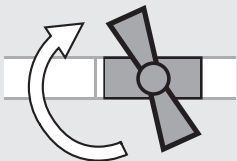

2

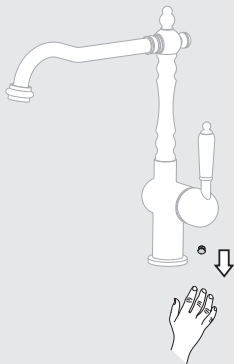

3

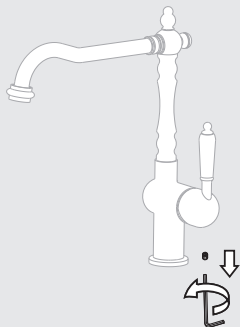

4

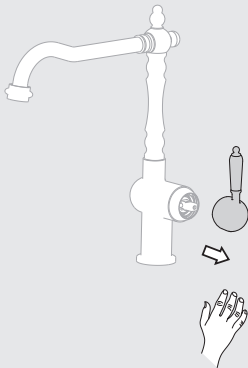

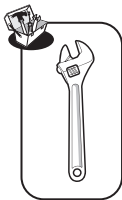

FR: Changement de cartouche/ ES: Cambio de cartucho/ IT: Cambio cartuccia/ PT: Mudança de cartucho/
EL: Αλλαγή φιοσίγγιου/ PL: Wymiana wkładu / RU: Смена картриджа/ KZ: Картриджді аумстыру/
UA: Заміна картриджа/ RO: Schimbare cartus/ BR: Substituição de cartucho/ EN: Replacing the cartridge

5

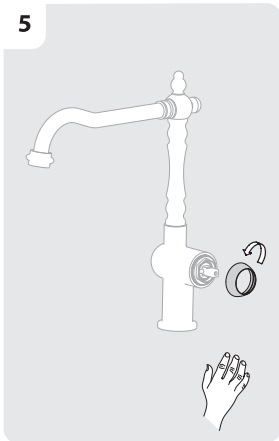

6

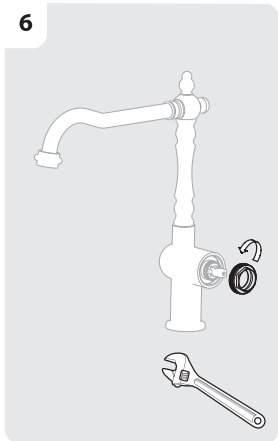

7



8

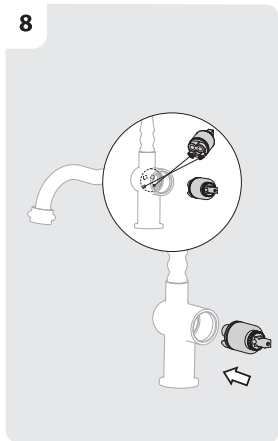

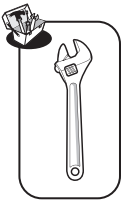

FR: Changement de cartouche/ ES: Cambio de cartucho/ IT: Cambio cartuccia/ PT: Mudança de cartucho/
EL: Αλλαγή φιαγγίου/ PL: Wymiana wkładu/ RU: Смена картриджа/ KZ: Картриджи ауыстыру/
UA: Заміна картриджа/ RO: Schimbare cartuş/ BR: Substituição de cartucho/ EN: Replacing the cartridge

9

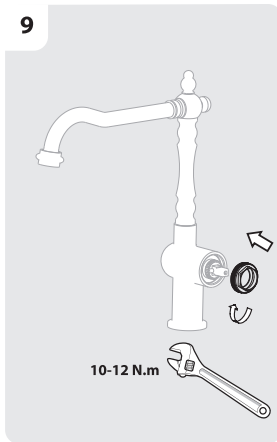

10

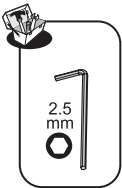
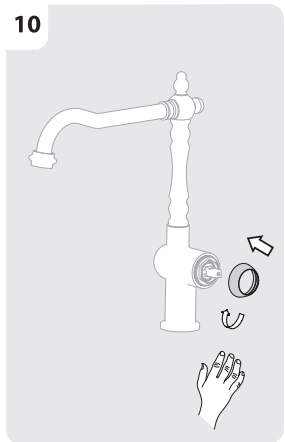

2.5
mm

11

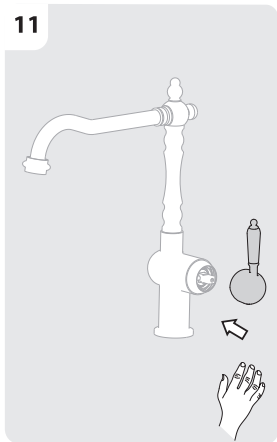

12

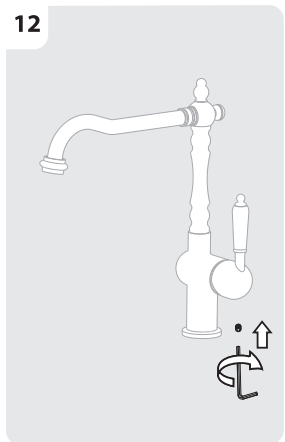



FR: Changement de cartouche/ ES: Cambio de cartucho/ IT: Cambio cartuccia/ PT: Mudança de cartucho/
EL: Αλλαγή φιογγίου/ PL: Wymiana wkładu / RU: смена картриджа/ KZ: Картриджи ауыстыру/
UA: Заміна картриджа/ RO: Schimbare cartus/ BR: Substituição de cartucho/ EN: Replacing the cartridge

13

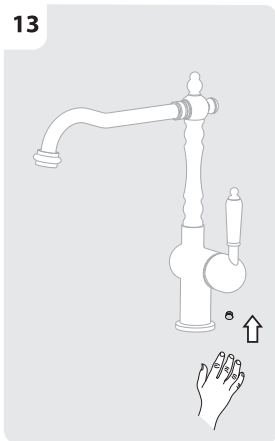

14

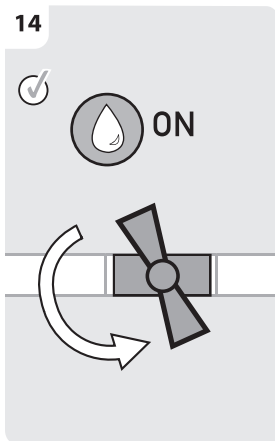

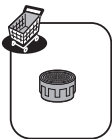

FR: Changement de mousseur/ ES: Cambio de aireador/ PT: Mudança de arejador/ IT: Cambio rompigetto/
 EL: Αλλαγή αεράτορα / PL: Wymiana perlatora / RU: Смена аэратора/ KZ: Ауақанықтырғышты ауыстыру/
 UA: Заміна аератора/ RO: Schimbare aerator/ BR: Substituição do aerador/ EN: Replacing the aerator

1

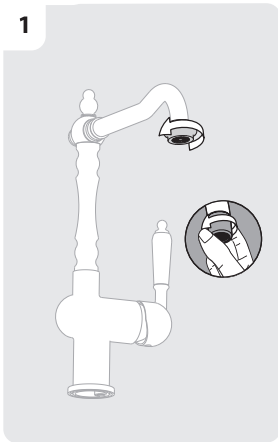

2

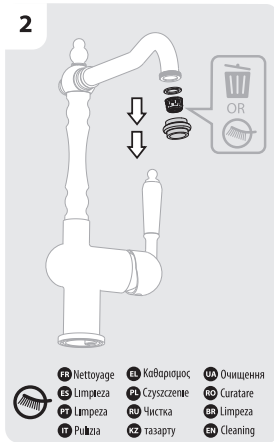

- | | | | | | |
|--------------|----------------|------------|------------|---------------|-------------|
| FR Nettoyage | ES Limpieza | PT Limpeza | IT Pulizia | EL Καθαρισμός | UA Очищення |
| ES Limpieza | PL Czyszczenie | RU Чистка | RU Чистка | RO Curățare | BR Limpeza |
| PT Limpeza | RU Чистка | RU Чистка | RU Чистка | BR Limpeza | EN Cleaning |

3

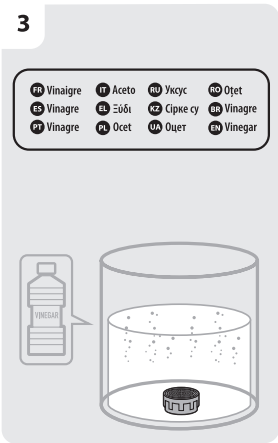

- | | | | |
|--------------|----------|-------------|------------|
| FR Vinaigre | IT Aceto | RU Уксус | RO Oțet |
| ES Vinagre | EL Ξίδι | KZ Сірке су | BR Vinagre |
| PL Winograce | PL Ocet | UA Оцет | EN Vinegar |

4

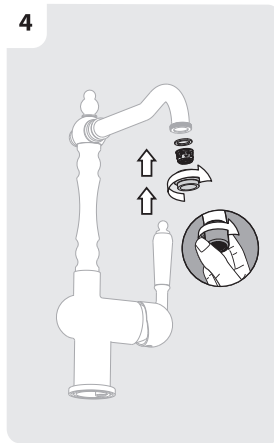

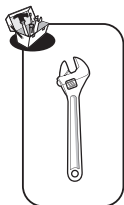

FR: Changement de flexibles/ ES: Cambio de flexibles/ PT: Mudança de flexíveis/ IT: Cambio flessibili/
EL: Αλλαγή λάστιχων/ PL: Wymiana wężyków instalacyjnych/ RU: Смена гибкого шланга для смесителя/
UA: Заміна гнучкого шланга для змішувача/ KZ: Қоспауышқа арналған иілгіш шлангты ауыстыру/
RO: Schimbare furtune flexibile/ BR: Substituição das mangueiras/ EN: Replacing the hoses

1

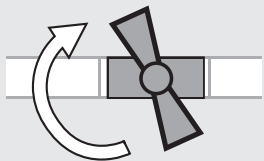

2

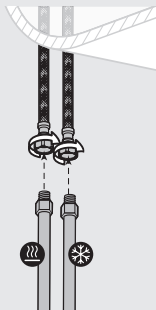

3



ON

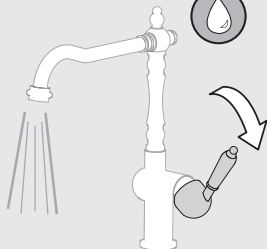

4

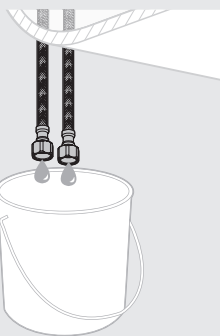



FR: Changement de flexibles/ ES: Cambio de flexibles / PT: Mudança de flexíveis/ IT: Cambio flessibili/
EL: Αλλαγή λάστιχων/ PL: Wymiana wężyków instalacyjnych / RU: Смена гибкого шланга для смесителя/
UA: Заміна гнучкого шланга для змішувача/ KZ: Қоспалауышқа арналған иілгіш шлангты ауыстыру/
RO: Schimbare furtune flexibile/ BR: Substituição das mangueiras/ EN: Replacing the hoses

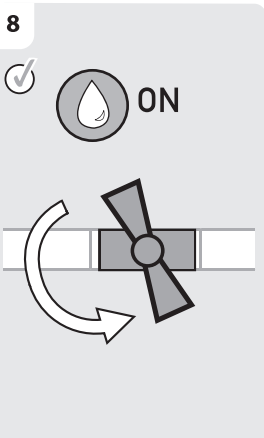
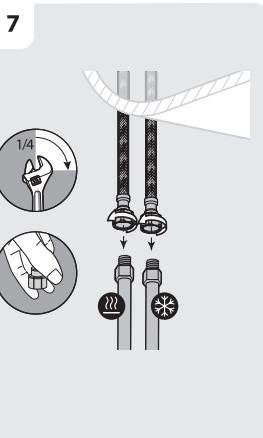
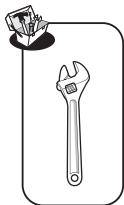
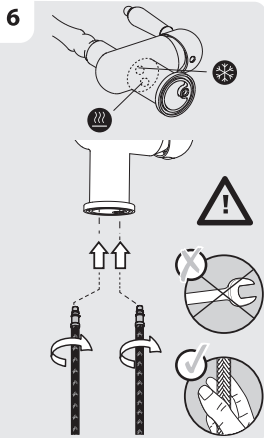
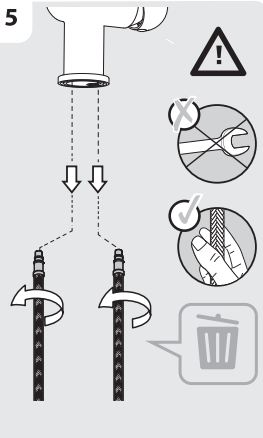



Eau claire / Agua limpia / Água limpa / Acqua pulita / Καθαρό νερό / Czysta woda / Чистая вода / Água limpa /
Чиста вода / Apa curata / таза су / Clean water



Sans solvant / Sin disolvente / Sem solventes / Senza solventi / Χωρίς διαλυτικά / Bez rozpuszczalnika / Без растворителя /
Sem solventes / Без розчинника / Fara solvent / еріткучіс / Solvent-free

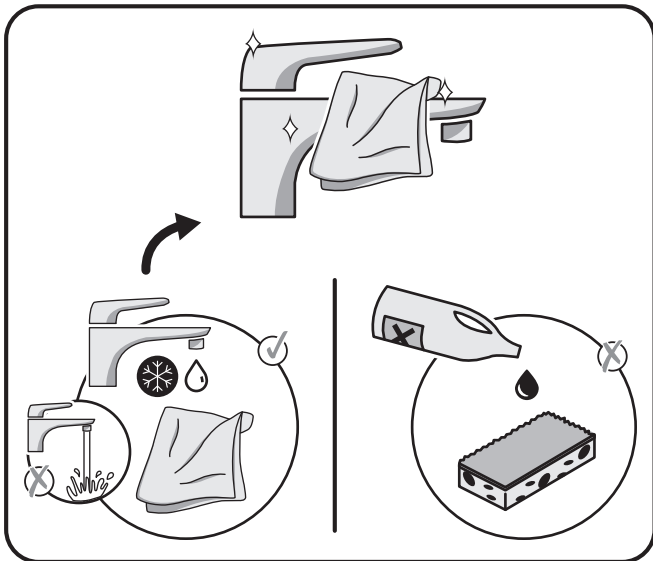

NO	DESCRIPTION	CODE NO	QTY	REMARK
1	Handle	92222CR	1	barcode:3276000592167 / 3276000596530 / 3276000632450
		92222BB		barcode:3276000592174 / 3276000632498
		92222MB		barcode:3276000592181 / 3276000596547
2	Beauty Cover	6030B7 CR	1	barcode:3276000592167 / 3276000596530 / 3276000632450
		6030B8 BB		barcode:3276000592174 / 3276000632498
		6030B8 MB		barcode:3276000592181 / 3276000596547
3	Pressing Nut	604118 BC	1	
4	Cartridge	EC40 CD COLD DUE MIRROR	1	
5	Mixer Body	109120 CR	1	3276000592167 / 3276000596530 / 3276000632450
		109120 BB		3276000592174 / 3276000632498
		109120 MB		3276000592181 / 3276000596547
6	Spout	92201CR	1	3276000592167 / 3276000596530 / 3276000632450
		92201BB		3276000592174 / 3276000632498
		92201MB		3276000592181 / 3276000596547
7	Aerator	601004.000	1	
8	Aerator Shell	301020 CR	1	3276000592167 / 3276000596530 / 3276000632450
		301020 BB		3276000592174 / 3276000632498
		301020 MB		3276000592181 / 3276000596547
9	O ring	126	1	
10	Triangle base	47003.001BC	1	
11	Fixing pack	47004.001BC	1	
12	Inlet hose	TA62-PEX-CN6-AC.B H3-8-MBX1 L1.3-350	2	3276000592167 / 3276000592174 / 3276000592181
		TA62-PEX-CN6-AC.B H1.2-MBX1 L1.3-350		3276000596530 / 3276000632450 / 3276000632498 / 3276000596547
13	Connector	T-198	2	

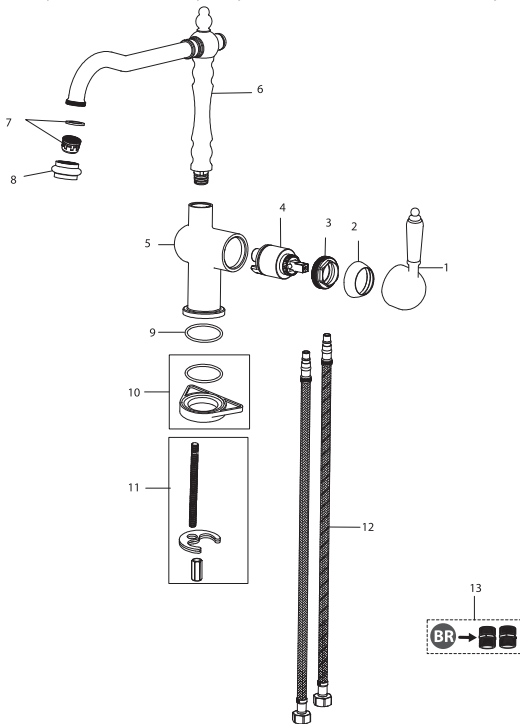

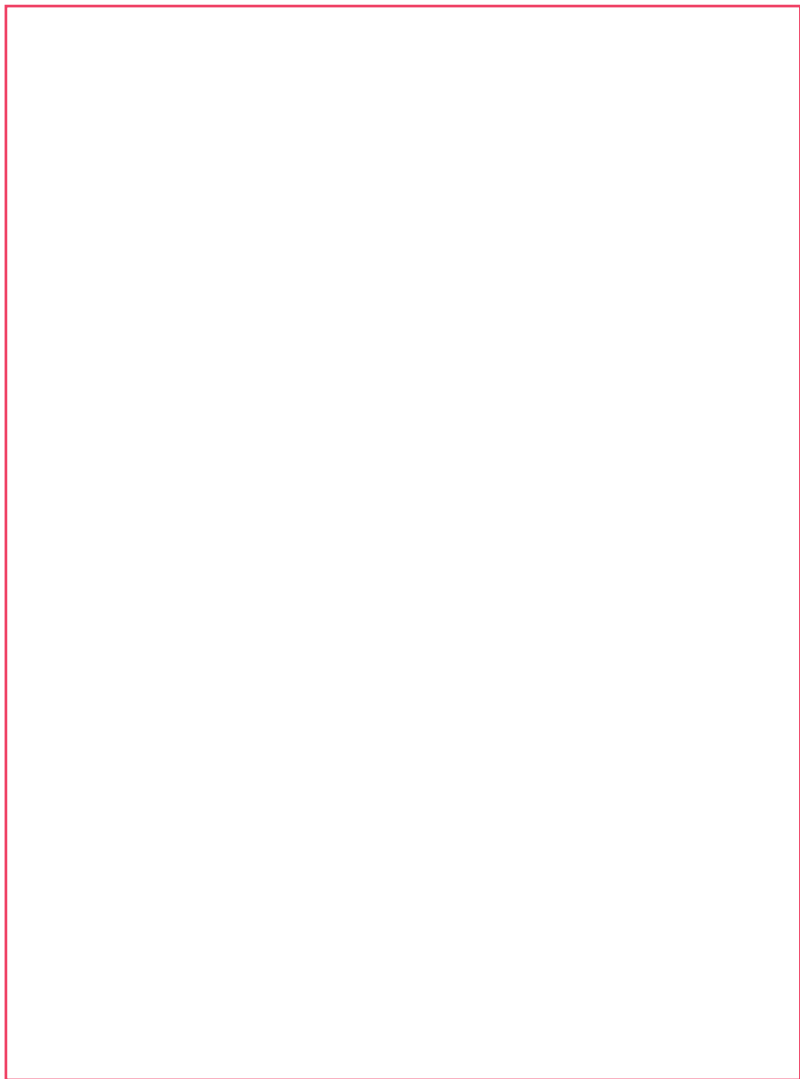

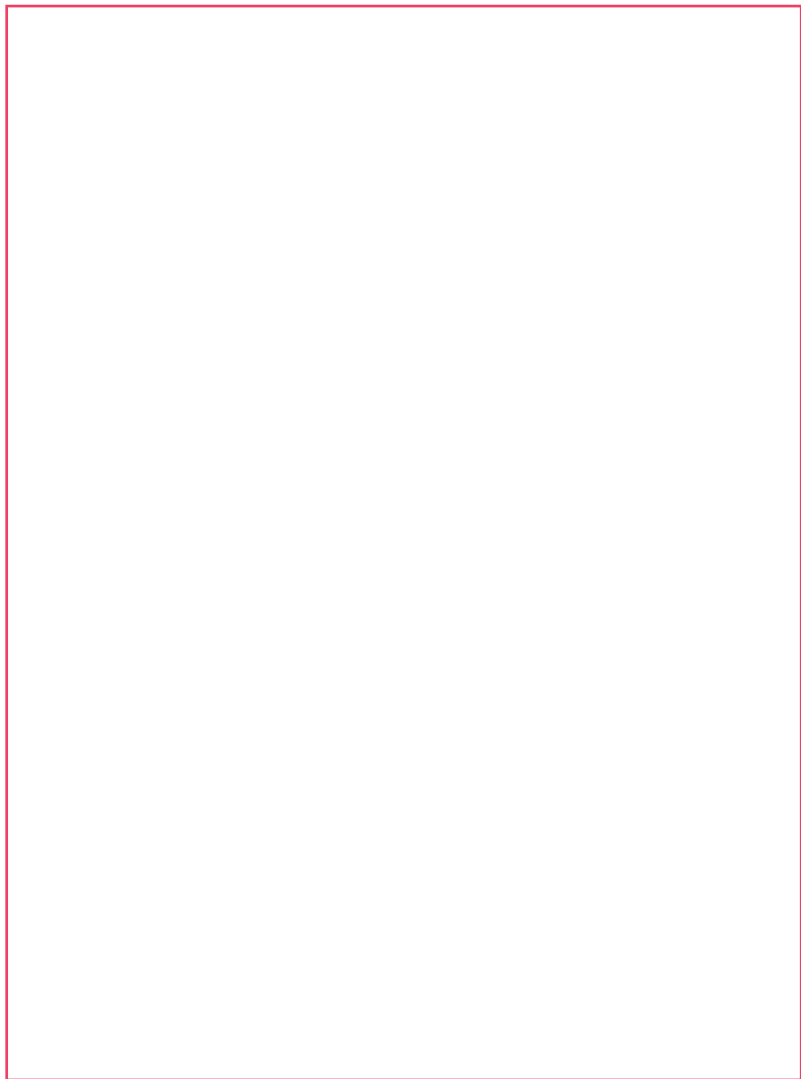



Certificado de conformidad sanitaria.
Atestado de conformidade sanitária.
certificato di conformità sanitaria.
Βεβαίωση υγειονομικής συμμόρφωσης.
Certyfikat zgodności sanitarnej.
Декларация о соответствии санитарным нормам
Санитарлық талаптарға сәйкестік декларациясы
Декларация про відповідність санітарним нормам
Atestat de conformitate sanitară
Certificado de conformidade sanitária.
Declaration of sanitary conformity.
Attestation de conformité sanitaire

* Garantie 10 ans / 10 años de garantía / Garantia de 10 anos / Garanzia 10 Anni / Εγγύηση 10 ετών / Gwarancja 10-letnia / Гарантія 10 років / Кенісiлiк 10 жыл / Гарантія 10 років /
Garantie 10 ani / 10 años de garantía / 10-year guarantee

ADEO Services - 135 Rue Sadi Carnot - CS 00001
59790 RONCHIN - France

UA ТОВ «Леруа Мерлен Україна»,
вул. Поларна 17а, м. Київ 04201, Україна

Made in P.R.C 2018





OK

**TASK FORCE GREEN
DOT / SORTING
INSTRUCTION
2021**