

1	2	3	4
Số đơn hàng 1	Mã KH1 客户编号 3276000589822	Chất liệu 材料 Giấy Carton	Mã hình thức 料号 K909K
		Chỉ định 备注 ADEO-65	

90103990

Yêu cầu kỹ thuật:

1. In trên giấy trắng cắt bé thành phẩm đóng thành quyển, dùng ghim để đóng.
2. Kích thước khổ giấy A6,
3. In giống như bản vẽ, định lượng giấy 80g trở lên,

Giấy A6		80		grim2	Thiết kế Thiết kế Thiết kế		Ngày tháng Ngày tháng Ngày tháng		DT bề mặt DT bề mặt DT bề mặt		/		Hatisa 伊泰丽莎(越南)有限公司 ITALISA(VIEN NAM) CO.,LTD	
					Thẩm tra Thẩm tra Thẩm tra		Ngày tháng Ngày tháng Ngày tháng		Phiên bản Phiên bản Phiên bản		B0		Tên Tên Tên	
Ký hiệu 备注		Nội dung thay đổi-变更内容		Phương vị 方位	Kí lộn 颠倒	Ngày tháng 日期	Phê chuẩn 批准		Ngày tháng 日期	Đơn vị 单位	mm	Mã BV 版本号		90103990

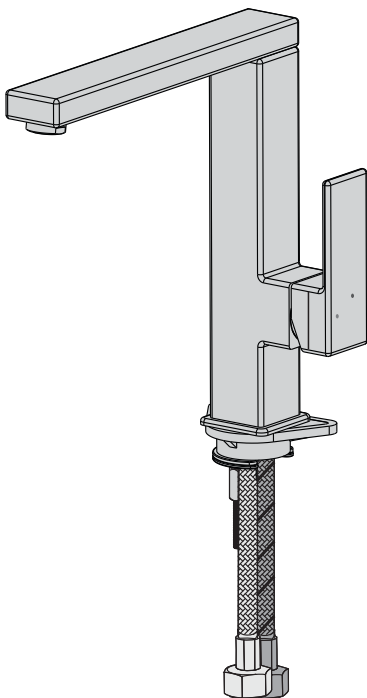

EAN CODE : 3276000589822
EAN CODE : 3276000596790
EAN CODE : 3276000632474

FR Manuel d'Instructions

ES Manual de Instrucciones

PT Manual de Instruções

IT Manuale di Istruzioni

EL Εγχειρίδιο Οδηγιών

PL Instrukcja Obsługi

RU Руководства по
Эксплуатации

KZ Пайдаланушы Нұсқаулығы

UA Інструкція з Експлуатації

RO Manual de Instrucțiuni

BR Manual de Instruções

EN Instructions Manual

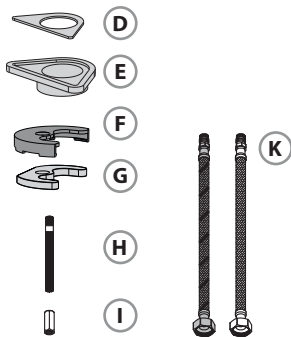
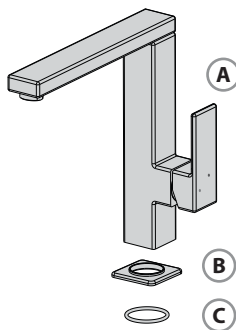
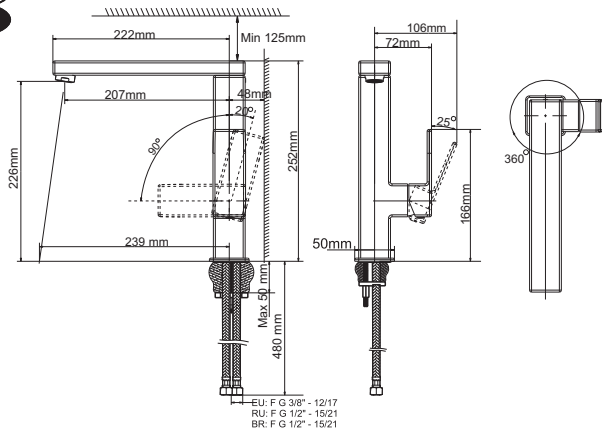

PH2
+





FR: Préparation / ES: Preparación / PT: Preparação / IT: Preparazione / EL: Προετοιμασία /
PL: Przygotowanie / RU: Подготовка / KZ: Дайындау / UA: Підготування / RO: Pregătire / BR: Preparação /
EN: Preparation



FR: Montage / ES: Montaje / PT: Montagem / IT: Montaggio / EL: Συναρμολόγηση /
PL: Montaż / RU: Сборка / KZ: Монтаждау / UA: Збірка / RO: Montaj / BR: Montagem /
EN: Assembly



FR: Utilisation eau chaude-eau froide/ ES: Utilización agua caliente-agua fría/ PT: Utilização água quente-água fria/
IT: Uso acqua calda-acqua fredda/ EL: Χρήση ζεστού-κρύου νερού/ PL: Użytkowanie zimnej wody-gorącej wody/
RU: использование горячей и холодной воды/ KZ: Суық және ыстық суды қолдану/
UA: використання гарячої - холодної води/ RO: Utilizare apă caldă-apă rece/
BR: Uso de água quente e fria/ EN: Using hot and cold water



FR: Changement de cartouche/ ES: Cambio de cartucho/ IT: Cambio cartuccia/ PT: Mudança de cartucho/
EL: Αλλαγή φωτογείου/ PL: Wymiana wkładu / RU: Смена картриджа/ KZ: Картриджді ауыстыру/
UA: Заміна картриджа/ RO: Schimbare cartuş/ BR: Substituição de cartucho/ EN: Replacing the cartridge



FR: Changement de moussEUR/ ES: Cambio de aieador/ PT: Mudança de arejador/ IT: Cambio rompigeetto/
EL: Αλλαγή αεράτορα/ PL: Wymiana perlatora / RU: Смена аэратора/ KZ: Ауақанықтырғышты ауыстыру/
UA: Заміна аератора/ RO: Schimbare aerator/ BR: Substituição do aerador/ EN: Replacing the aerator



FR: Changement de flexibles/ ES: Cambio de flexibles / PT: Mudança de flexíveis/ IT: Cambio flessibili/
EL: Αλλαγή λάστιχων/ PL: Wymiana wężyków instalacyjnych / RU: Смена гибкого шланга для смесителя/
UA: Заміна гнучкого шланга для змішувача/ KZ: Қоспалауышқа арналған иілгіш шлангты ауыстыру/
RO: Schimbare furtune flexibile/ BR: Substituição das mangueiras/ EN: Replacing the hoses





FR: Préparation / ES: Preparación / PT: Preparação / IT: Preparazione / EL: Προετοιμασία /
PL: Przygotowanie / RU: Подготовка / KZ: Дайындау / UA: Підготування / RO: Pregătire /
BR: Preparação / EN: Preparation

1

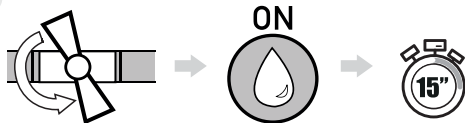

2

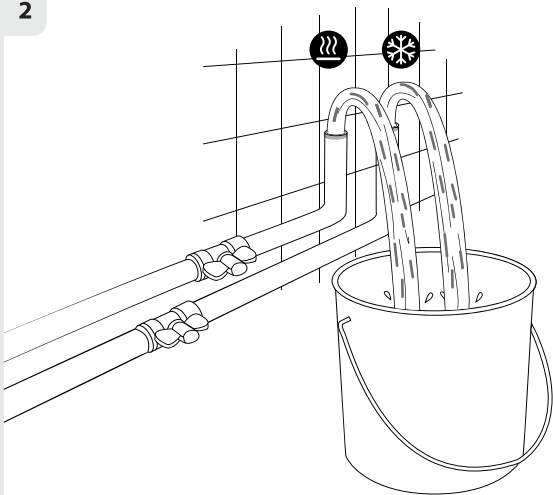

3

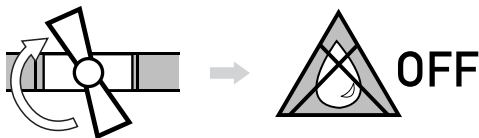

FR: Montage / ES: Montaje / PT: Montagem / IT: Montaggio / EL: Συναρμολόγηση /
PL: Montaż / RU: Сборка / KZ: Монтаждау / UA: Збірка / RO: Montaj / BR: Montagem /
EN: Assembly



1

1

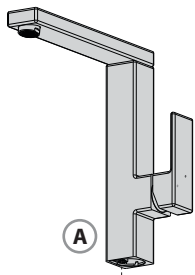

A



H



2

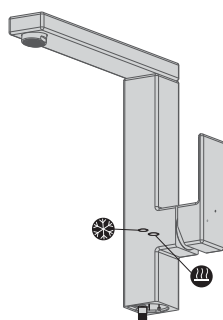

K

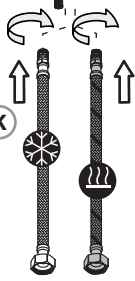

K

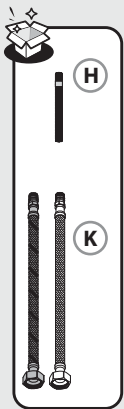

H

K

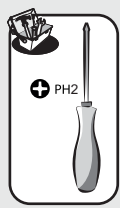

PH2



B



C



2

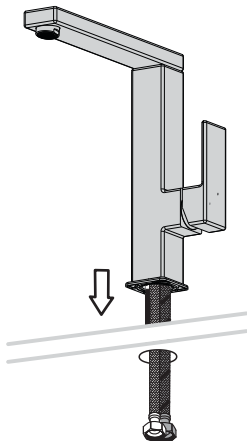
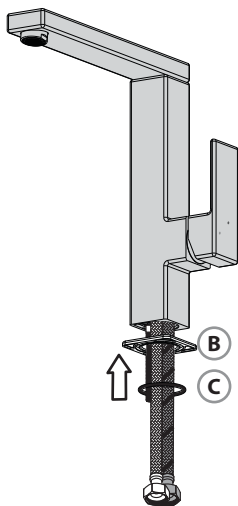



D



E



F



G



I



11



3



A



11 → 50
mm mm

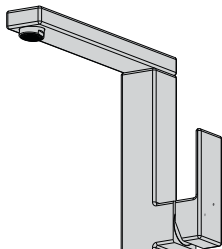

11 → 50
mm mm

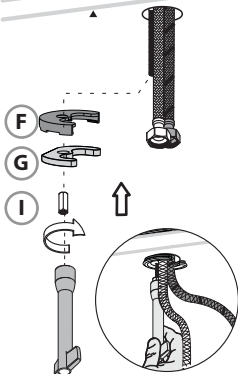

B



0,1 → 10
mm mm

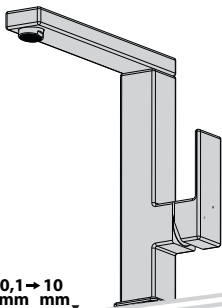

0,1 → 10
mm mm

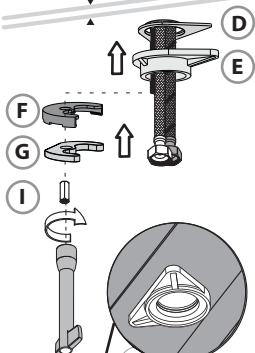

E

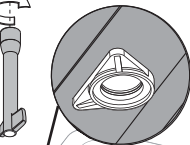

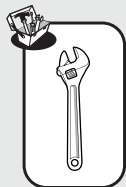

4

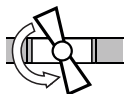
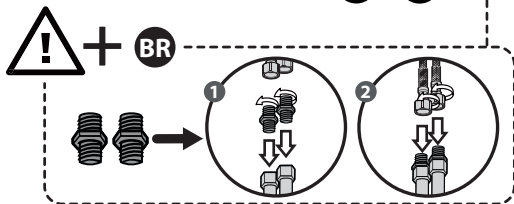
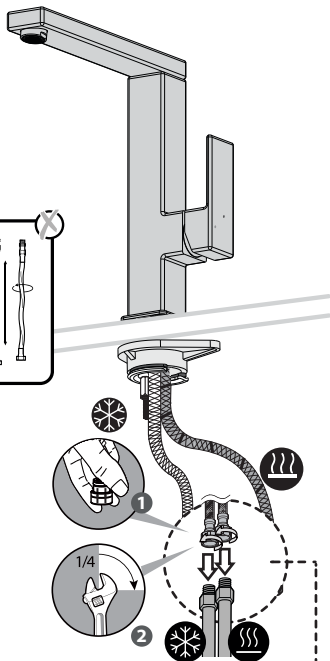
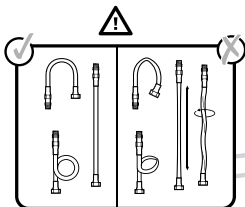
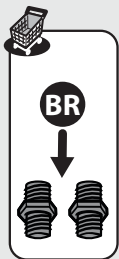



FR: Utilisation eau chaude-eau froide/ ES: Utilización agua caliente-agua fría/ PT: Utilização água quente-água fria/
IT: Uso acqua calda-acqua fredda/ EL: Χρήση ζεστού-κρύου νερού/ PL: Użytkowanie zimnej wody-gorącej wody/
RU: использование горячей и холодной воды/ KZ: Суық және ыстық суды қолдану/
UA: використання гарячої - холодної води/ RO: Utilizare apă caldă-apă rece/
BR: Uso de água quente e fria/ EN: Using hot and cold water

1

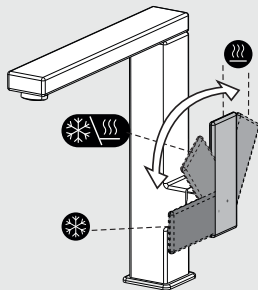
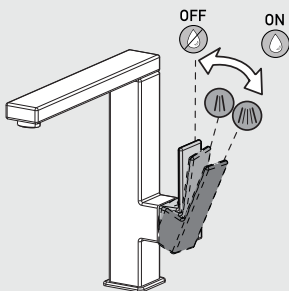

2

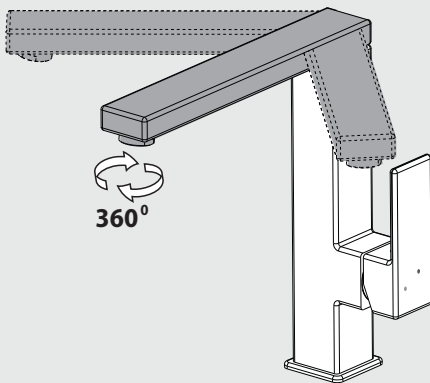

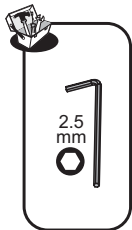

FR: Changement de cartouche/ ES: Cambio de cartucho/ IT: Cambio cartuccia/ PT: Mudança de cartucho/
EL: Αλλαγή φυσίγγιου/ PL: Wymiana wkładu / RU: Смена картриджа/ KZ: Картриджді ауыстыру/
UA: Заміна картриджа/ RO: Schimbare cartuş/ BR: Substituição de cartucho/ EN: Replacing the cartridge

1



OFF

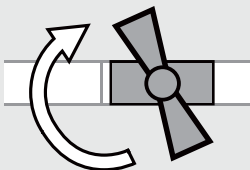

2

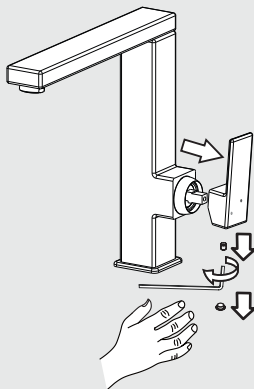

3

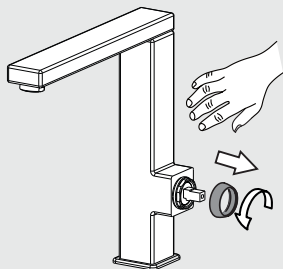
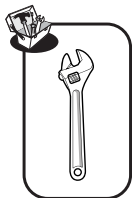

4

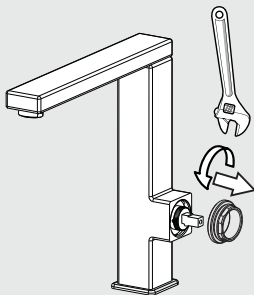



FR: Changement de cartouche/ ES: Cambio de cartucho/ IT: Cambio cartuccia/ PT: Mudança de cartucho/
EL: Αλλαγή φυσιγγίου/ PL: Wymiana wkładu / RU: Смена картриджа/ KZ: Картриджді ауыстыру/
UA: Заміна картриджа/ RO: Schimbare cartuş/ BR: Substituição de cartucho/ EN: Replacing the cartridge

5

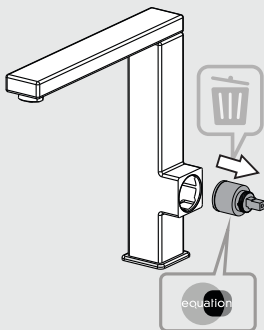

6

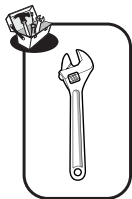
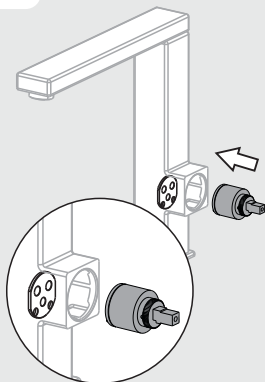

7

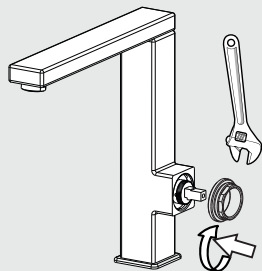

8

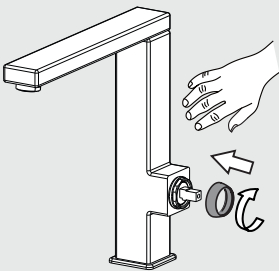

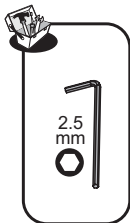

FR: Changement de cartouche/ ES: Cambio de cartucho/ IT: Cambio cartuccia/ PT: Mudança de cartucho/
EL: Αλλαγή φιοσίγγιου/ PL: Wymiana wkładu / RU: Смена картриджа/ KZ: Картриджді ауыстыру/
UA: Заміна картриджа/ RO: Schimbare cartuş/ BR: Substituição de cartucho/ EN: Replacing the cartridge

9

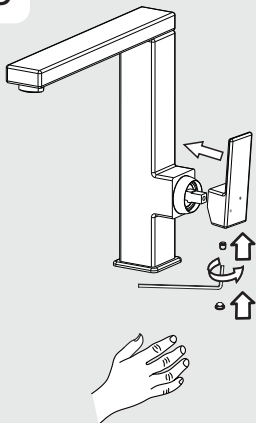

10



ON

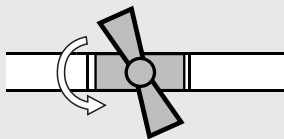



FR: Changement de mousseur/ ES: Cambio de aireador/ PT: Mudança de arejador/ IT: Cambio rompigitto/
 EL: Αλλαγή αεράτορα / PL: Wymiana perlatora / RU: Смена аэратора/ KZ: Ауақанықтырғышты ауыстыру/
 UA: Заміна аератора/ RO: Schimbare aerator/ BR: Substituição do aerador/ EN: Replacing the aerator

1

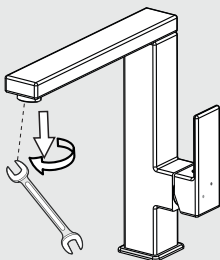
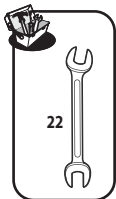

2

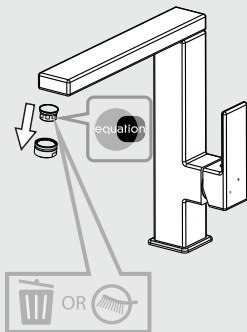

Nettoyage / Limpieza / Limpeza / Pulizia / Καθαρισμός /
 Czyszczenie / Чистка / Очищення / Surátare / Cleaning

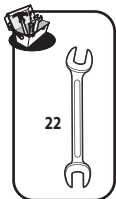

3

FR Vinaigre IT Aceto RU Уксус RO Oțet
 ES Vinagre EL Ξύδι KZ Сірке су BR Vinagre
 PT Vinagre PL Ocet UA Оцет EN Vinegar

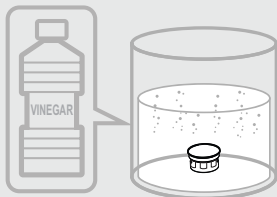

4

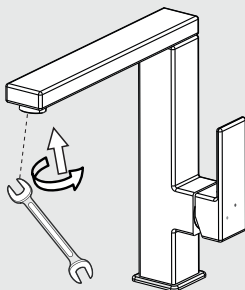



FR: Changement de flexibles/ ES: Cambio de flexibles/ PT: Mudança de flexíveis/ IT: Cambio flessibili/
EL: Αλλαγή λάστιχων/ PL: Wymiana wężyków instalacyjnych/ RU: Смена гибкого шланга для смесителя/
UA: Заміна гнучкого шланга для змішувача/ KZ: Қоспалауышқа арналған иілгіш шлангты ауыстыру/
RO: Schimbare furtune flexibile/ BR: Substituição das mangueiras/ EN: Replacing the hoses



1

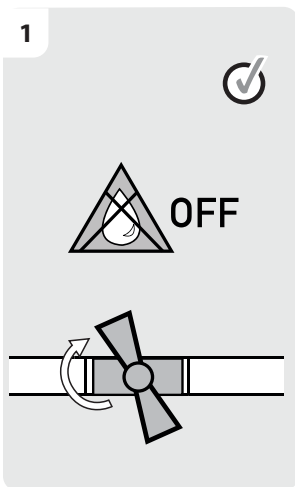

2

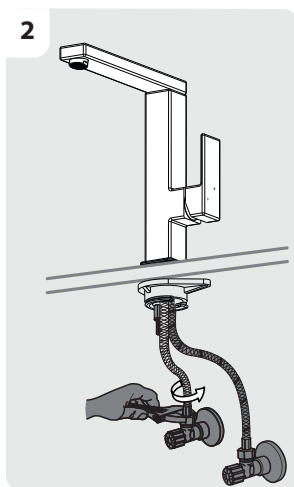

3

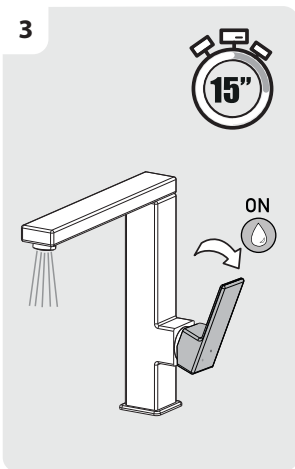

4

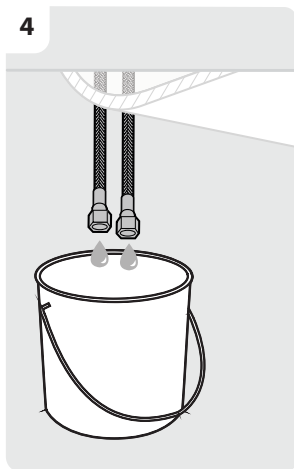

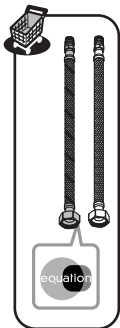

FR: Changement de flexibles/ ES: Cambio de flexibles / PT: Mudança de flexíveis/ ПТ: Cambio flessibili/
 EL: Αλλαγή λάστιχων/ PL: Wymiana wężyków instalacyjnych / RU: Смена гибкого шланга для смесителя/
 UA: Заміна гнучкого шланга для змішувача/ KZ: Қоспаулышқа арналған иілгіш шлангты ауыстыру/
 RO: Schimbare furtune flexibile/ BR: Substituição das mangueiras/ EN: Replacing the hoses

5

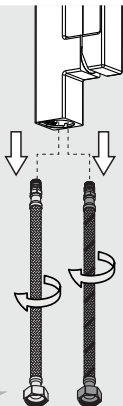

6

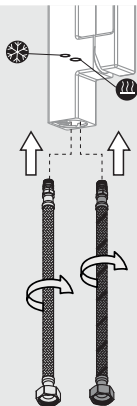

7

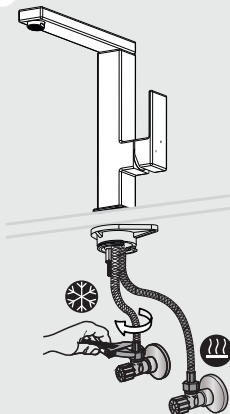

8

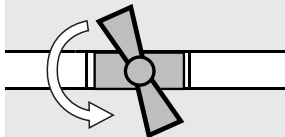



Eau claire / Agua limpia / Água limpa / Acqua pulita / Καθαρό νερό / Czysta woda / Чистая вода / таза су / Чиста вода /
Apă curată / Água limpa / Clean water



Sans solvant / Sin disolvente / Sem solventes / Senza solventi / Χωρίς διαλυτικά / Bez rozpuszczalnika / Без растворителя /
еріткішсіз / Без розчинника / Fără solvent / Sem solventes / Solvent-free

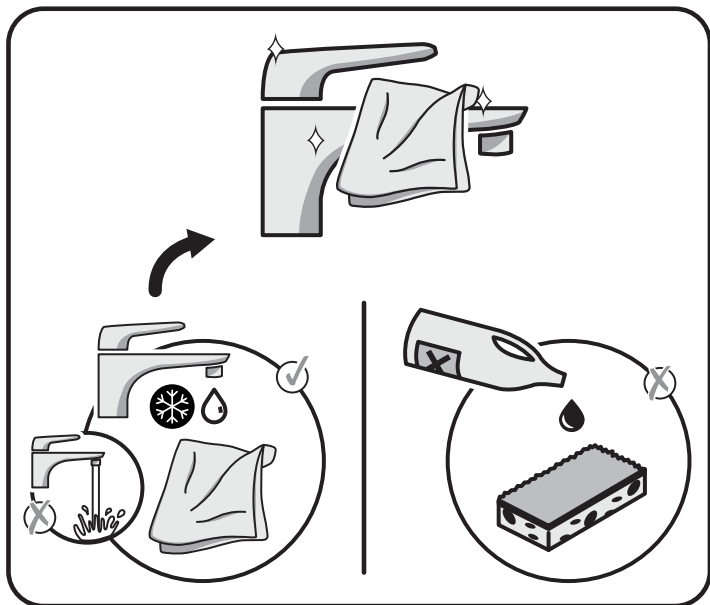

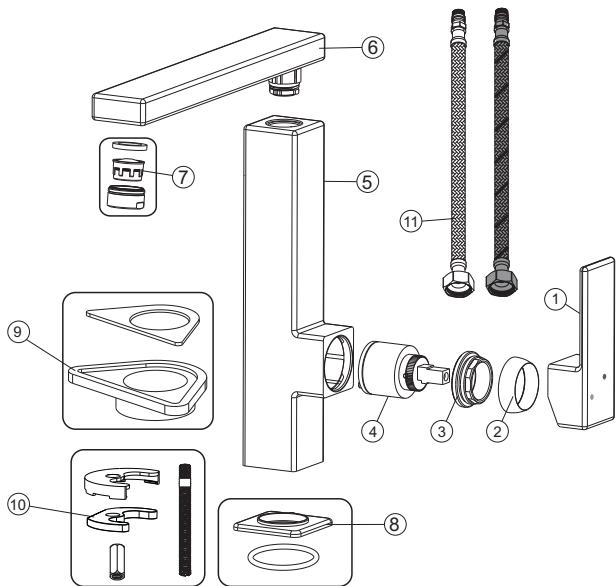

No	Description	Code No.	Q'Ty	Remark
1	Handle	5610Y809A0XCP	1	
2	Beauty Cover	5614B210A0PCP	1	
3	Pressing Nut	5613B197A0ANT	1	
4	Cartridge	EN35 SD COLD DUE MIRROR 08EN35S2002	1	
5	Body	5690A809K0ACP	1	
6	Spout	5620A809K0ACP	1	
7	Aerator	40.0005.033	1	
8	Base	5633Y242A0XCP	1	
9	Triangle base	5635Q319A0PNT	1	
10	Fixing set	5635Q362A0ACP	1	
11	Supply hose	TAQ-PEX-DN6-ACB H3/8-M8x1 L12-550	2	







Made in Vietnam 2018

ADEO Services - 135 Rue Sadi Carnot - CS 00001
59790 RONCHIN - France

UA ТОВ «Леруа Мерлен Україна»,
вул. Полярна 17а, м. Київ 04201, Україна

RU ООО ЛЕРУА МЕРЛЕН ВОСТОК, 141031, Московская
область, Мытищинский район, г. Мытищи,
Осташковское шоссе, д.1, РОССИЯ

BR Importado e distribuído por LEROY MERLIN
CIA BRASILEIRA DE BRICOLAGEM
Rua Domingas Galleteri Blotta, 315 - Interlagos - CEP
04455-360 São Paulo - SP - Brazil CNPJ: 01.438.784/0001-05
CALM (Central de Atendimento Leroy Merlin) -4020.5376 (capitais)
e 0800.0205376 (demais regiões)

SA Imported by Adeo South Africa (PTY) LTD T/A Leroy
Merlin - Leroy Merlin Greenstone Store - Corner
Blackrock Street and Stoneridge Drive, Greenstone
Park Ext 2, Edenvale, 1610 - Johannesburg,
Gauteng, South Africa

KZ «Леруа Мерлен Казахстан» ЖШС Қазақстан
Республикасы, 050000, Алматы қ., Қонаев
көшесі, 77, «ParkView» БО, БК., 07 с/ф.

