

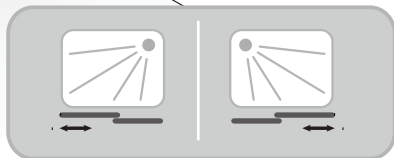

**10**  
YEARS  
Guarantee

REMIX

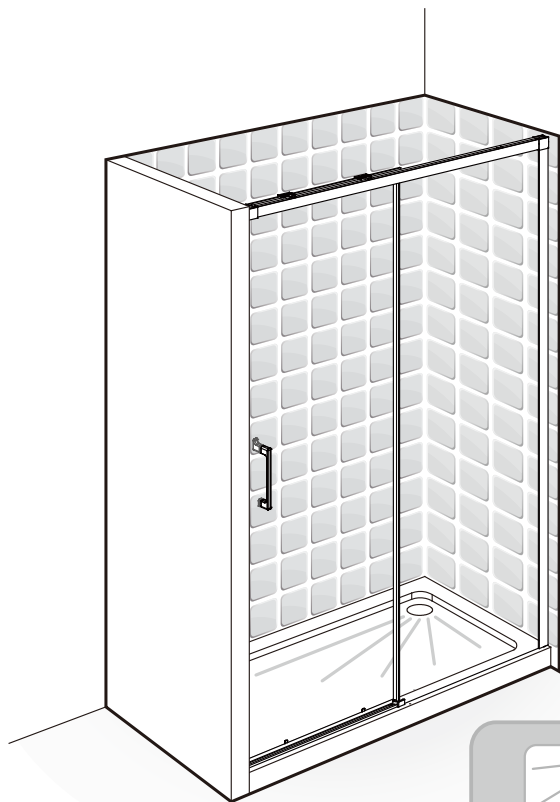

EAN CODE :

3276000693031	3276000693017	3276000693024	3276000693062	3276000693048
3276000693055	3276000693109	3276000693086	3276000693093	3276000693208
3276000693147	3276000693154	3276000693239	3276000693215	3276000693222



**FR** Notice de Montage -  
Utilisation - Entretien

**ES** Instrucciones de Montaje,  
Utilización y Mantenimiento

**PT** Instruções de Montagem,  
Utilização e Manutenção

**IT** Istruzioni per il Montaggio,  
l'Uso e la Manutenzione

**EL** Εγχειρίδιο συναρμολόγησης,  
χρήσης και συντήρησης

**PL** Instrukcja Montażu,  
Użytkowania i Konserwacji

**RU** Руководство По Сборке  
и Эксплуатации

**KZ** Жинау, пайдалану және  
техникалық қызмет  
көрсету нұсқаулығы

**UA** Керівництво По Збірці  
і Експлуатації

**RO** Manual asamblare,  
utilizare și întreținere

**EN** Assembly - Use -  
Maintenance Manual





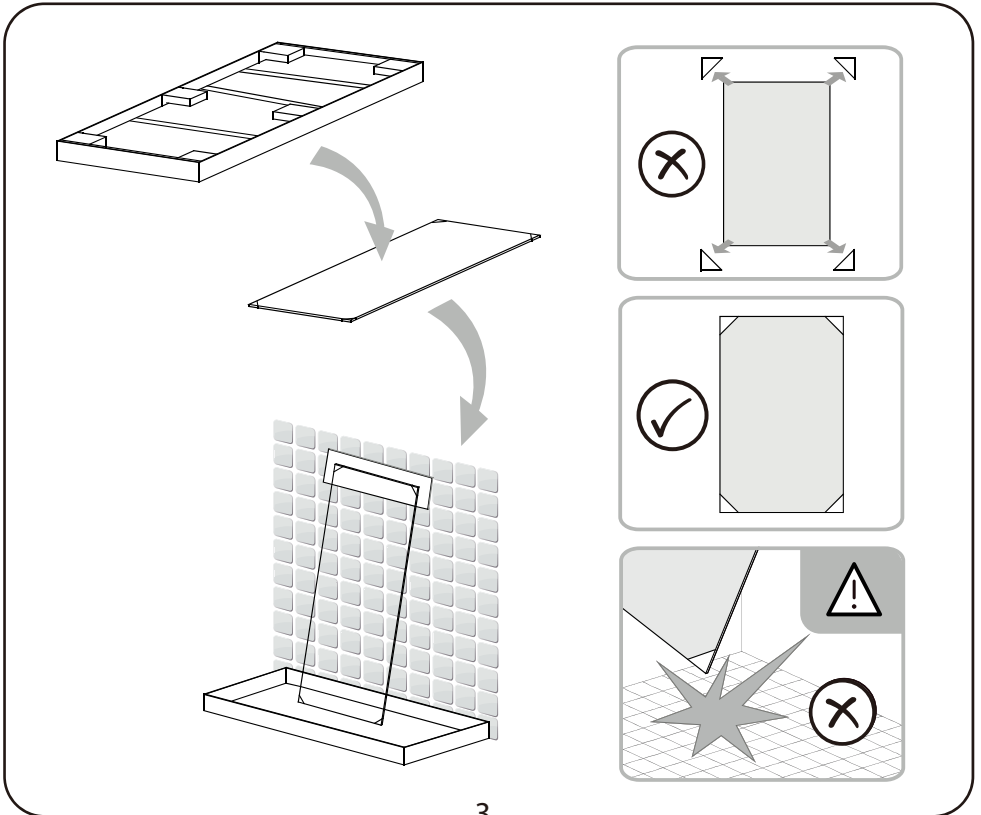

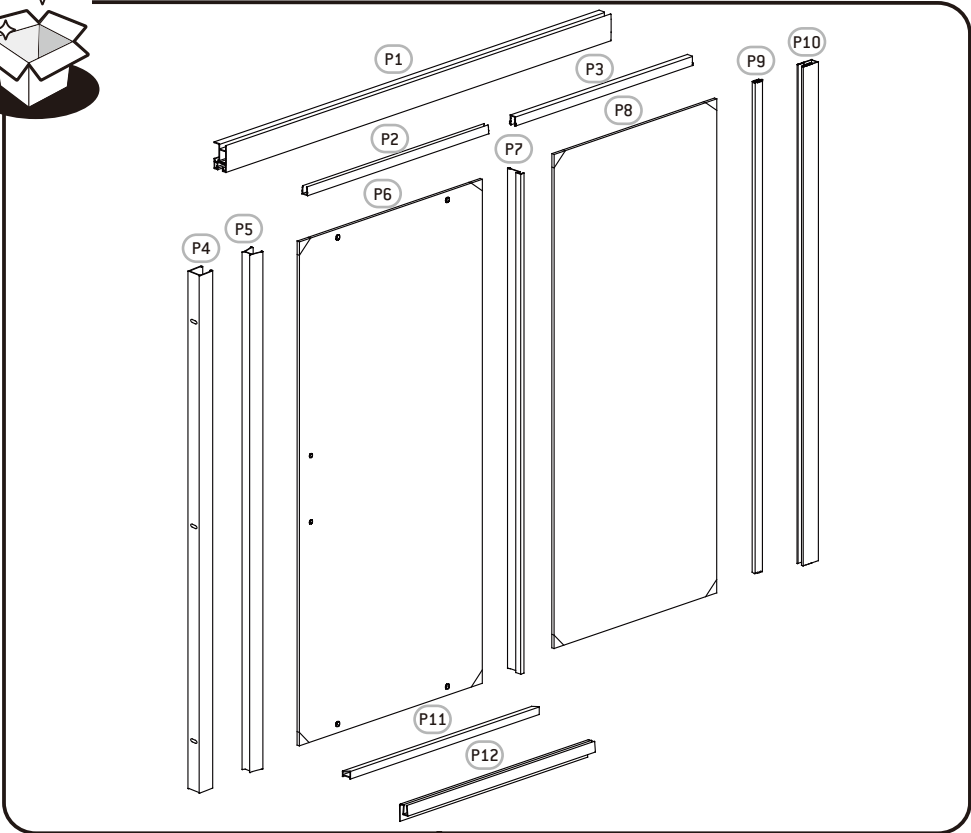

- FR** Nous vous remercions d'avoir acheté ce produit. Nous vous conseillons de lire attentivement la notice d'installation, d'utilisation et d'entretien. Nous avons conçu ce produit pour vous apporter entière satisfaction.  
Si vous avez besoin d'aide l'équipe de votre magasin est à votre disposition pour vous accompagner.
- ES** Le agradecemos haber comprado este producto. Le recomendamos leer atentamente el manual de instalación, uso y mantenimiento. Este producto ha sido diseñado para proporcionarle plena satisfacción.  
Si necesita alguna ayuda, el personal de la tienda estará a su disposición para guiarle.
- PT** Agradecemos a sua preferência por este produto. Aconselhamo-lo a ler o manual de instalação, utilização e manutenção com atenção. Criámos este produto para sua completa satisfação.  
Se precisar de ajuda, a equipa da sua loja está à sua disposição para o acompanhar.
- IT** Grazie per aver acquistato questo prodotto. Vi raccomandiamo di leggere attentamente il manuale di installazione, utilizzo e manutenzione. Questo prodotto è stato progettato per offrirvi la massima soddisfazione.  
Per ricevere assistenza, il personale del punto vendita è a vostra disposizione.
- EL** Ευχαριστούμε για την αγορά σας αυτού του προϊόντος. Σας συμβουλεύουμε να διαβάσετε προσεκτικά τις οδηγίες εγκατάστασης, χρήσης και συντήρησης. Σχεδιάσαμε αυτό το προϊόν για να σας προσφέρει πλήρη ικανοποίηση.  
Αν χρειάζεστε βοήθεια, η ομάδα του καταστήματος από το οποίο αγοράσατε το προϊόν είναι στη διάθεσή σας
- PL** Dziękujemy za zakup produktu firmy. Zalecamy, aby uważnie przeczytać instrukcję instalacji, użytkowania i konserwacji. Ten produkt marki zaprojektowaliśmy, aby spełnić wszystkie Państwa oczekiwania.  
W razie potrzeby pracownicy sklepu służą Państwu pomocą i są do Państwa dyspozycji.
- RU** Благодарим Вас за приобретение изделия. Рекомендуем внимательно прочитать инструкции по установке, эксплуатации и техническому обслуживанию. Изделие разработано, чтобы доставить Вам удовольствие.  
Если Вам потребуется помощь, консультанты Вашего магазина находятся в Вашем распоряжении.
- KZ** Өнімін сатып алғаныңыз үшін алғыс білдіреміз. Орнату, қолдану және қызмет көрсету жөніндегі нұсқаулықтарды мұқият оқып шығуға кеңес береміз. Біз бұл өнімін сізді толықтай қанағаттаныру үшін жасап шығардық.  
Егер сізге көмек қажет болса сіздің бөлшектеп сататын дүкеніңіздегі топ сізге жәрдем береді.
- UA** Дякуємо вам за покупку цього виробу. Ми радімо вам уважно прочитати інструкції з установлення, експлуатації та технічного обслуговування. Ми розробили цей виріб для того, щоб він приносив вам задоволення.  
Якщо вам потрібна допомога, співробітники вашого магазину готові допомогти вам
- RO** Vă mulțumim pentru achiziționarea acestui produs. Vă sfătuim să citiți cu atenție instrucțiunile de instalare, de utilizare și de întreținere. Am conceput acest produs pentru a vă furniza satisfacție totală.  
Dacă aveți nevoie de ajutor, echipa magazinului de cumpărare este la dispoziția dumneavoastră pentru a vă asista.
- EN** Thank you for purchasing this product. We recommend that you read the installation, user and maintenance instructions carefully. We have designed this product to ensure your complete satisfaction.  
If you require assistance, the team at your retailer is on hand to help you.













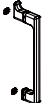







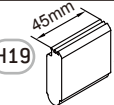

REMIX	
1000 - 1400mm	(H1 - H26) (H33)
1600 - 1700mm	(H1 - H33)

-  x11
-  x3  
ST 4x45mm
-  x7  
ST 4x45mm
-  x1  
ST 4x30mm

-  x4  
M 4x16mm
-  x2  
M 4x9mm
-  x1
-  x1
-  x1
-  x1

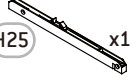
-  x2
-  x1
-  x1
-  x1
-  x1
-  x1

-  x1
-  x1
-  x2  
45mm
-  x1
-  x4
-  x1

-  x1  
4mm
-  x1  
3mm
-  x1  
4
-  x2  
ST 4x16mm
-  x1  
80mm
-  x2  
M 5x16mm



0 1 2 3 4 5 cm

H6  
x2



H5  
x4

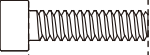

H33  
x2

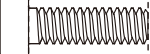

H26  
x2

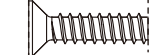

H4  
x1

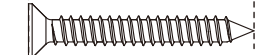

H1  
x11

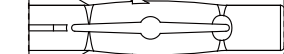

H3  
x7

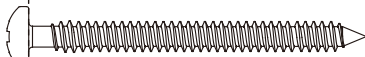

H2  
x3

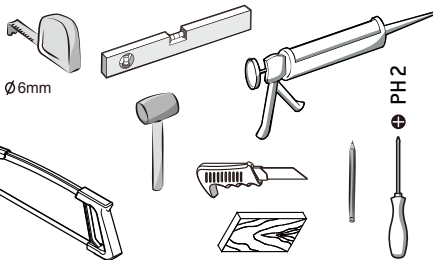
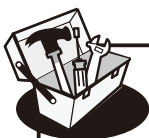
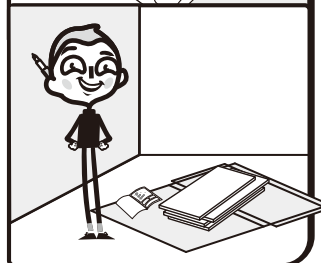
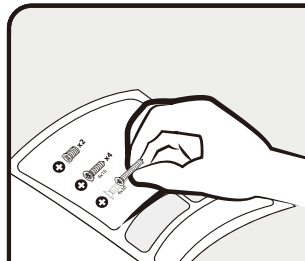



# 3M

Assemble with this side, with easy clean treatment, on the inside.

İze karşı işleme tabi tutulmuş bu yüz iç tarafa doğru konumlanmalıdır.

Cette face, avec un traitement facilement nettoiyable, doit être positionnée vers l'intérieur

Esta cara está tratada para facilitar su limpieza y se debe colocar hacia el interior

Esta face com tratamento para facilitar a limpeza, deve ficar voltada para o interior

Questo lato, deve essere posizionato con il trattamento easy clean all'interno.

Эта сторона, обработанная средством против образования накипи, должна быть обращена вовнутрь.

Страна, оброблена засобом проти накипу, повинна бути звернена всередину.

Această față, tratată pentru curățare ușoară, trebuie poziționată spre interior

Strona z powłoką zapewniającą łatwe czyszczenie powinna być skierowana do wewnątrz.

Αυτή η όψη, με επεξεργασία για εύκολο καθαρισμό, πρέπει να τοποθετηθεί προς το εσωτερικό.

V.7 2014

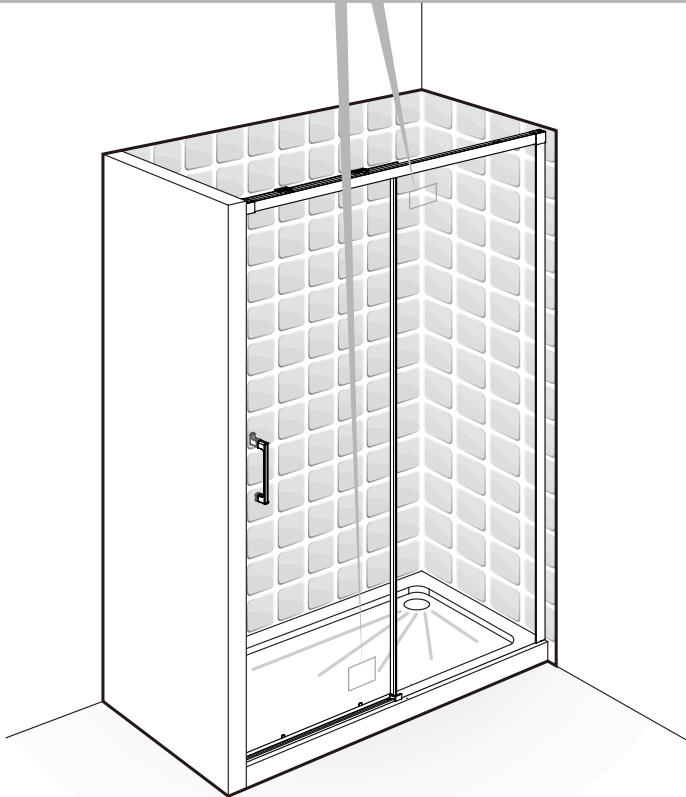



**FR:** Préparation / **ES:** Preparación / **PT:** Preparação / **IT:** Preparazione / **EL:** Προετοιμασία /  
**PL:** Przygotowanie / **RU:** Подготовка / **KZ:** Дайындау / **UA:** Підготування / **RO:** Pregătire /  
**EN:** Preparation

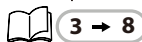

3 → 8



**FR:** Montage / **ES:** Montaje / **PT:** Montagem / **IT:** Montaggio / **EL:** Συναρμολόγηση /  
**PL:** Montaż / **RU:** Сборка / **KZ:** Монтаждау / **UA:** Збірка / **RO:** Montaj / **EN:** Assembly



9 → 48



**FR:** Entretien / **ES:** Mantenimiento / **PT:** Manutenção / **IT:** Manutenzione / **EL:** Συντήρηση /  
**PL:** Konserwacja / **RU:** Уход / **KZ:** Және техникалық қызмет көрсету / **UA:** Догляд / **RO:** Întreținere /  
**EN:** Maintenance



49



**FR:** Mentions Légales & Consignes de Sécurité / **ES:** Instrucciones Legales y de Seguridad /  
**PT:** Avisos Legais e instruções de Segurança / **IT:** Istruzioni Legali e di Sicurezza /  
**EL:** Νομικό σημείωμα και οδηγίες ασφαλείας / **PL:** Uwagi Prawne i Instrukcja Bezpieczeństwa /  
**RU:** Руководство по технике безопасности и правовым нормам /  
**KZ:** Қауіпсіздік және құқықтық басшылық / **UA:** Керівництво з Техніки /  
**RO:** Manual privind siguranța / **EN:** Legal & Safety Instructions



50



- I**
- FR** Vérifiez que les chevilles murales fournies sont appropriées à votre mur (celles fournies dans l'emballage sont conçues pour le béton). Sinon, utilisez des vis et des chevilles murales adaptées au type de matériau de votre mur. Pour obtenir des conseils concernant les vis et les chevilles appropriées à votre mur, demandez à un vendeur spécialisé.
- ES** Compruebe que todos los tacos suministrados puedan ser utilizados con su pared (los incluidos en la caja son para hormigón). En caso contrario, utilice tornillos y tacos de pared apropiados para el material de su pared. Para información acerca de las fijaciones y tornillos apropiados para su pared, consulte con un asistente de ventas especializado.
- PT** Certifique-se de que as buchas fornecidas são adequadas à sua parede (as fornecidas na embalagem são para betão). Caso contrário, use parafusos e buchas adequados ao tipo de material da sua parede. Para se aconselhar acerca dos parafusos e buchas adequados à sua parede, fale com um assistente de vendas especializado.
- IT** Verificare che i tasselli da parete forniti siano compatibili con la propria parete (quelli forniti con l'articolo sono per cemento). Altrimenti, utilizzare viti e tasselli adatti per la superficie della propria parete. Per ottenere consigli e suggerimenti sulle viti e i tasselli più adatti alla propria parete, consultare un rivenditore specializzato.
- EL** Βεβαιωθείτε ότι οι παρεχόμενες στερεώσεις τοίχου είναι κατάλληλες για τον τοίχο σας (οι παρεχόμενες στη συσκευή προορίζονται για μπετό). Αλλιώς χρησιμοποιήστε βίδες και στερεώσεις τοίχου κατάλληλες για τον τύπο υλικού του τοίχου σας. Για να λάβετε συμβουλές σχετικά με τις κατάλληλες βίδες και τα εξαρτήματα για τον τοίχο σας, ρωτήστε έναν ειδικό πωλητή.
- PL** Prosimy sprawdzić, czy dostarczone kołki do ścian nadają się do użycia w posiadanej ścianie (kołki dostarczone w zestawie są przeznaczone do betonu). Jeśli tak nie jest, należy użyć śrub i kołków odpowiednich do materiału, z którego wykonana jest ściana. Aby uzyskać poradę w sprawie śrub i elementów montażowych odpowiednich do danego typu ściany, należy zwrócić się z pytaniem do wyspecjalizowanego sprzedawcy.
- RU** Убедитесь, что прилагаемые дюбеля подходят для ваших стен (входящие в комплект дюбеля предназначены для бетона). В противном случае используйте шурупы и дюбеля, соответствующие материалу стены. Для получения рекомендаций по выбору шурупов и крепежных деталей, подходящих для вашей стены, обратитесь к специалисту-консультанту.
- KZ** Жеткізілетін қабырға анкерінің (қаланған тастарды ұстастыратын темір) сіздің қабырғаңызға үйлесімділігін тексеріңіз (жиынтыққа кіретіні бетонға арналған). Олай болмаған жағдайда, қабырғаңыздың материалының түріне сәйкес бұрмашегелер мен қабырға анкерін пайдаланыңыз. Қабырғаңызға сәйкес бұрмашегелер мен бөлшектер туралы ақпарат алу үшін сату бөлімінің кеңесшісіне хабарласыңыз.
- UA** Перевірте, що анкери підходять для вашої стіни (ті, що постачаються в упаковці – для бетону). В іншому випадку використовуйте гвинти й стінові анкери, що відповідають матеріалу вашої стіни. Для отримання консультації щодо гвинтів й фітінгів для вашої стіни зверніться до відповідного продавця-консультанта.
- RO** Verificați ca toate ancorele de perete furnizate să fie adecvate pentru peretele dumneavoastră (cele furnizate în pachet sunt pentru beton). În caz contrar, folosiți șuruburi și ancore de perete adecvate pentru tipul de material din care este peretele dumneavoastră. Pentru a obține recomandări privind șuruburile și armăturile adecvate pentru peretele dumneavoastră, întrebați un vânzător specializat.
- EN** Check that wall anchors provided are suitable for your wall (those provided in the package are for concrete). Otherwise, use screws and wall anchors suited to the type of material of your wall. To obtain advice on the screws and fittings suited to your wall, ask a specialized sales assistant.



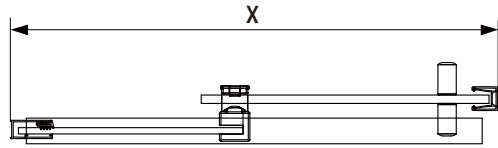

REMIX	X(mm)
1000mm	965-1005
1200mm	1165-1205
1400mm	1365-1405
1600mm	1565-1605
1700mm	1665-1705

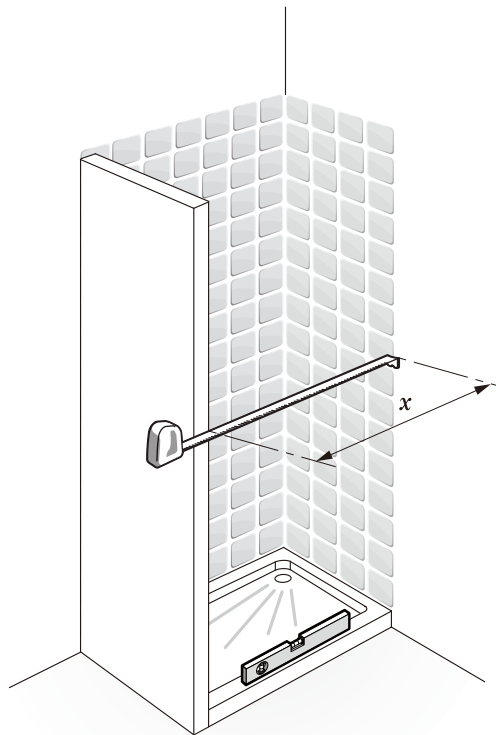



1

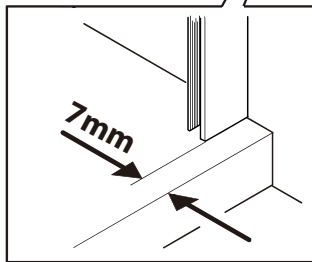
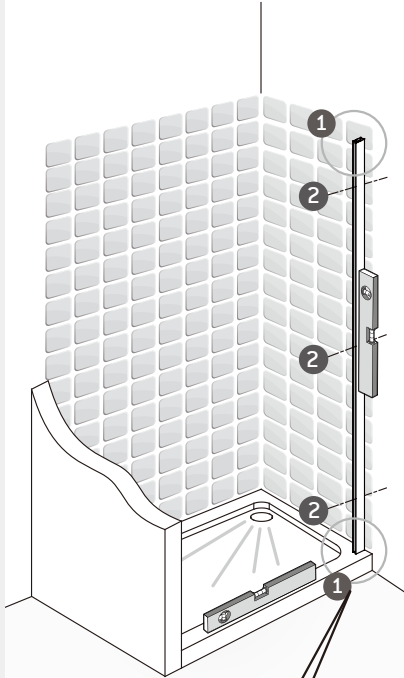
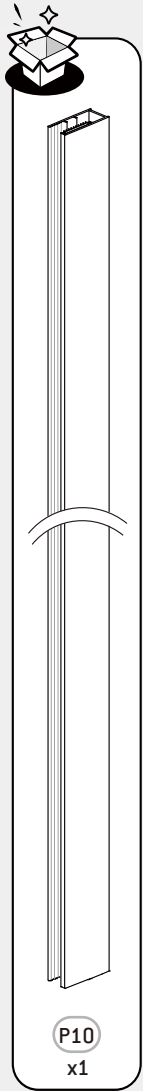

7mm minimum  
 7mm mínimo  
 7mm mínimo  
 7mm mínimo  
 7mm ελάχιστο  
 7mm minimalny  
 7mm минимальный  
 7mm минимум  
 7mm мінімальний  
 7mm minim  
 7mm minimum

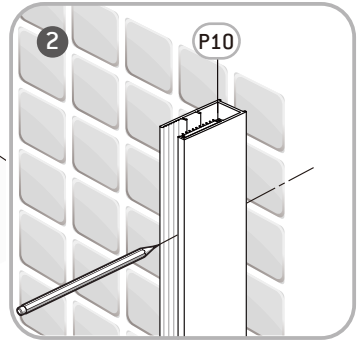
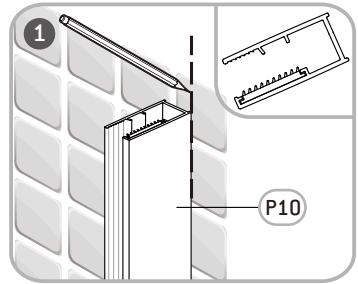
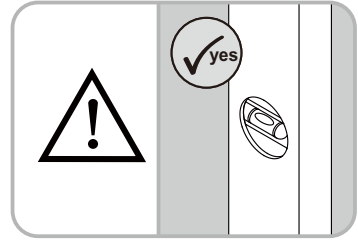

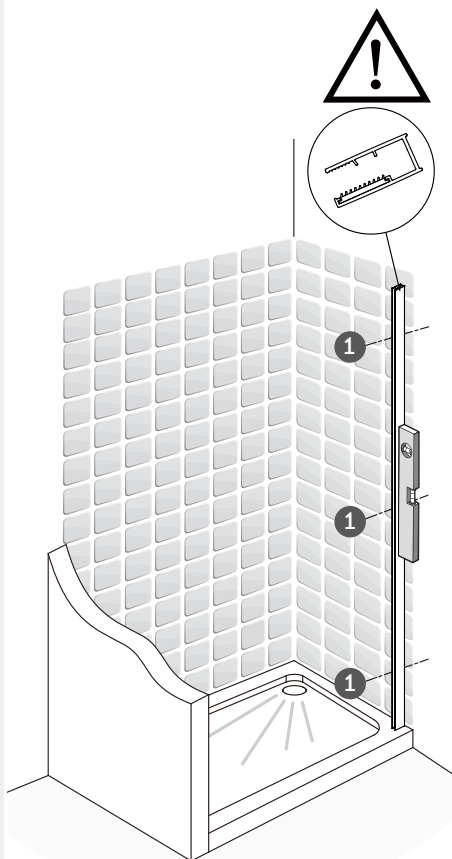
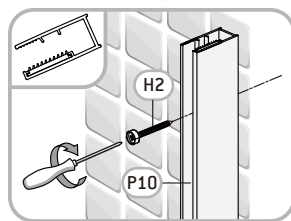
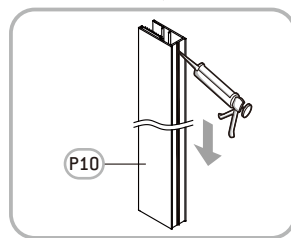
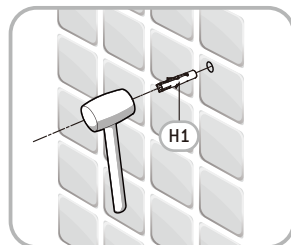
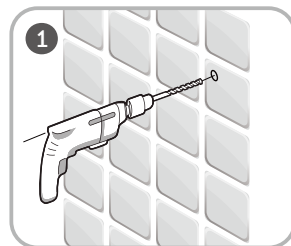
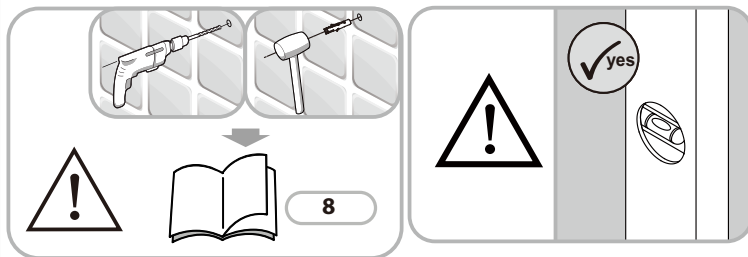
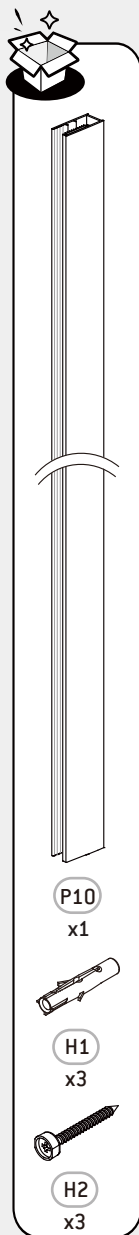

3

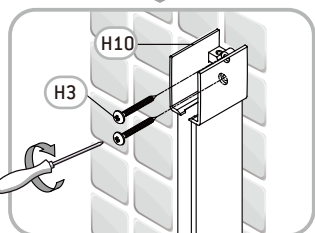
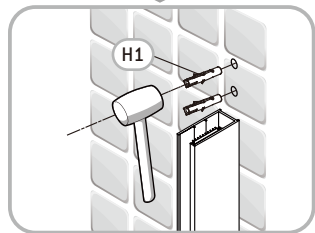
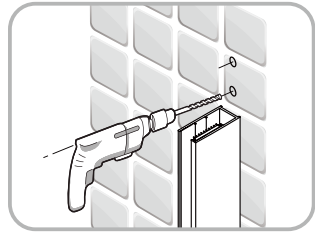
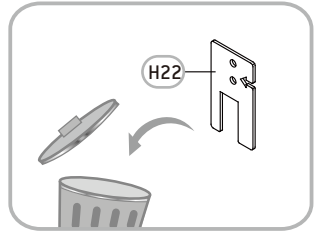
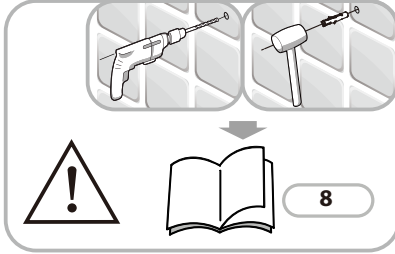
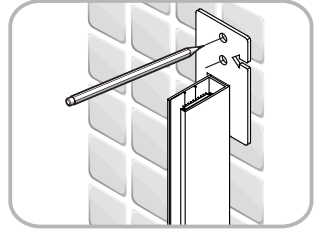
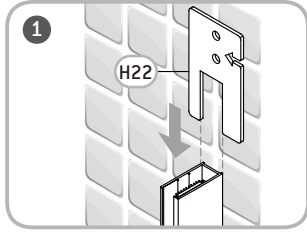
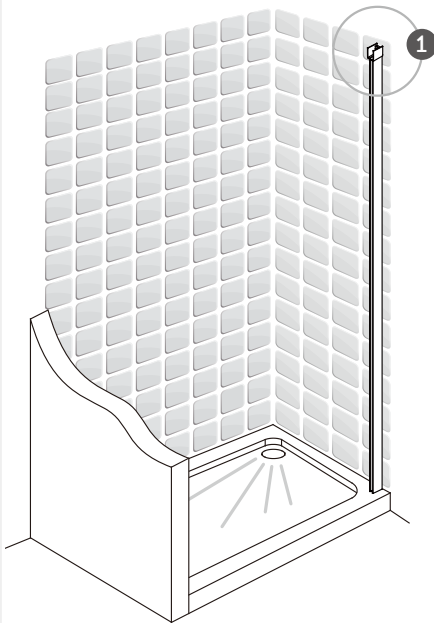
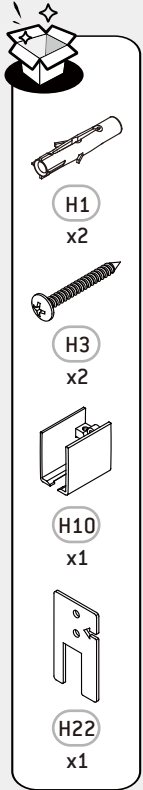

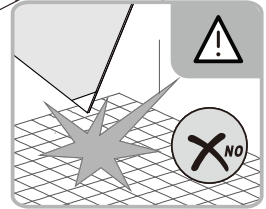
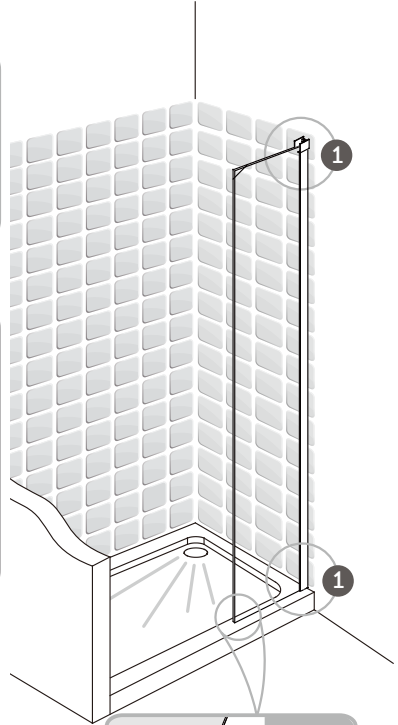
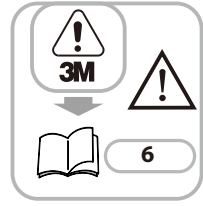
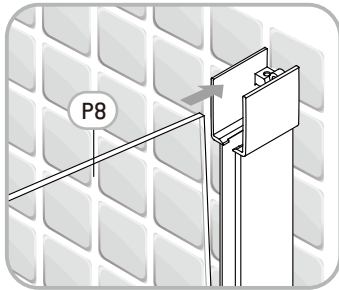
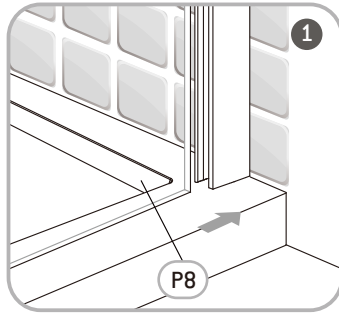
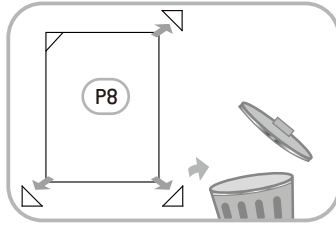
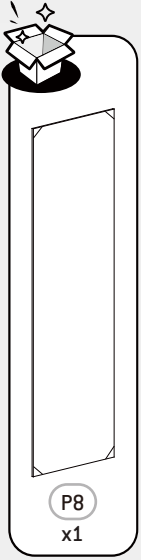

5

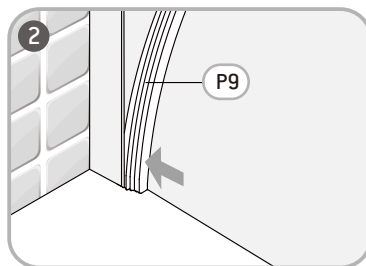
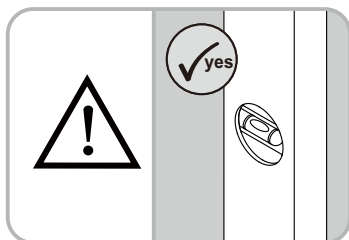
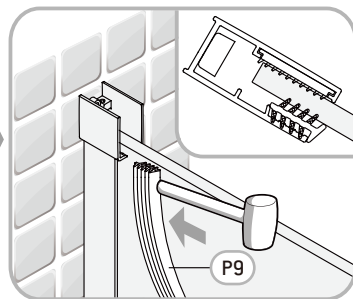
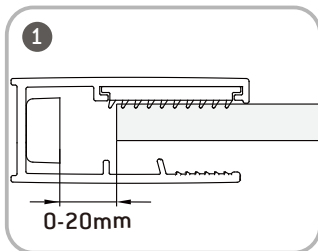
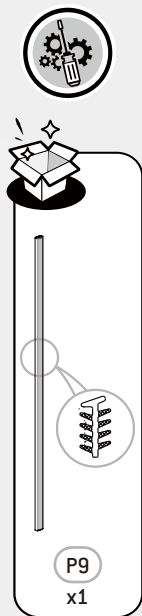

REMIX	L[mm]
1000mm	493-513
1200mm	593-613
1400mm	693-713
1600mm	693-713
1700mm	693-713

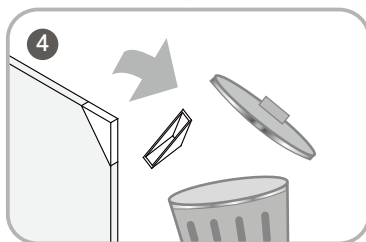
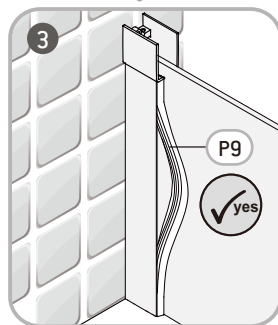
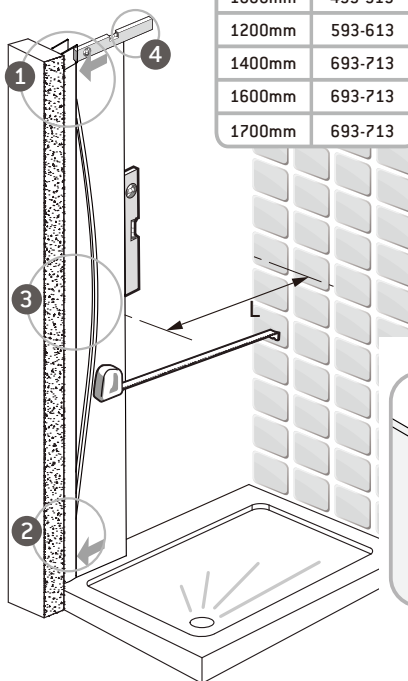



6

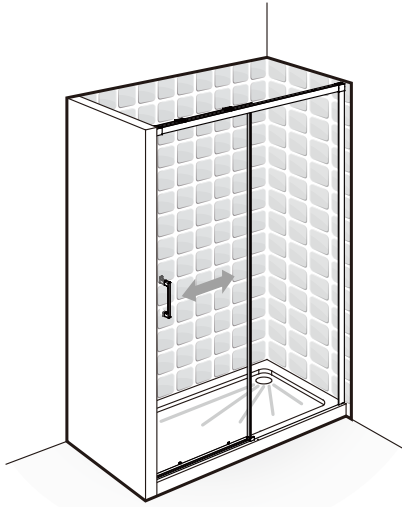

16 - 19

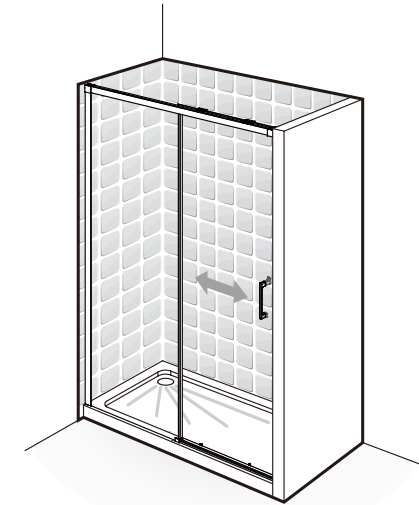

20 - 23



P1  
x1



H25  
x1



H26  
x2

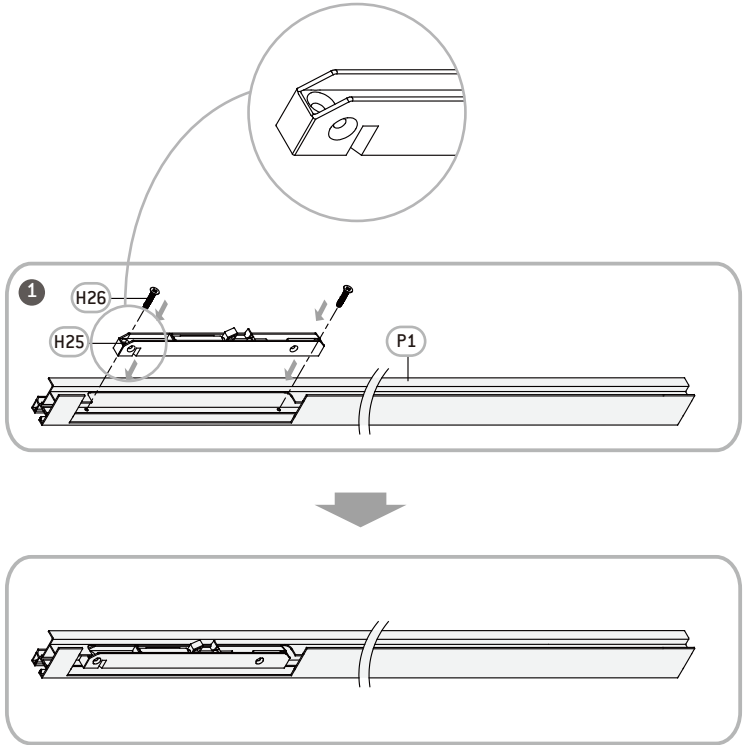





P1

x1

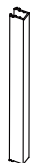

P2

x1



P3

x1

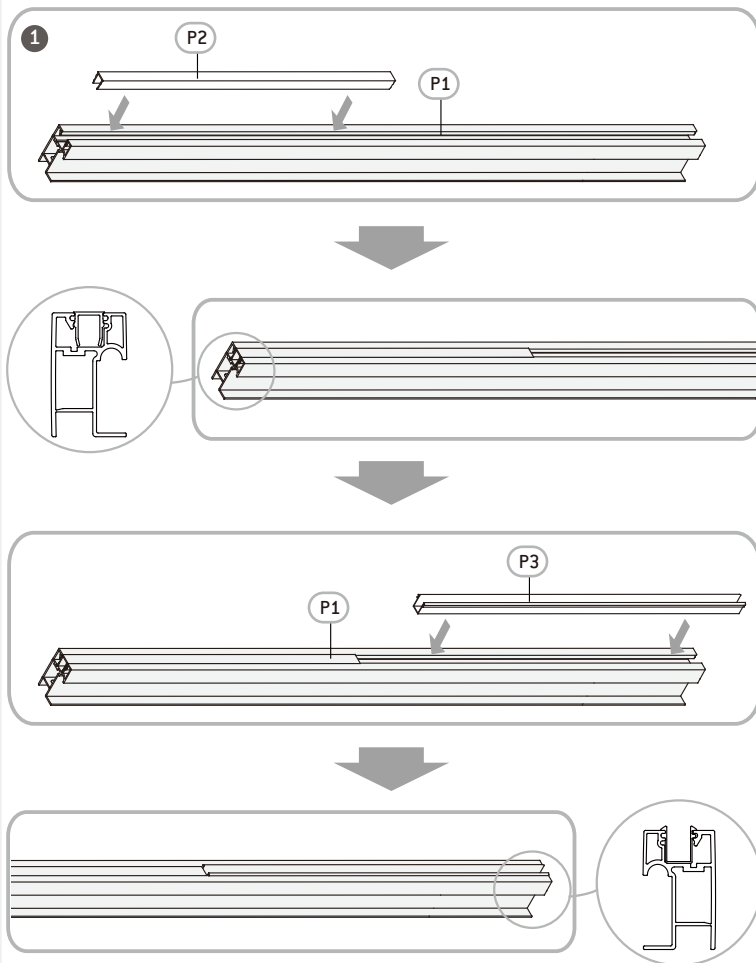



P1  
x1



H11  
x2



H19  
x2

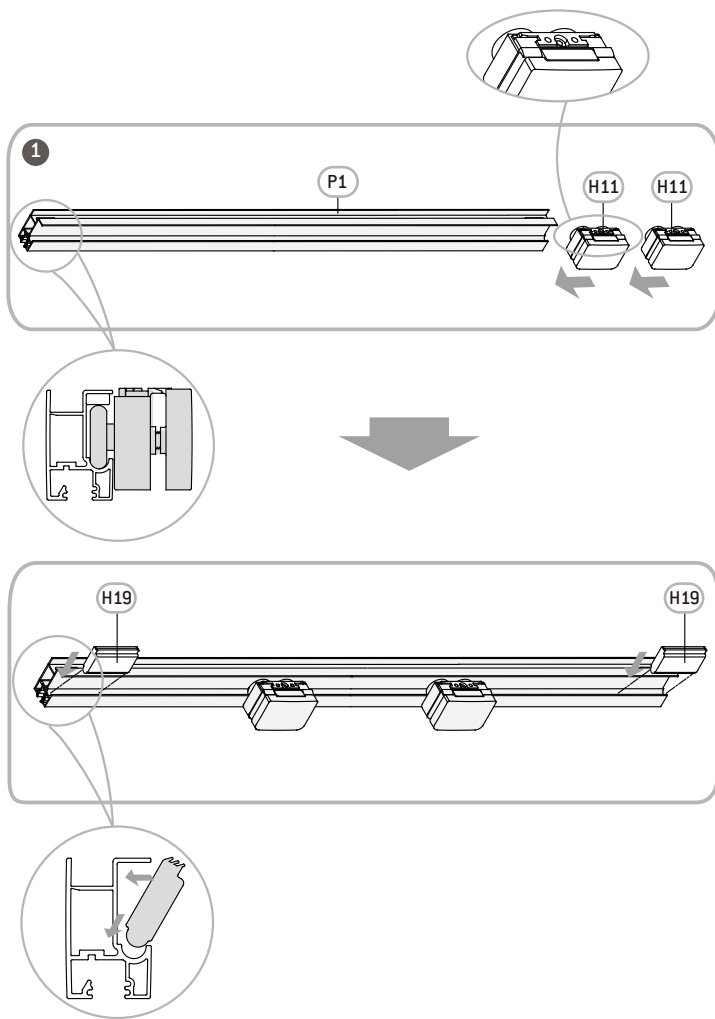

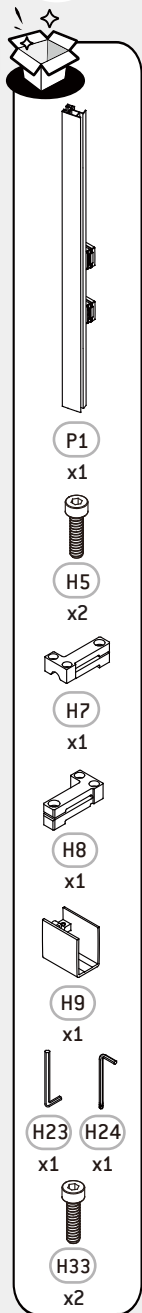

10

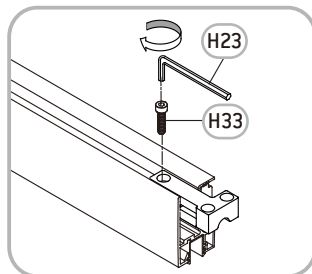
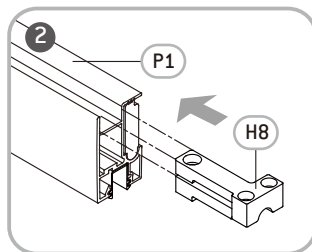
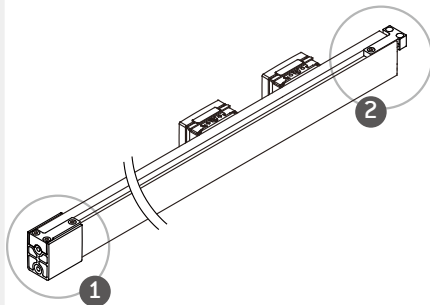
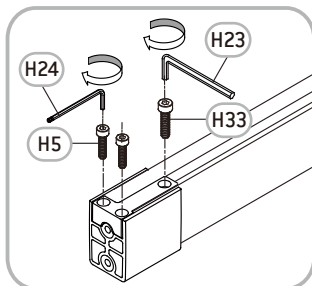
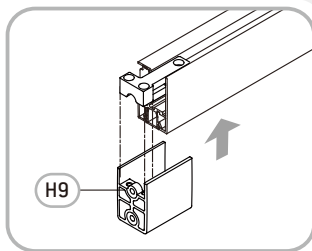
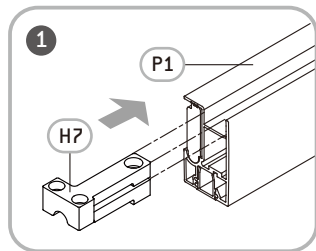

24



P1  
x1



H25  
x1



H26  
x2

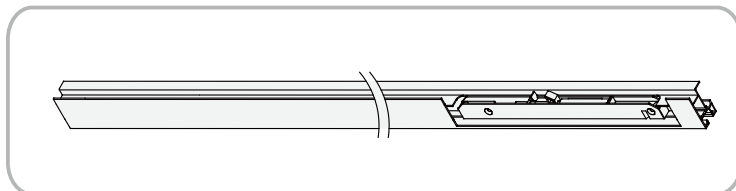
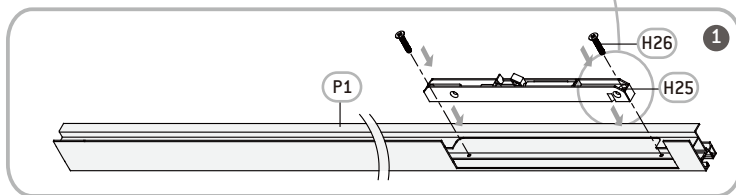
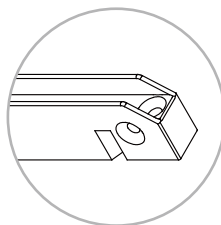



P1  
x1



P2  
x1

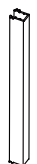

P3  
x1

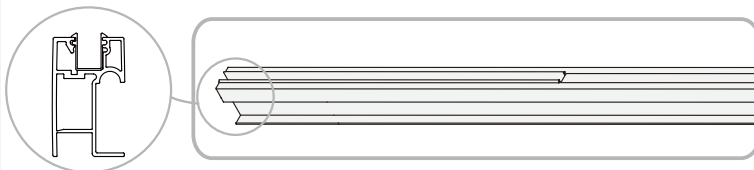
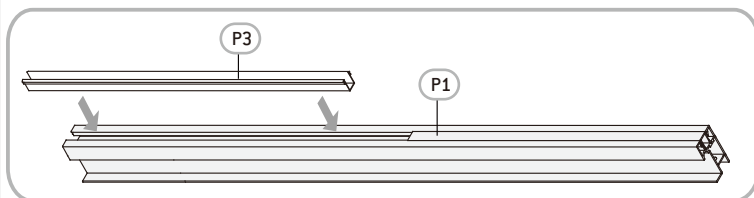
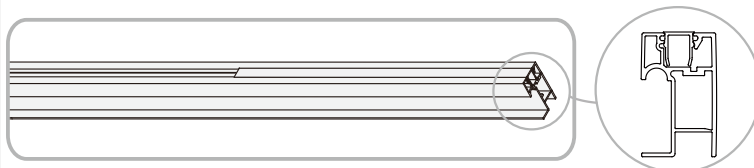
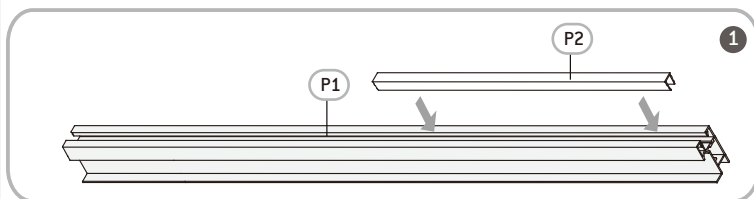



P1  
x1



H11  
x2



H19  
x2

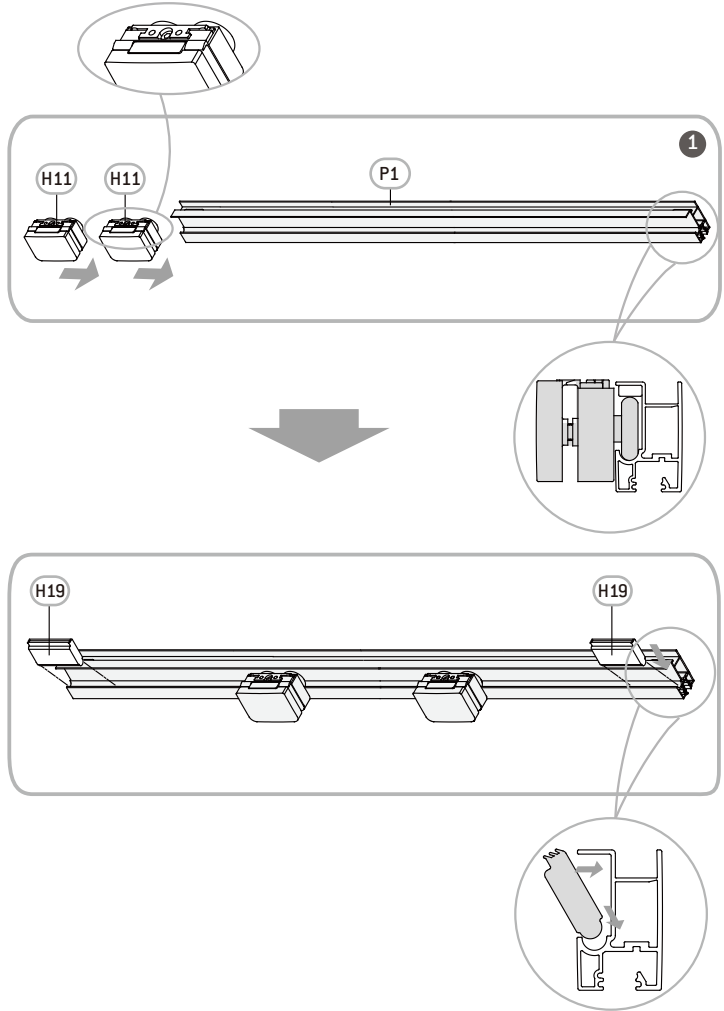

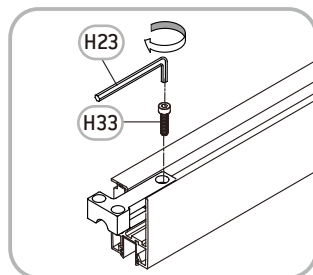
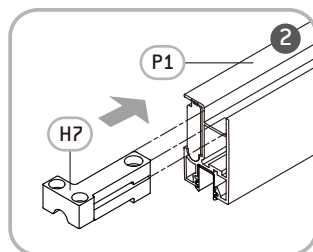
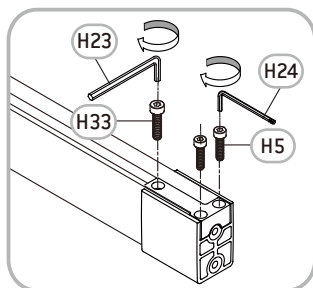
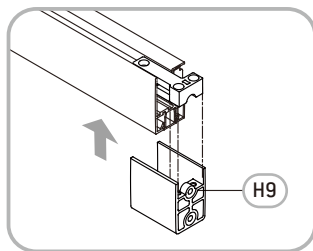
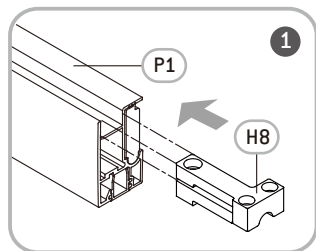
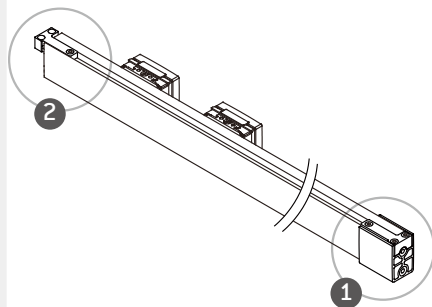
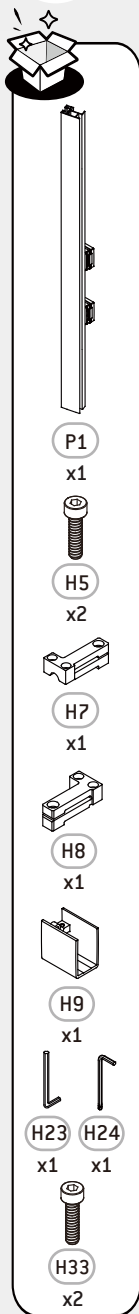

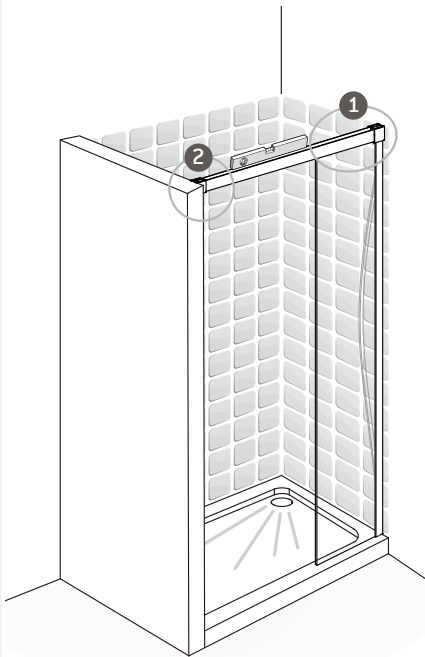
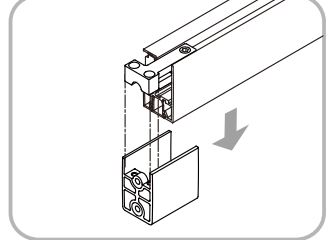
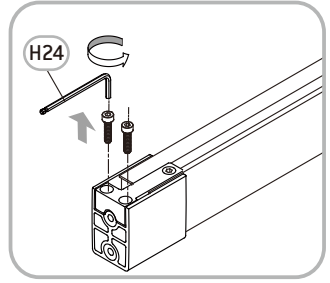
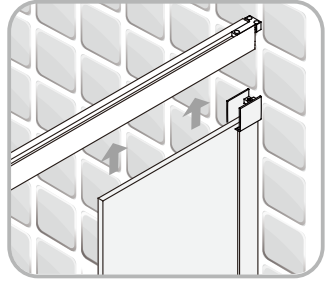
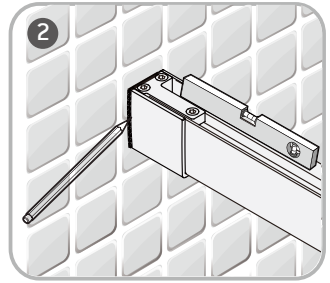
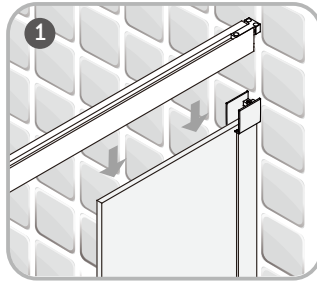
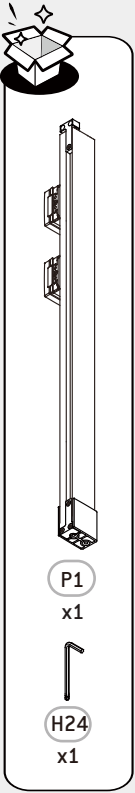





H1  
x2



H3  
x2



H9  
x1

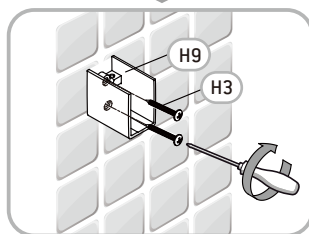
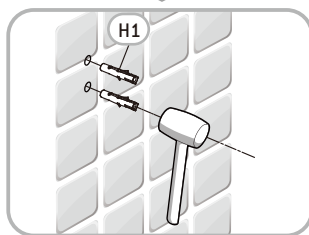
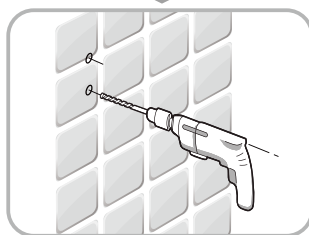
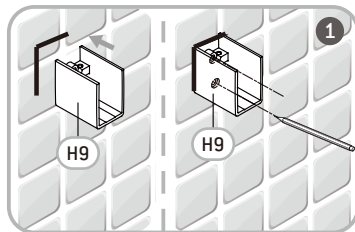
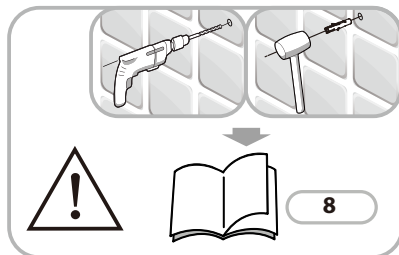
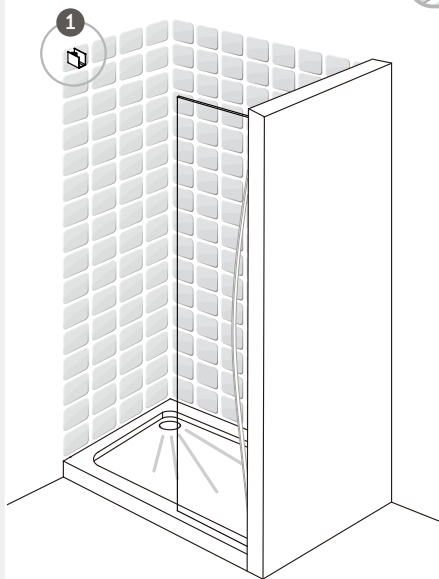

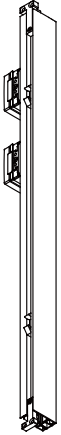

P1  
x1



H5  
x4



H24  
x1

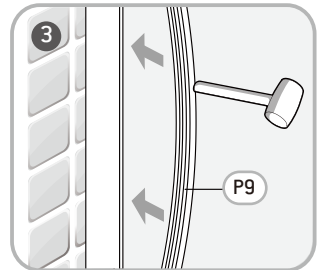
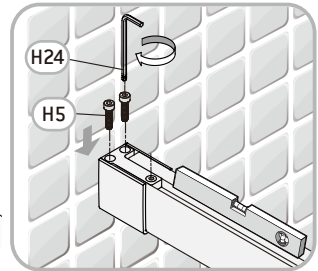
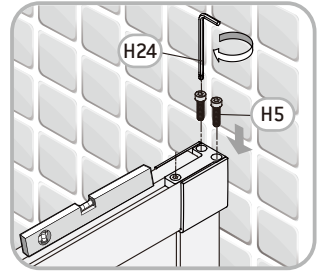
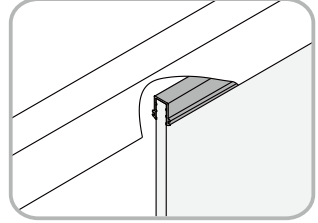
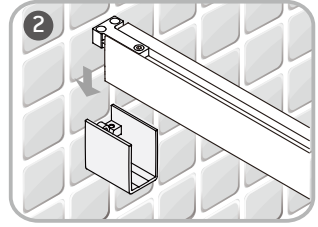
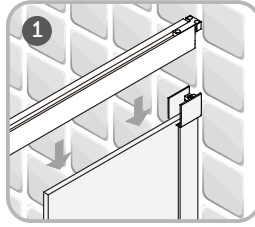
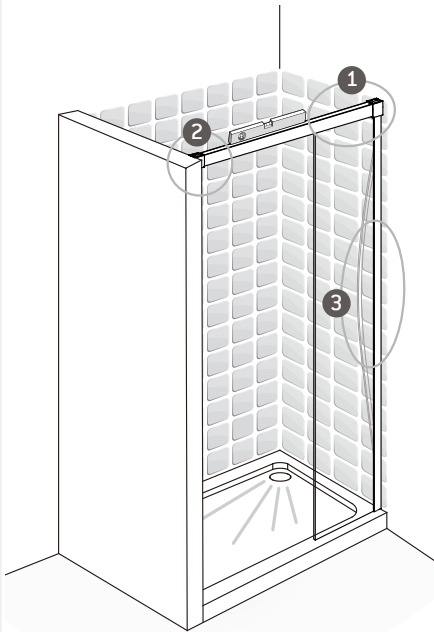



18

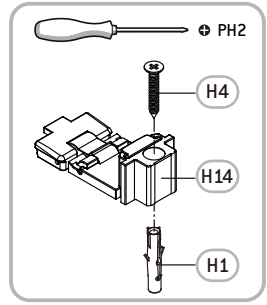
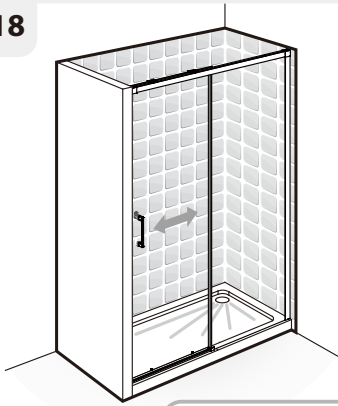

28 - 29

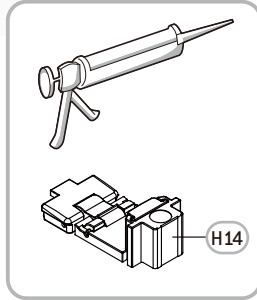

30

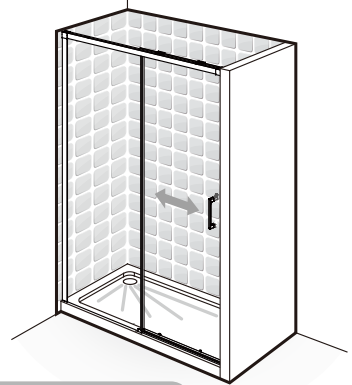
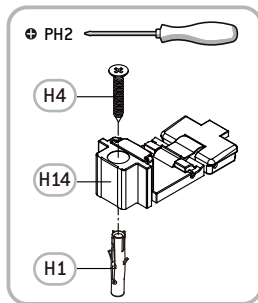

31 - 32

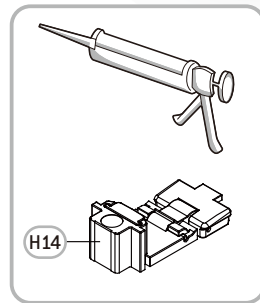

33



H1

x1



H14

x1



H15

x1

**FR** "Avertissement ! Vérifiez auprès du fabricant du receveur de douche que celui-ci peut être percé. Si ce n'est pas le cas, utilisez du silicone."

**ES** "¡Advertencia! Consulte con el fabricante del plato de la ducha si puede ser perforado. Utilice silicona en caso contrario."

**PT** "Aviso! Pergunte ao fabricante da base de chuveiro se esta pode ser perfurada. Se não for o caso, use silicone."

**IT** "Verificare con il produttore della colonna per la doccia se quest'ultima può essere forata. In caso contrario, utilizzare del silicone."

**EL** "Προειδοποίηση! Ρωτήστε τον κατασκευαστή ντουζιέρας εάν μπορεί να βιδωθεί. Εάν δεν γίνεται, χρησιμοποιήστε σιλικόνη."

**PL** "Ostrzeżenie! Prosimy sprawdzić u producenta brodzika, czy można w nim wiercić otwory. Jeśli nie, należy użyć silikonu."

**RU** "Предупреждение! Узнайте у производителя душевого поддона, допускается ли его сверление. В противном случае используйте силиконовый герметик."

**UA** "Увага! Зверніться до виробника душевого піддона щодо питання сверлення піддона. Якщо це неможливо, використовуйте силікон."

**RO** "Avertizare! Consultați-vă cu producătorul cădiței de duș pentru a afla dacă această poate fi găurită. Dacă nu poate fi găurită, utilizați silicon."

**EN** "Warning! Check with shower tray's maker if it can be drilled. If not, use silicon."

1



H14

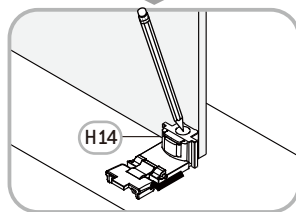
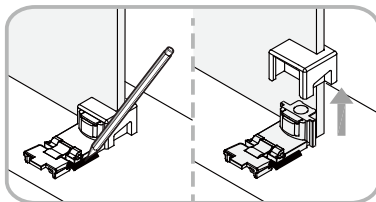
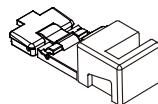
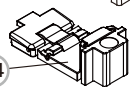

H14

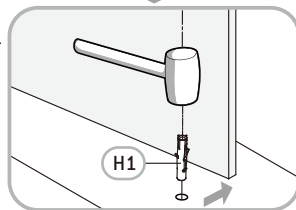
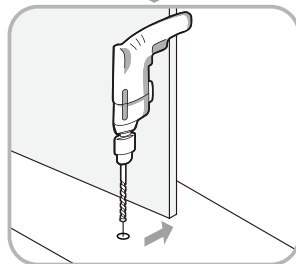

H1

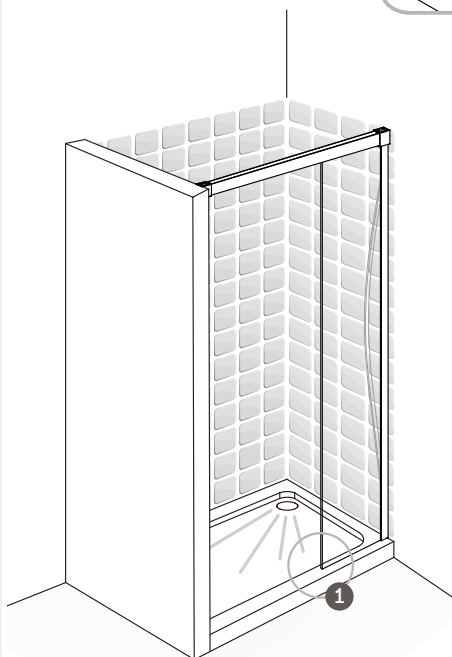



H4

x1



H14

x1



H15

x1

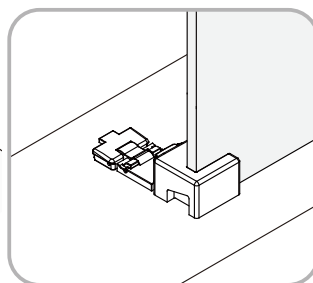
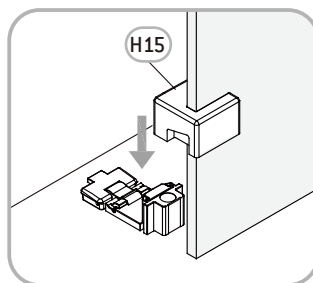
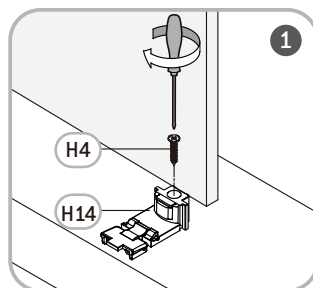
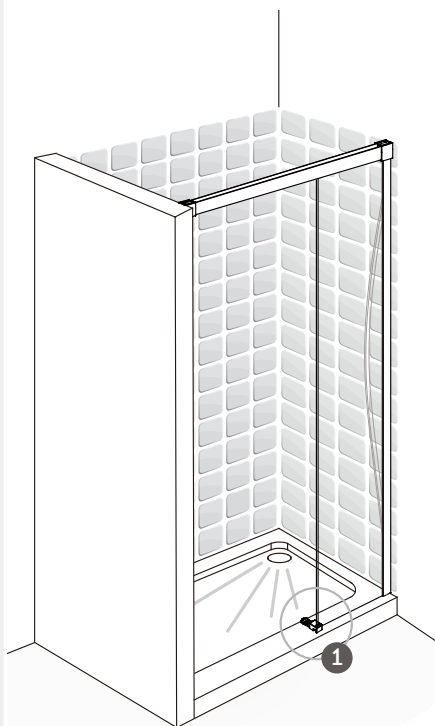

34



H14  
x1



H15  
x1

1

H15

H14

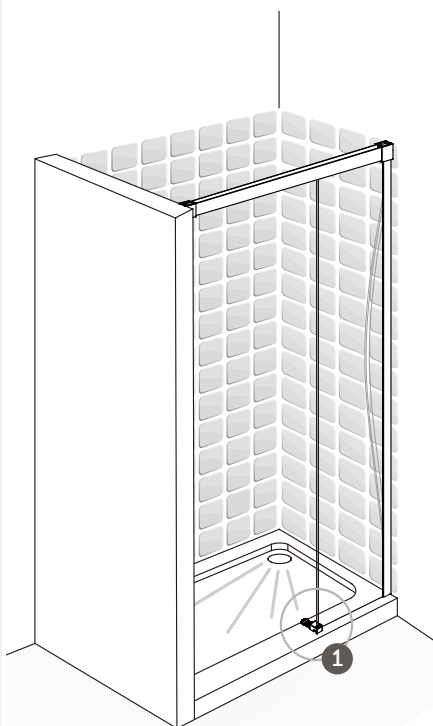
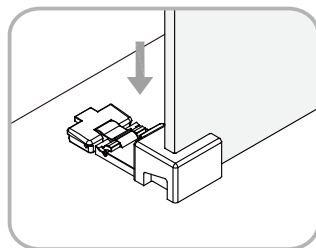
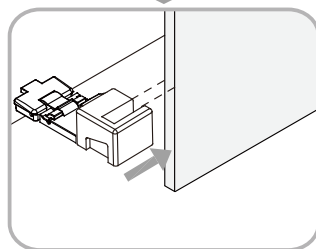
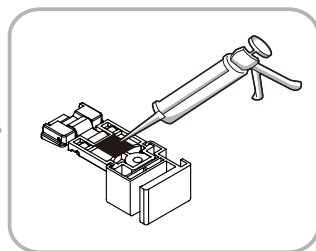

34



H1

x1



H14

x1



H16

x1

**FR** "Avertissement ! Vérifiez auprès du fabricant du receveur de douche que celui-ci peut être percé. Si ce n'est pas le cas, utilisez du silicone."

**ES** "¡Advertencia! Consulte con el fabricante del plato de la ducha si puede ser perforado. Utilice silicona en caso contrario."

**PT** "Aviso! Pergunte ao fabricante da base de chuveiro se esta pode ser perfurada. Se não for o caso, use silicone."

**IT** "Verificare con il produttore della colonna per la doccia se quest'ultima può essere forata. In caso contrario, utilizzare del silicone."

**EL** "Προειδοποίηση! Ρωτήστε τον κατασκευαστή ντους/ζεράρας εάν μπορεί να βιδωθεί. Εάν δεν γίνεται, χρησιμοποιήστε σιλικόνη."

**PL** "Ostrzeżenie! Prosimy sprawdzić u producenta brodzika, czy można w nim wiercić otwory. Jeśli nie, należy użyć silikonu."

**RU** "Предупреждение! Узнайте у производителя душевого поддона, допускается ли его сверление. В противном случае используйте силиконовый герметик."

**UA** "Увага! Зверніться до виробника душевого піддона щодо питання свердлення піддона. Якщо це неможливо, використовуйте силікон."

**RO** "Avertizare! Consultați-vă cu producătorul cădiței de duș pentru a afla dacă această poate fi găurit. Dacă nu poate fi găurită, utilizați silicon."

**EN** "Warning! Check with shower tray's maker if it can be drilled. If not, use silicon."

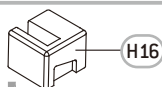

1

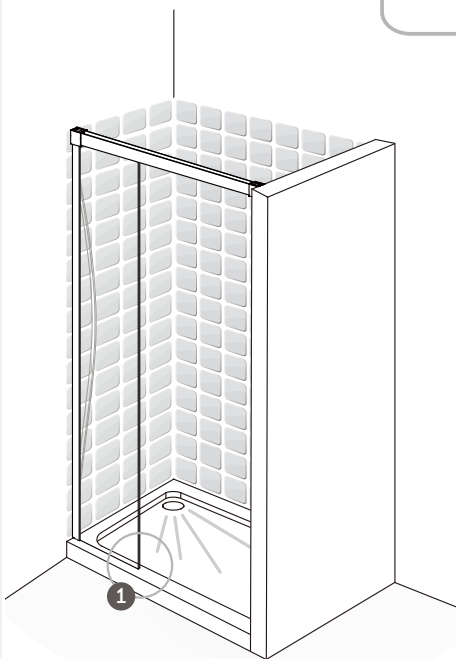
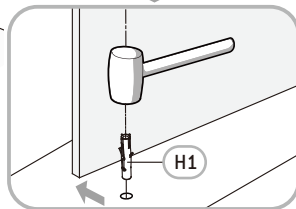
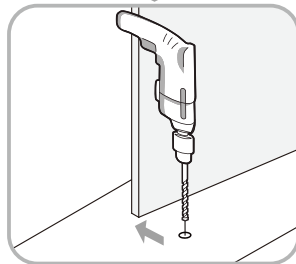
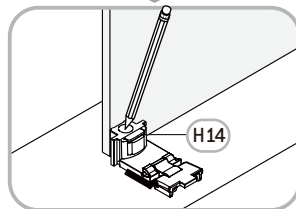
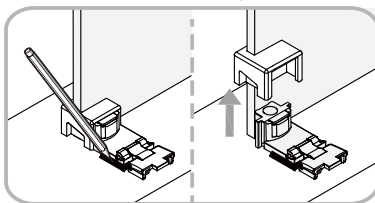
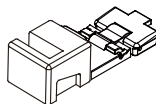
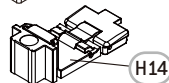



H4

x1



H14

x1



H16

x1

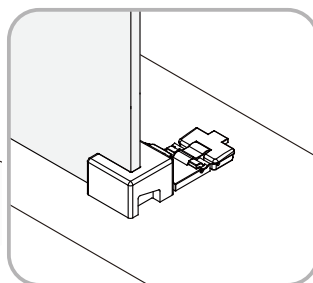
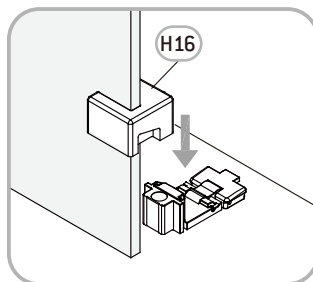
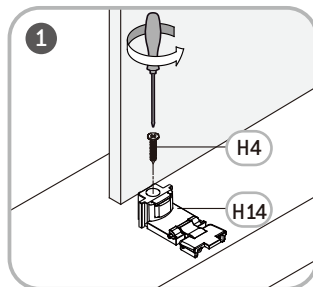
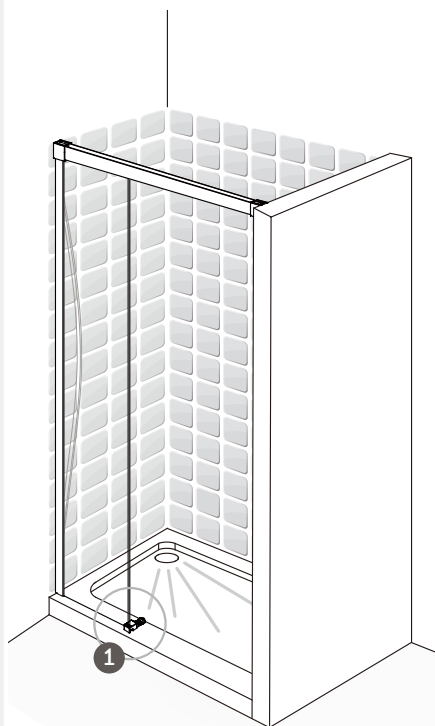

34





H14  
x1



H16  
x1

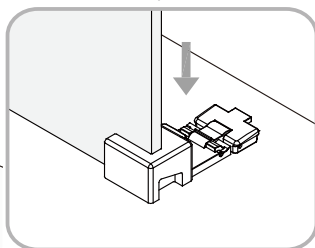
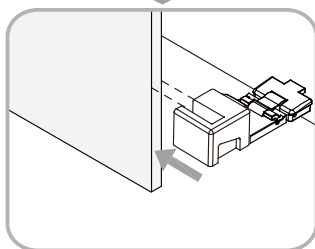
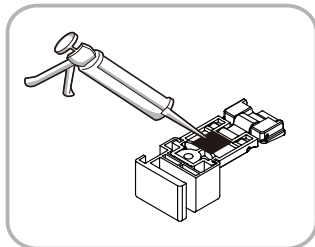
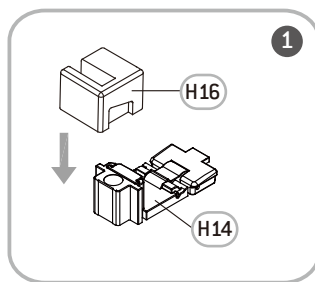
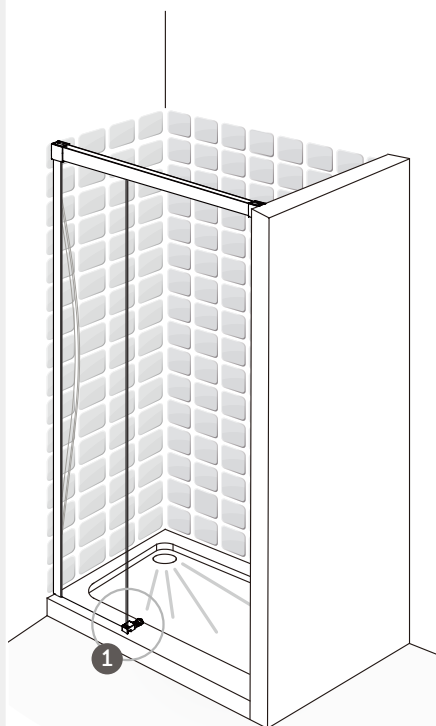

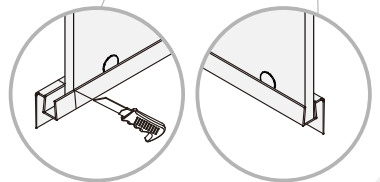
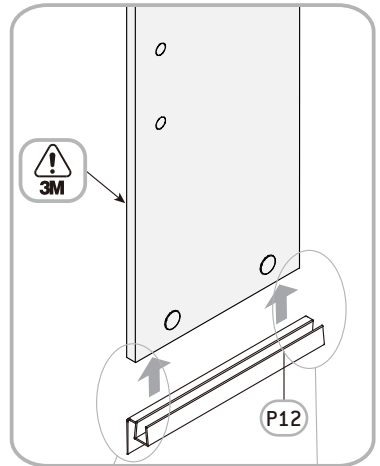
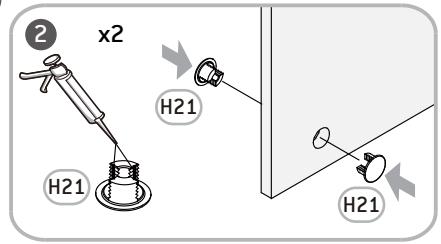
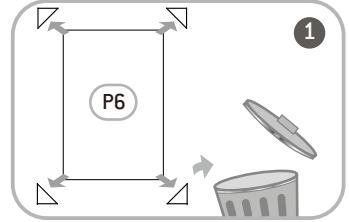
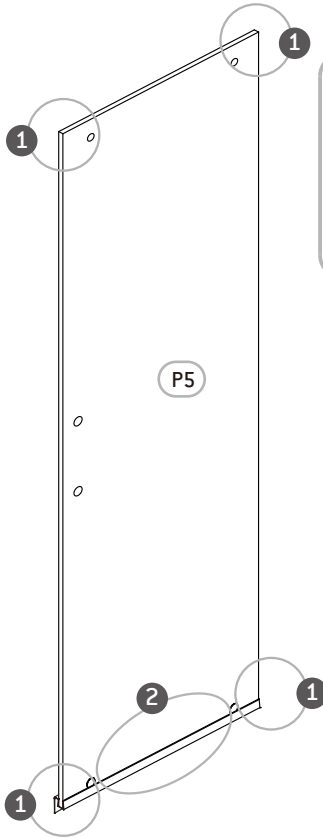
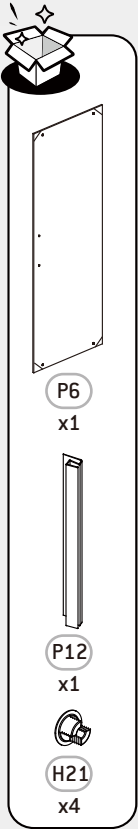

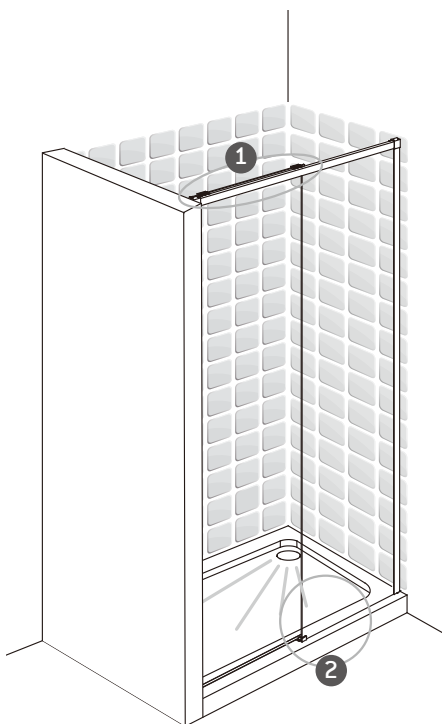
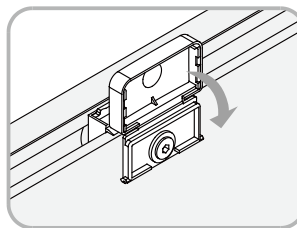
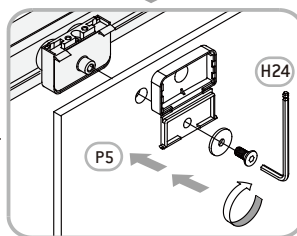
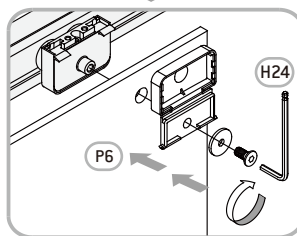
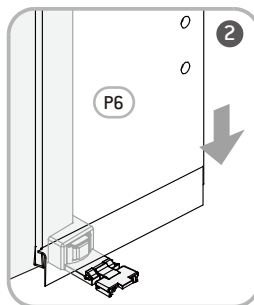
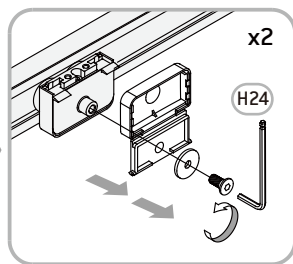
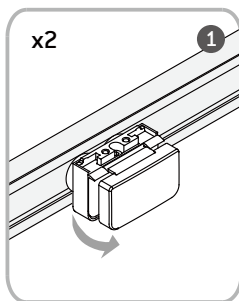
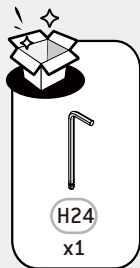

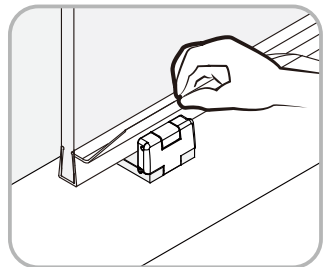
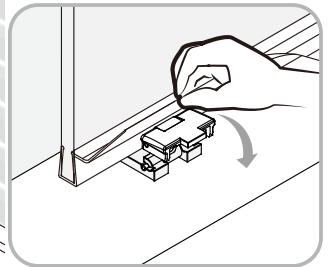
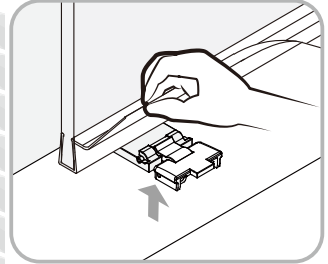
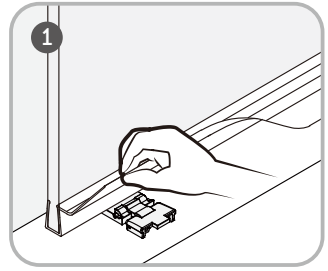
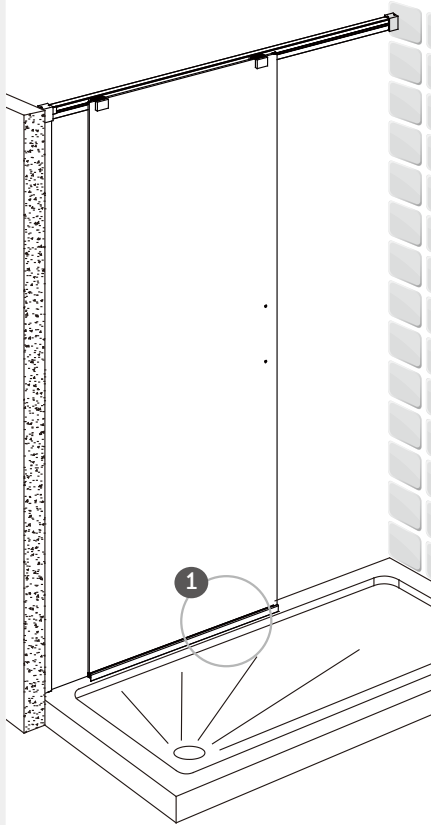

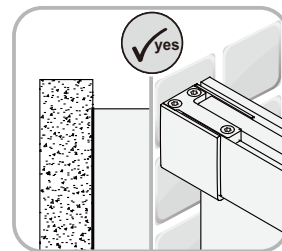
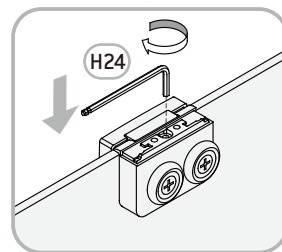
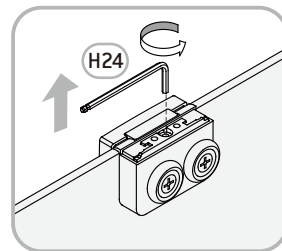
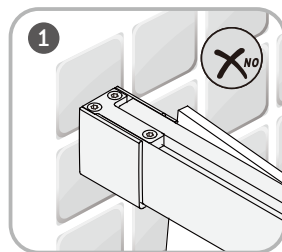
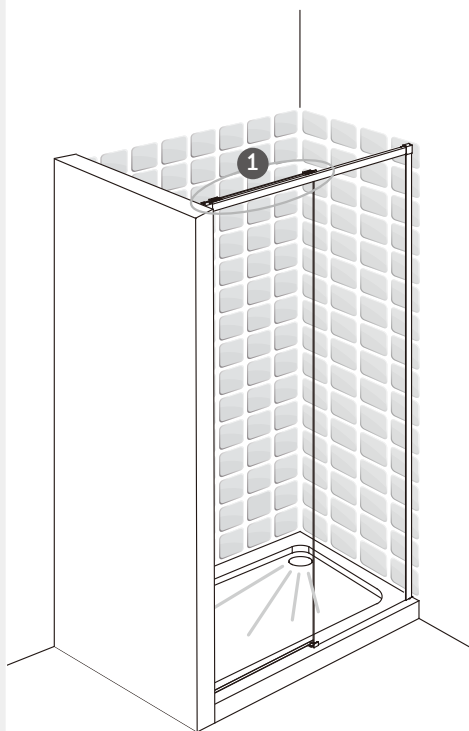
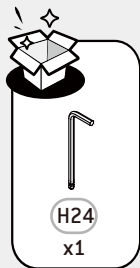

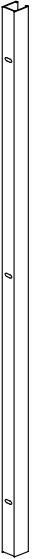

P4  
x1

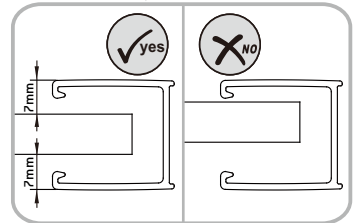
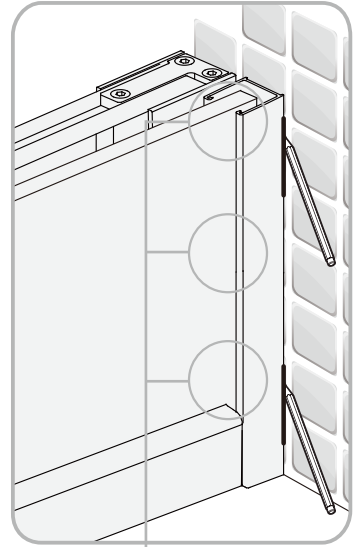
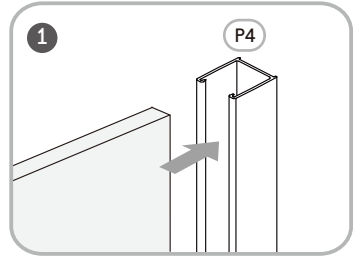
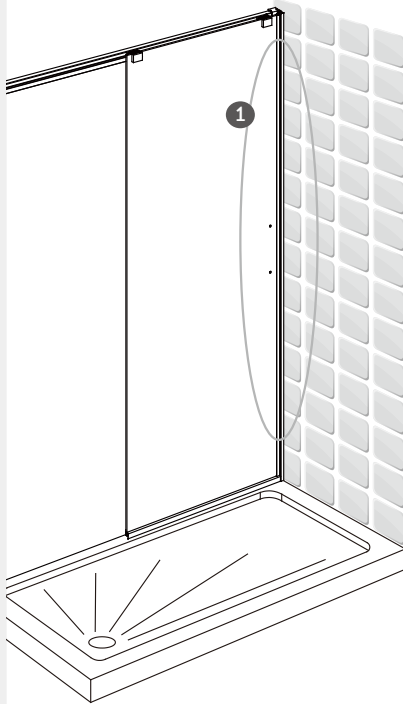



P4  
x1



H1  
x3



H3  
x3

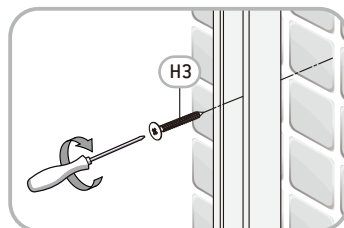
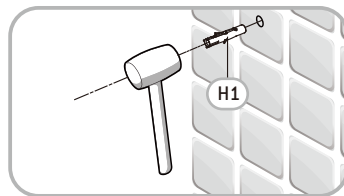
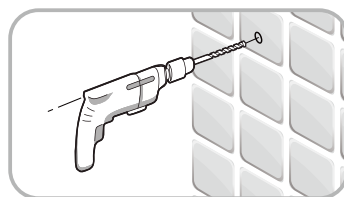
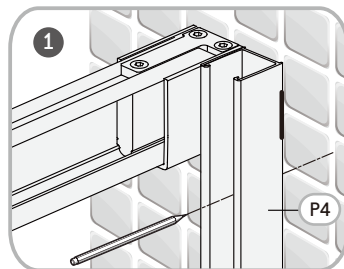
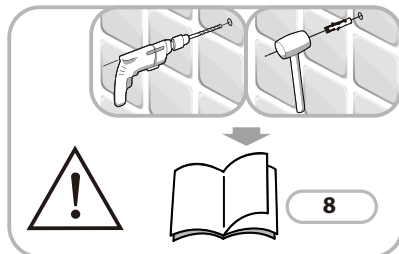
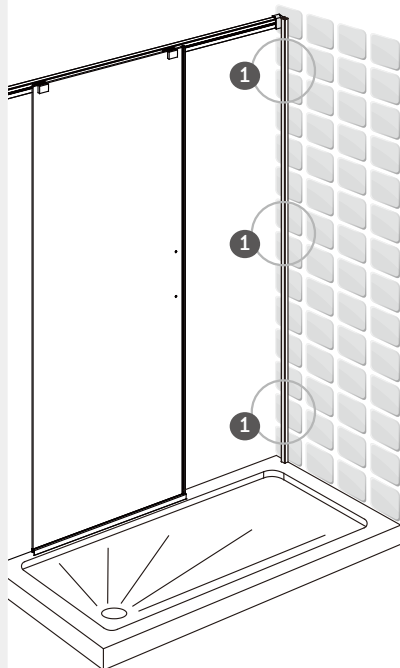



P5  
x1

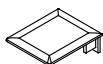

H20  
x1

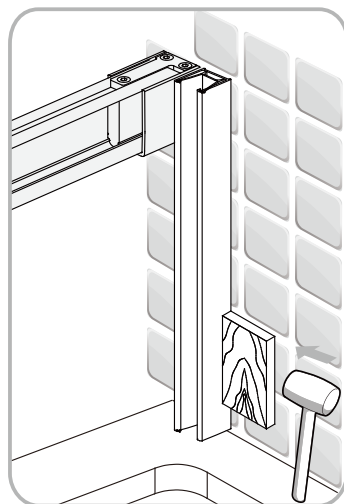
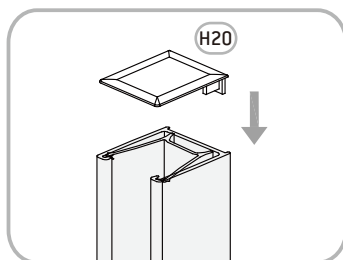
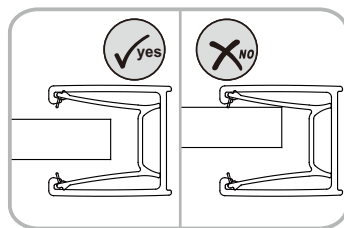
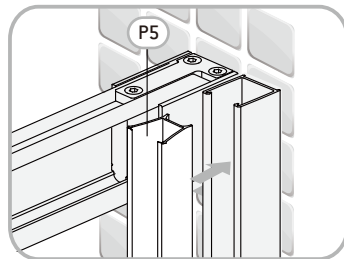
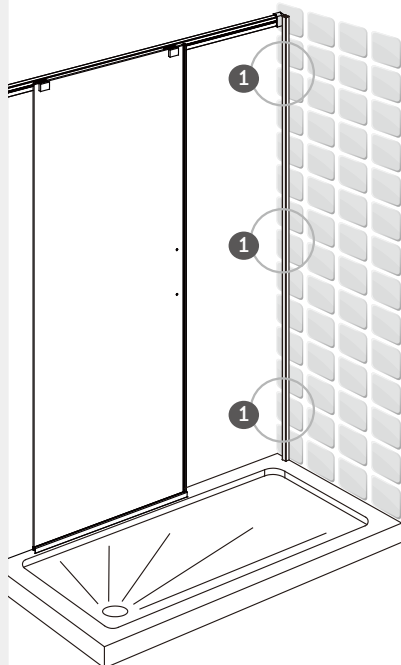
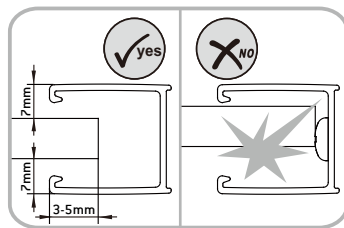
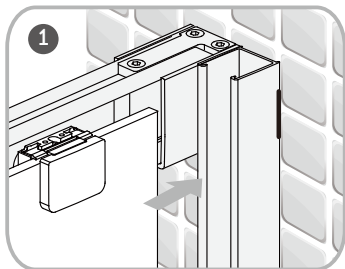



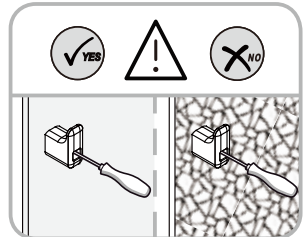
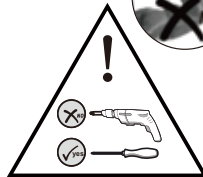
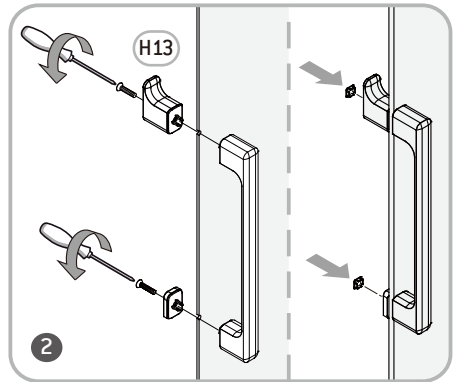
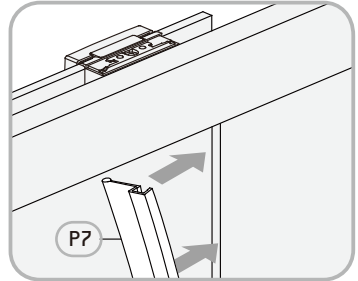
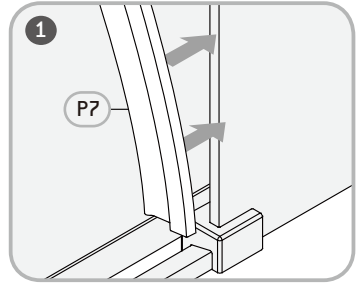
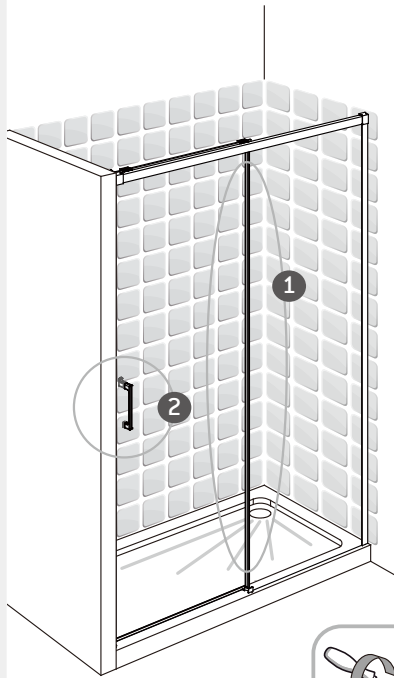
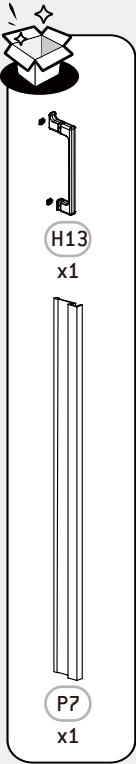



H6

x2



H12

x1

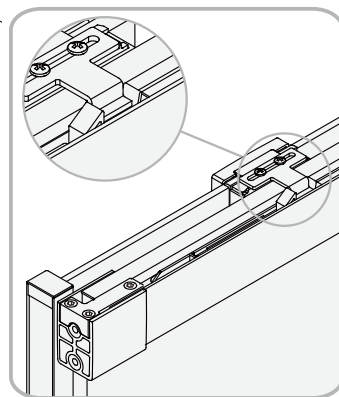
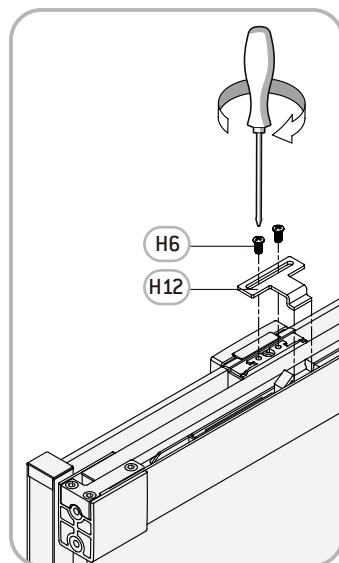
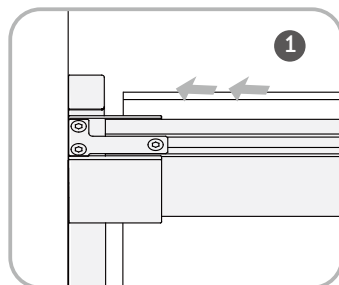
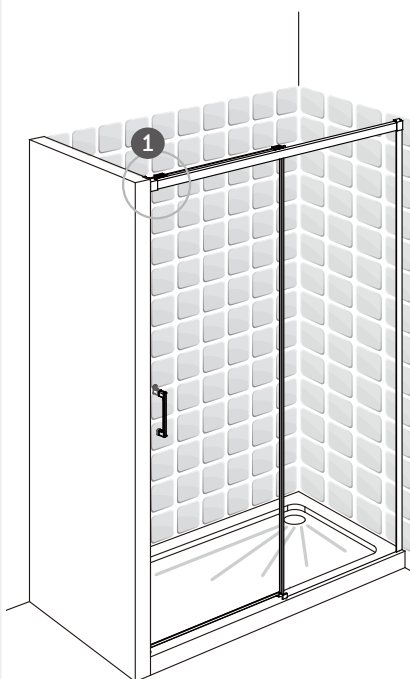

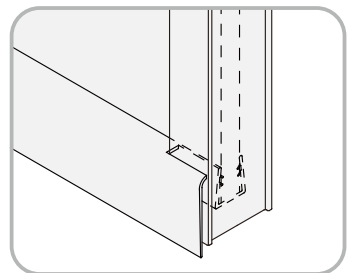
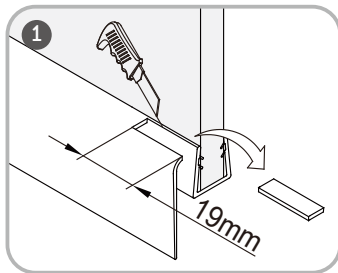
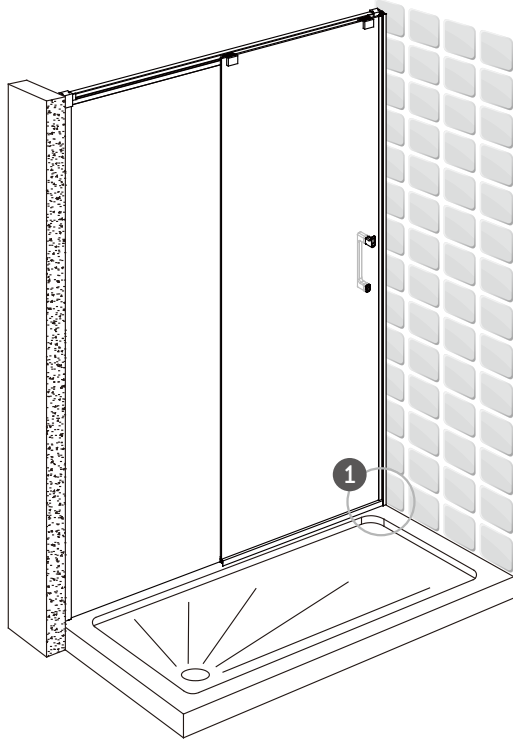



35

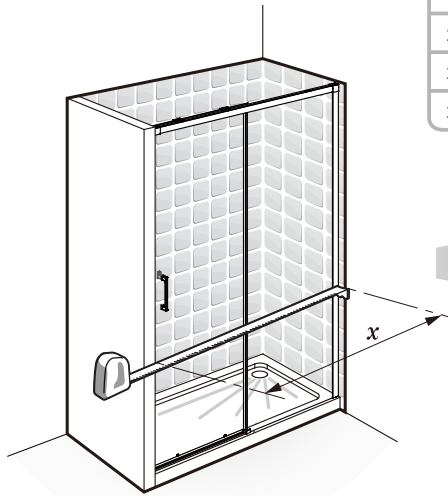

REMIX	X(mm)
1000mm	965-1005
1200mm	1165-1205
1400mm	1365-1405



46

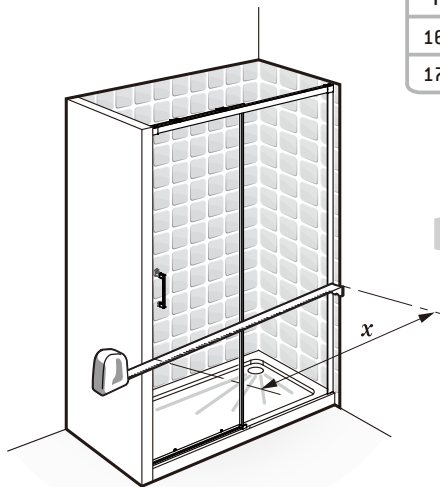

REMIX	X(mm)
1600mm	1565-1605
1700mm	1665-1705



45

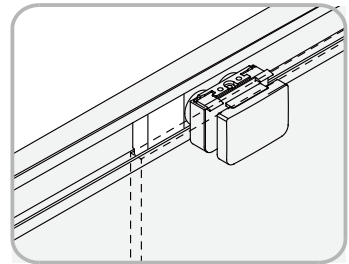
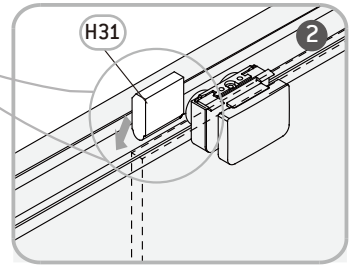
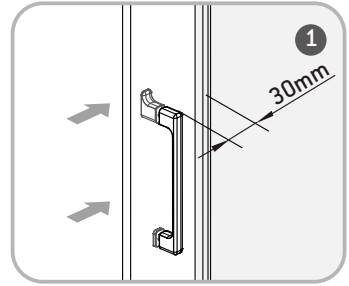
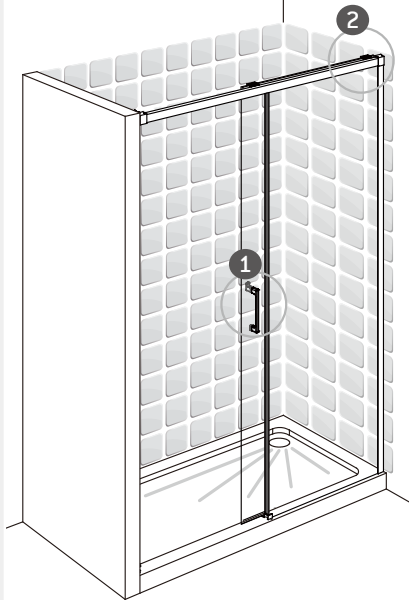
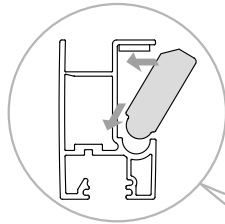
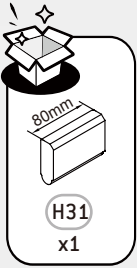



37

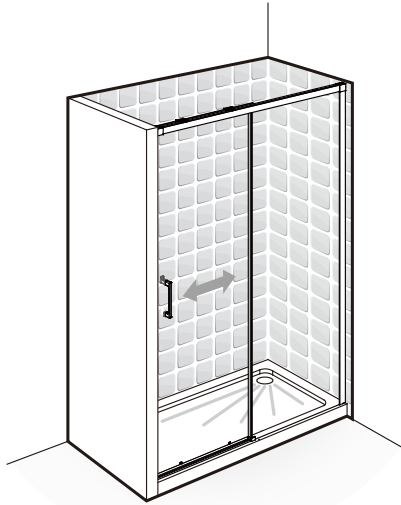

47

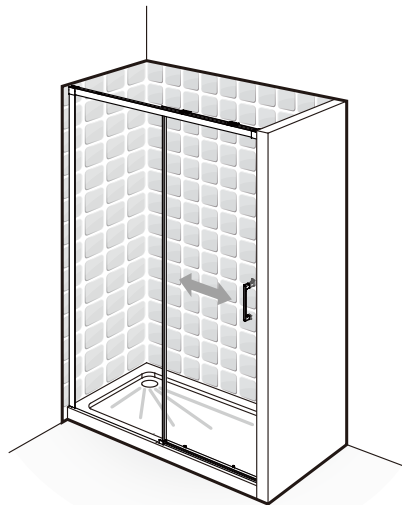

48



P11  
x1



H17  
x1

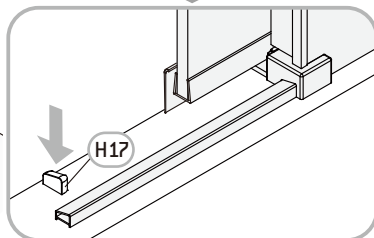
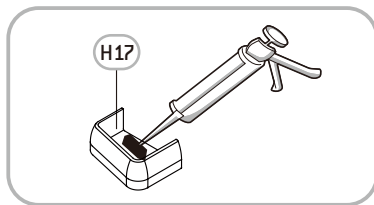
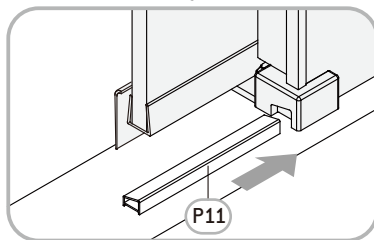
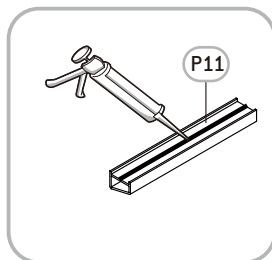
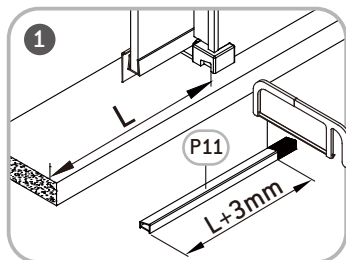
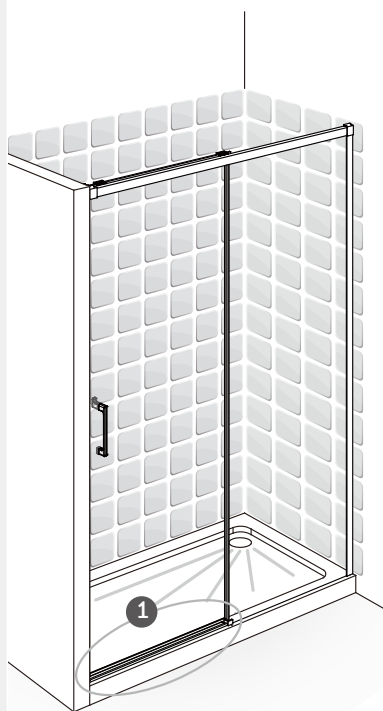



P11  
x1



H18  
x1

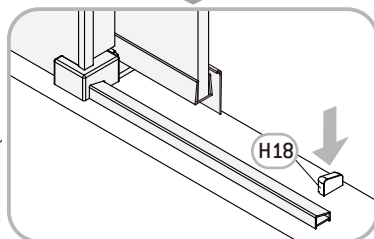
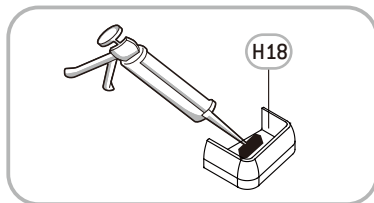
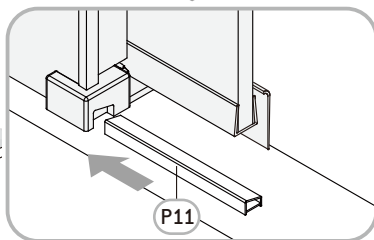
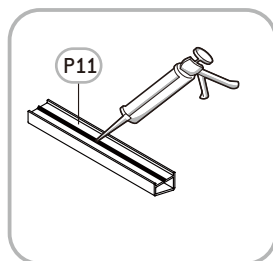
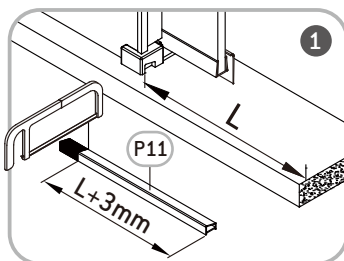
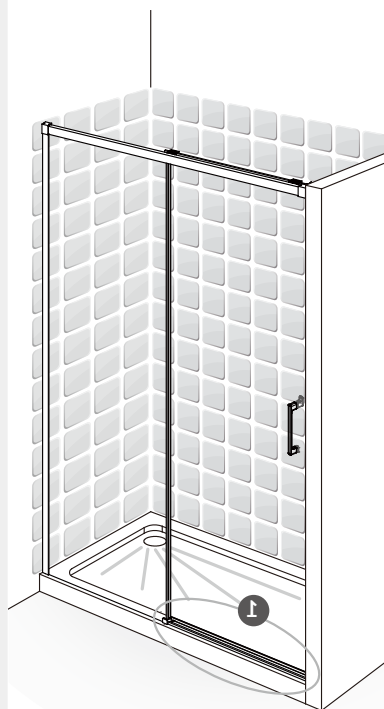



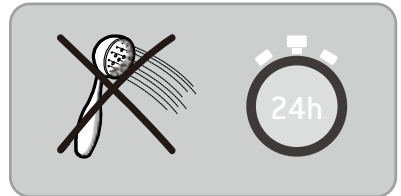
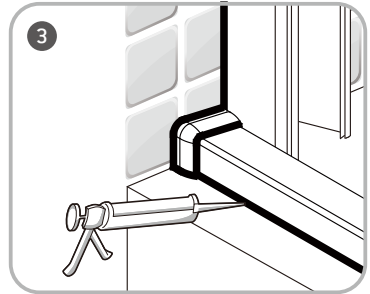
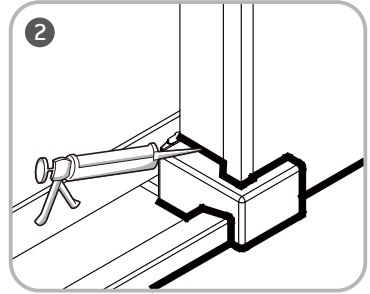
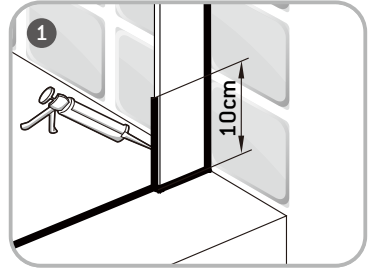
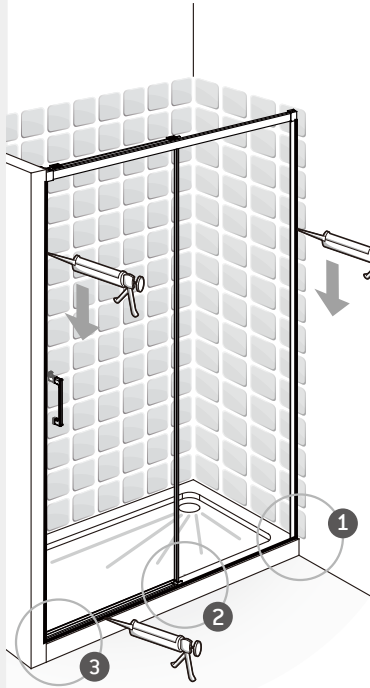



i



Eau claire / Agua limpia / Água limpa / Acqua pulita / Καθαρό νερό / Czysta woda / Чистая вода / Agua limpa /  
Чиста вода / Ara curata / таза су / Clean water



Sans solvant / Sin disolvente / Sem solventes / Senza solventi / Χωρίς διαλυτικά / Bez rozpuszczalnika / Без растворителя /  
Sem solventes / Без розчинника / Fara solvent / еріткіючі / Solvent-free

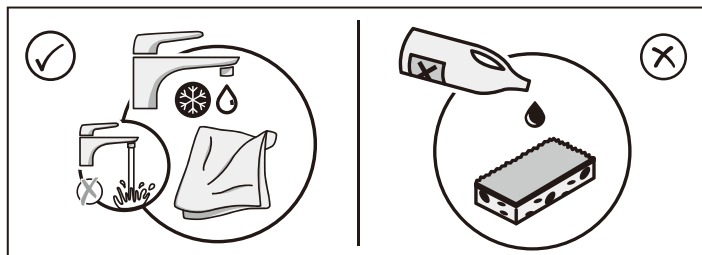
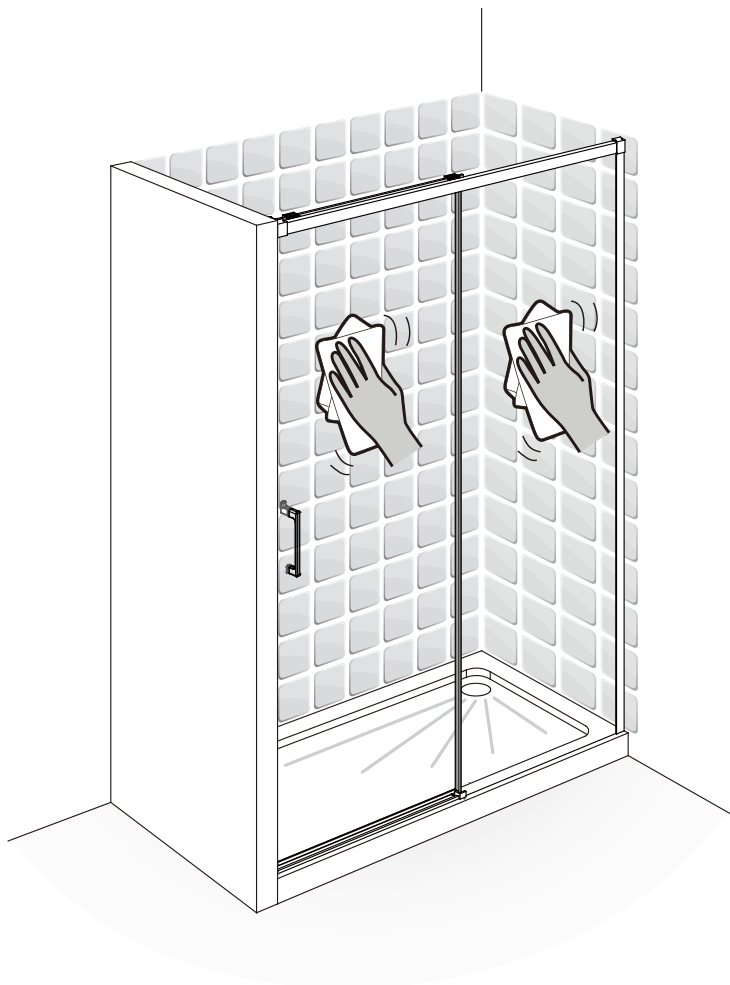



**FR**

**CE**

ADEO Services -135 Rue Sadi Carnot -  
CS 00001 59790 RONCHIN - France  
19  
EN 14428:2015+A1:2018

Code d'identification unique  
du produit type: \*\*

usage prévu: hygiène personnelle  
Nettoyable: Conforme  
Résistance à l'impact/  
Capacité de Fragmentation: Conforme  
durabilité: Conforme

DOP N ° 208993/0003/2019

**ES**

**CE**

ADEO Services -135 Rue Sadi Carnot -  
CS 00001 59790 RONCHIN - France  
19  
EN 14428:2015+A1:2018

Código de identificación  
única del producto tipo: \*\*

Uso previsto: higiene personal  
Limpiable: Conforme  
Resistencia al impacto/  
Capacidad de fragmentación: Conforme  
Durabilidad: Conforme

DOP N ° 208993/0003/2019

**PT**

**CE**

ADEO Services -135 Rue Sadi Carnot -  
CS 00001 59790 RONCHIN - France  
19  
EN 14428:2015+A1:2018

Código de identificação  
único do produto-tipo: \*\*

Utilização prevista: higiene pessoal  
Limpeza: Conforme  
Resistência ao impacto/  
Capacidade de fragmentação: Conforme  
Durabilidade: Conforme

DOP N ° 208993/0003/2019

**IT**

**CE**

ADEO Services -135 Rue Sadi Carnot -  
CS 00001 59790 RONCHIN - France  
19  
EN 14428:2015+A1:2018

Codice di identificazione  
unico del prodotto-tipo: \*\*

Uso previsto: igiene personale  
Pulibile: Conforme  
Resistenza agli urti/  
Capacità di Frammentazione: Conforme  
Durata: Conforme

DOP N ° 208993/0003/2019

**EL**

**CE**

ADEO Services -135 Rue Sadi Carnot -  
CS 00001 59790 RONCHIN - France  
19  
EN 14428:2015+A1:2018

Μοναδικός κωδικός ταυτοποίησης  
του τύπου του προϊόντος: \*\*

προβλεπόμενη χρήση: προσωπική υγιεινή  
Δυνατότητα καθαρισμού: Σύμφωνα με  
Ανοχή σε κρούση/ Ικανότητα κατάτμησης: Σύμφωνα με  
Διάρκεια: Σύμφωνα με

DOP N ° 208993/0003/2019

**PL**

**CE**

ADEO Services -135 Rue Sadi Carnot -  
CS 00001 59790 RONCHIN - France  
19  
EN 14428:2015+A1:2018

Niepowtarzalny kod  
identyfikacyjny typu wyrobu: \*\*

przeznaczenie: higiena osobista  
Możliwość czyszczenia: Zgodny  
Odporność na uderzenia/  
Rozkruszalność: Zgodny  
Trwałość: Zgodny

DOP N ° 208993/0003/2019

**RO**

**CE**

ADEO Services -135 Rue Sadi Carnot -  
CS 00001 59790 RONCHIN - France  
19  
EN 14428:2015+A1:2018

Cod unic de identificare  
a tipului de produs: \*\*

destinație: igienă personală  
Posibilitatea de curățare: Conform  
Rezistență la impact/  
Capacitate de fragmentare: Conform  
Durabilitate: Conform

DOP N ° 208993/0003/2019

**EN**

**CE**

ADEO Services -135 Rue Sadi Carnot -  
CS 00001 59790 RONCHIN - France  
19  
EN 14428:2015+A1:2018

Unique identification code  
of the product-type: \*\*

intended use: personal hygiene  
cleanability: Pass  
Impact resistance/ shatter properties: Pass  
Durability: Pass

DOP N ° 208993/0003/2019

\*\*

**FR** Reportez-vous à l'annexe.

**ES** Consulte el apéndice.

**PT** Consulte o anexo.

**IT** Consultare l'appendice.

**EL** Ανατρέξτε στο Παράρτημα.

**PL** Patrz załącznik.

**RO** Consultați anexa.

**EN** Refer to appendix.



\* Garantie 10 ans / 10 años de garantía / Garantia de 10 anos / Garanzia 10 Anni / Εγγύηση 10 ετών /  
Gwarancja 10-letnia / Гарантия 10 года / Кепілдік 10 жыл / Гарантія 10 років / Garantie 10 ani /  
10-year guarantee

Made in P.R.C. 2019

ADEO Services - 135 Rue Sadi Carnot - CS 00001  
59790 RONCHIN - France

ТОВ «Леруа Мерлен Україна»,  
вул. Полярна 17а, м. Київ 04201, Україна

LM - 18B, Building 4,2 Dajiaoting Zhongjie, Chaoyang District,  
Beijing 100022 - CHINA, P.R.C

ООО ЛЕРУА МЕРЛЕН ВОСТОК, 141031, Московская  
область, Мытищинский район, г. Мытищи,  
Осташковское шоссе, д.1, РОССИЯ

Importado e distribuído por LEROY MERLIN  
CIA BRASILEIRA DE BRICOLAGEM  
Rua Domingas Galleri Blotta, 315 - Interlagos - CEP  
04455-360 São Paulo - SP - Brazil CNPJ: 01.438.784/0001-05  
CALM (Central de Atendimento Leroy Merlin) -4020.5376 (capitais)  
e 0800.0205376 (demais regiões)

Imported by Adeo South Africa (PTY) LTD T/A Leroy Merlin  
Leroy Merlin Greenstone Store - Corner Blackrock Street  
and Stoneridge Drive, Greenstone Park Ext 2,  
Edenvale, 1610 - Johannesburg, Gauteng, South Africa

«Леруа Мерлен Қазақстан» ЖШС Қазақстан  
Республикасы, 050000, Алматы қ., Қонаев  
көшесі, 77, «ParkView» БО, бк., 07 оф.



FR/ Annexe	ES/ Apéndice	PT/ Anexo	IT/ Appendice
EL/ Παράρτημα	PL/ Załącznik	RU/ Приложение	UA/ Додаток
RO/ Anexa	EN/ Appendix		

EAN CODE	**MODEL NO.	SIZE(MM)	PROFILE
3276000693031	RE2-SL100-M-C	1000x1950	BLACK
3276000693017	RE2-SL100-S-C	1000x1950	BRIGHT CHROME
3276000693024	RE2-SL100-S-F	1000x1950	BRIGHT CHROME
3276000693062	RE2-SL120-M-C	1200x1950	BLACK
3276000693048	RE2-SL120-S-C	1200x1950	BRIGHT CHROME
3276000693055	RE2-SL120-S-F	1200x1950	BRIGHT CHROME
3276000693109	RE2-SL140-M-C	1400x1950	BLACK
3276000693086	RE2-SL140-S-C	1400x1950	BRIGHT CHROME
3276000693093	RE2-SL140-S-F	1400x1950	BRIGHT CHROME
3276000693208	RE2-SL160-M-C	1600x1950	BLACK
3276000693147	RE2-SL160-S-C	1600x1950	BRIGHT CHROME
3276000693154	RE2-SL160-S-F	1600x1950	BRIGHT CHROME
3276000693239	RE2-SL170-M-C	1700x1950	BLACK
3276000693215	RE2-SL170-S-C	1700x1950	BRIGHT CHROME
3276000693222	RE2-SL170-S-F	1700x1950	BRIGHT CHROME