

max. 45°

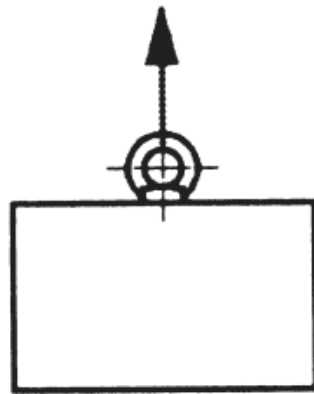

WLL

140 kg

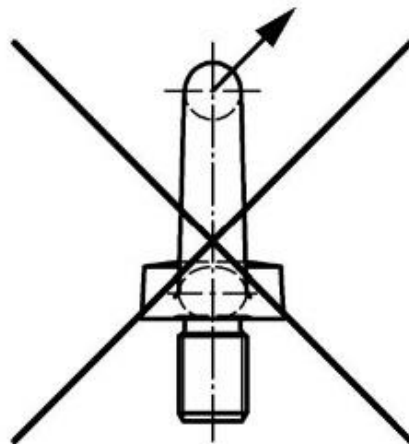
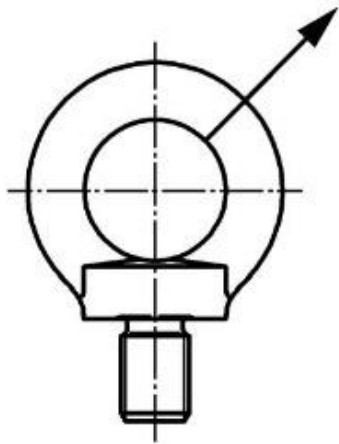
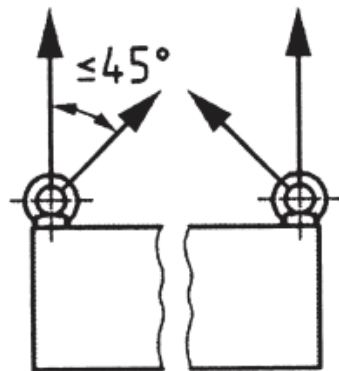

$\leq 45^\circ$

100 kg

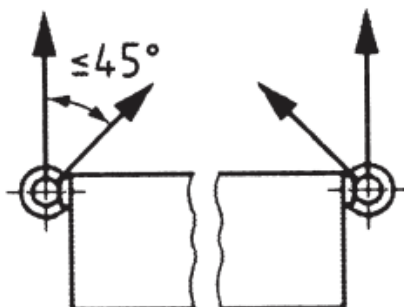

$\leq 45^\circ$

70 kg