

max. 45°

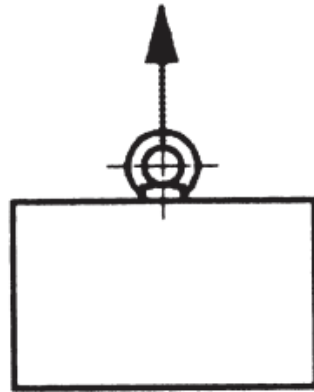

WLL

**230 kg**

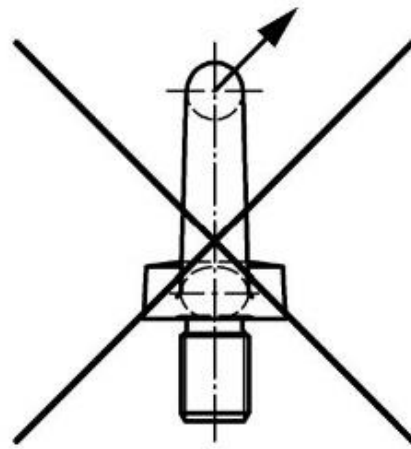
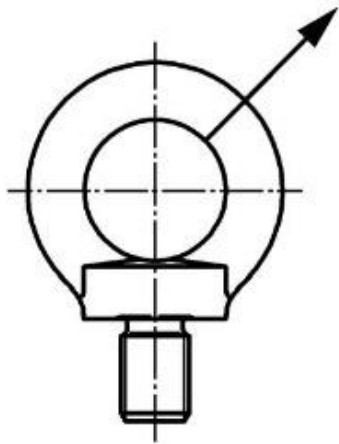
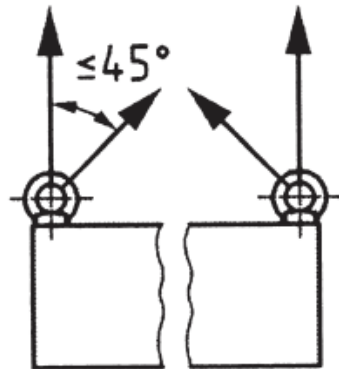

$\leq 45^\circ$

**170 kg**

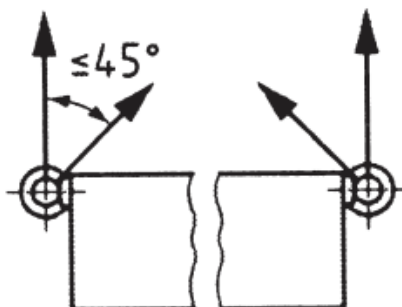

$\leq 45^\circ$

**115 kg**