

FR: Montage / ES: Montaje / PT: Montagem / IT: Montaggio / EL: Συναρμολόγηση /
PL: Montaż / RO: Montaj / BR: Montagem / EN: Assembly

1

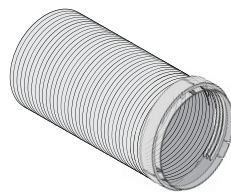

2

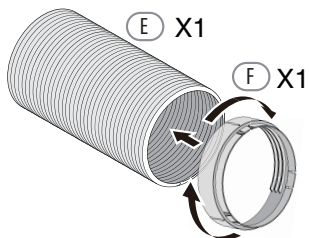
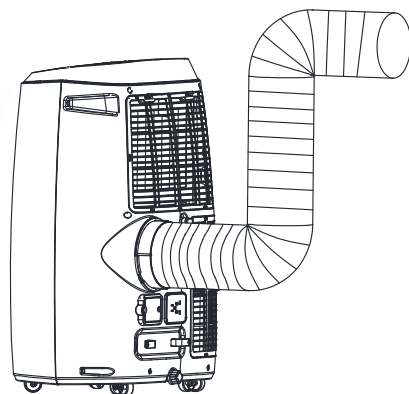
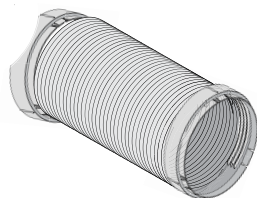

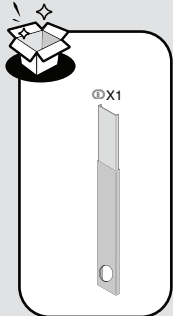

3

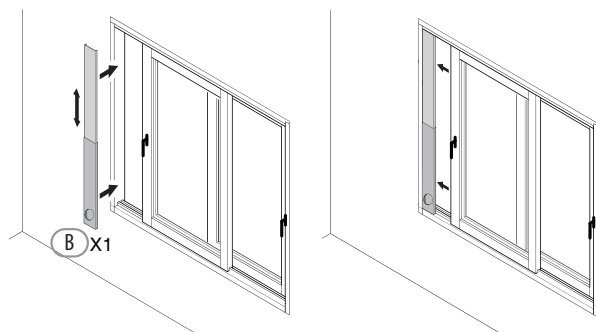

4

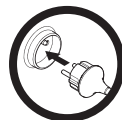
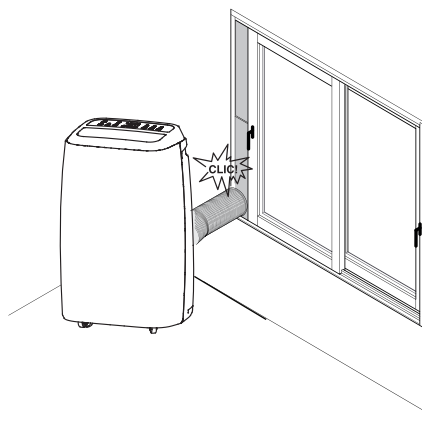

220-240V



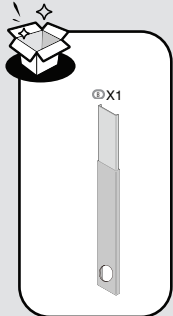

- FR: Un trou de 16.5 cm de diamètre doit être percé à une hauteur comprise entre 35 cm et 100 cm.
- ES: Se debe realizar un agujero de 16.5 cm de diámetro a una altura incluida entre 35 cm y 100 cm.
- PT: Um orifício de 16.5 cm de diâmetro deve ser perfurado a uma altura entre 35 cm e 100 cm.
- IT: Un foro dal diametro di 16.5 cm deve essere creato ad un'altezza compresa tra i 35 cm ed i 100 cm.
- EL: Πρέπει να δημιουργηθεί μία τρύπα με διάμετρο 16.5cm και ύψος μεταξύ 35cm και 100cm.
- PL: Należy wywiercić otwór o średnicy 16.5 cm na wysokości od 35 cm do 100 cm.
- RO: Diametrul de 16.5 cm trebuie creat cu o înălțime cuprinsă între 35cm și 100cm.
- RU: Отверстие диаметром 16.5 см должно быть создано при высоте от 35 см до 100 см.
- UA: Отвір діаметром 16.5 см має бути створений при висоті від 35 см до 100 см.
- EN: 16.5 cm diameter hole must be created with a height between 35 cm and 100 cm.

5

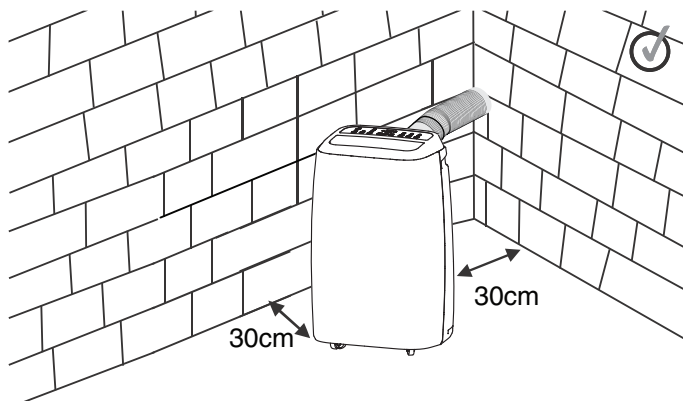



FR: Utilisation / ES: Utilización / PT: Utilização / IT: Uso / EL: Χρήση /
PL: Użytkowanie / RO: Utilizare / EN: Use

1

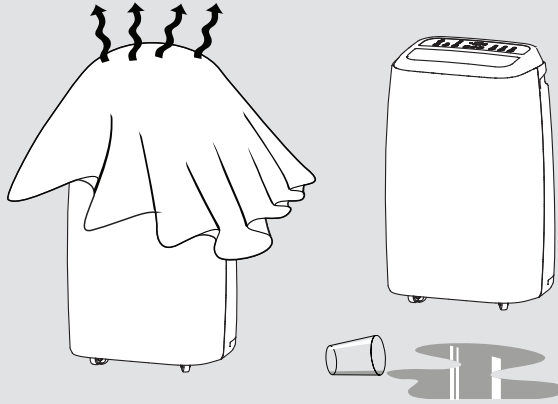

2

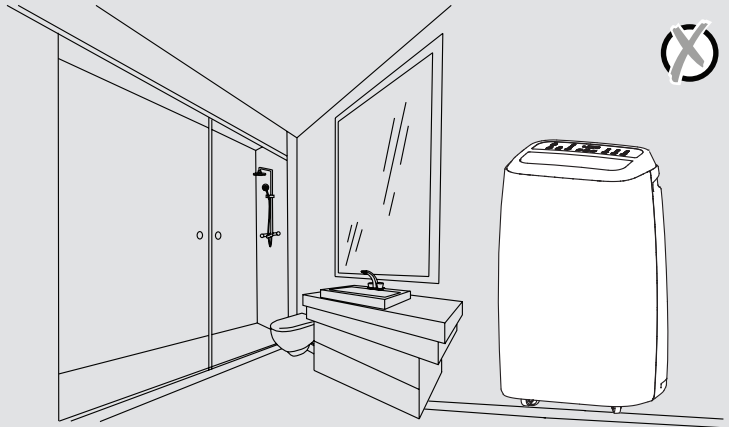

3

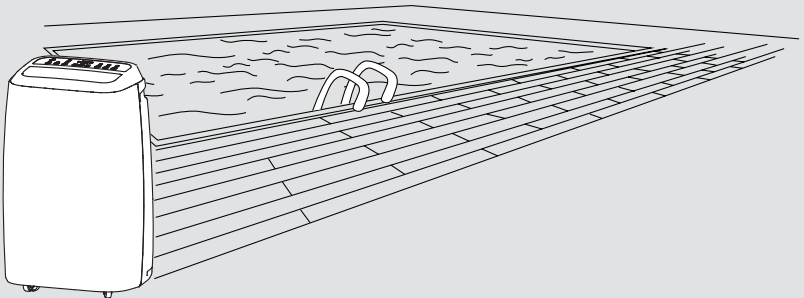



4

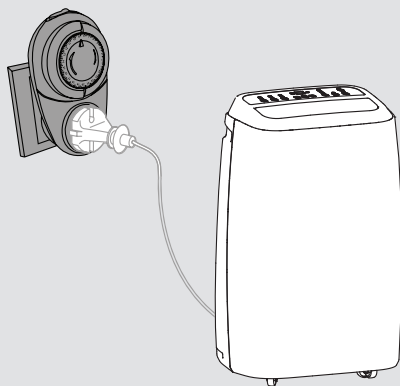

5

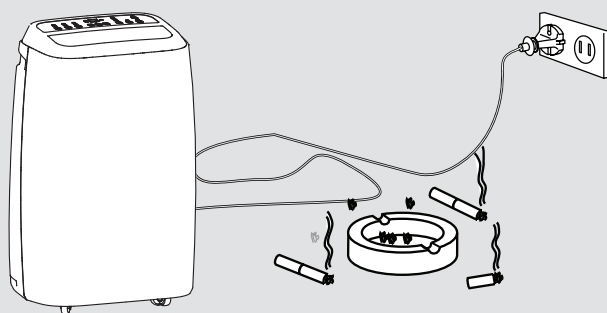



6

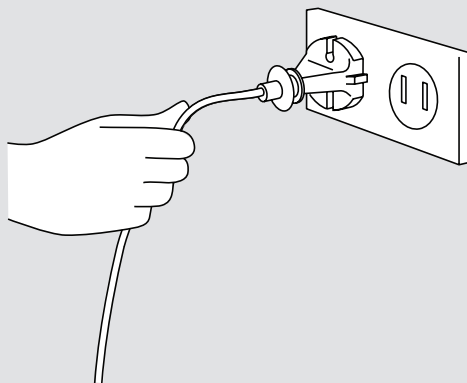

7

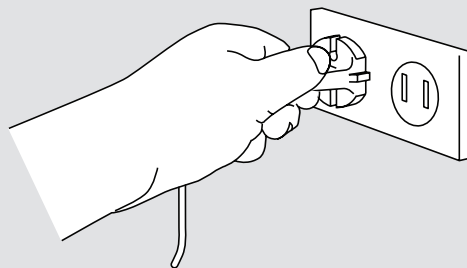



FR: Utilisation / ES: Utilización / PT: Utilização / IT: Uso / EL: Χρήση /
PL: Użytkowanie / RO: Utilizare / EN: Use

1

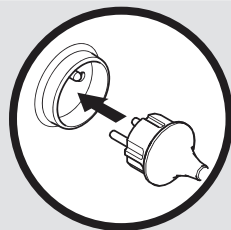
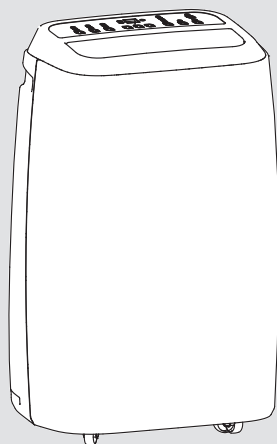

2

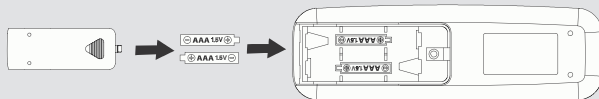



3

POWER POWER

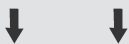
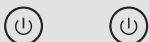

ON OFF

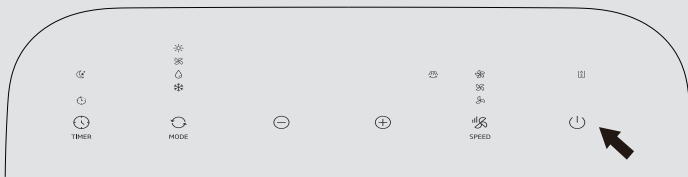
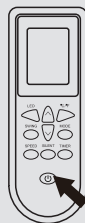

4

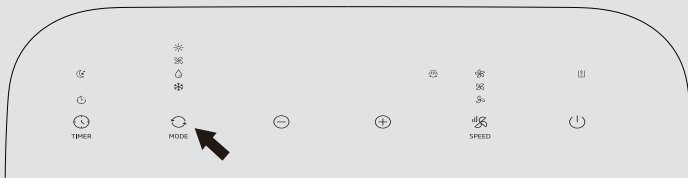

MODE

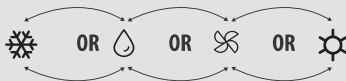



5

MODE



OR



(16-31°C)

SPEED

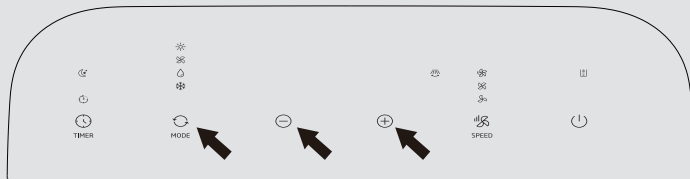

6

MODE



SPEED

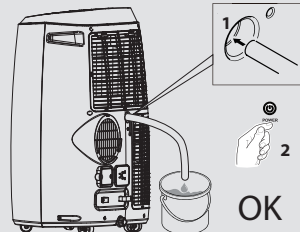
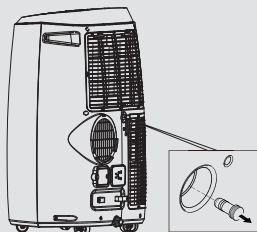
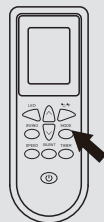



7

TIMER



UP / DOWN



1~24 H

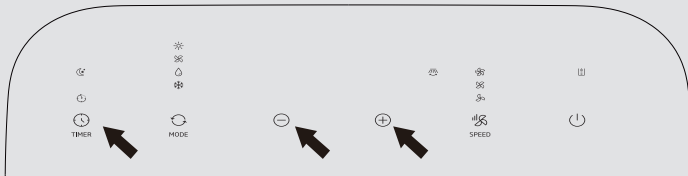

8

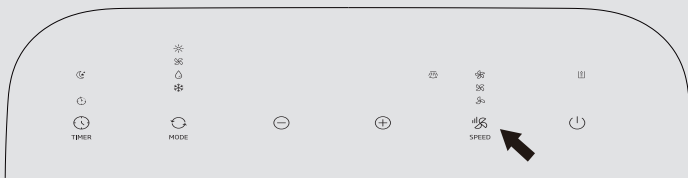

SPEED



9



SILENT





SWING

10

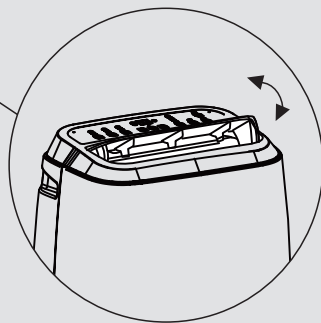
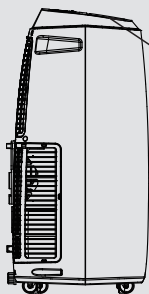



FR: Entretien / ES: Mantenimiento / PT: Manutenção / IT: Manutenzione /
EL: Συντήρηση / PL: Konserwacja / RO: Întreținere / EN: Maintenance

1

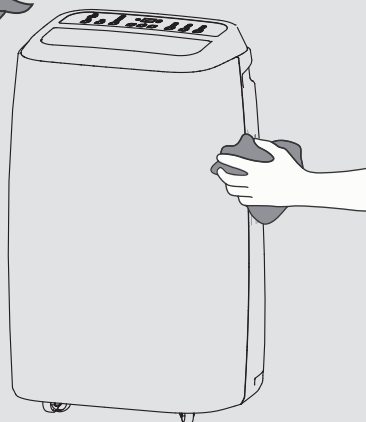

2

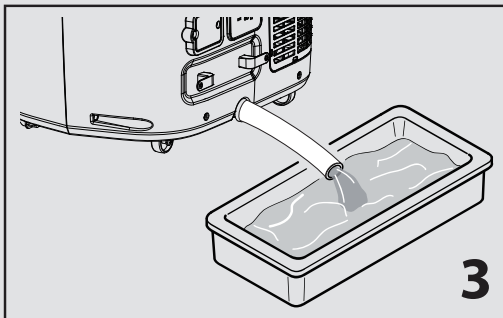
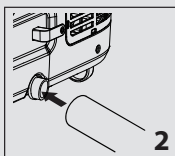
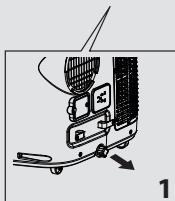
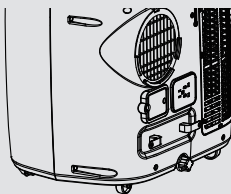



3

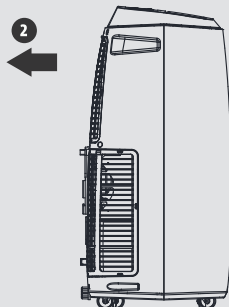

4

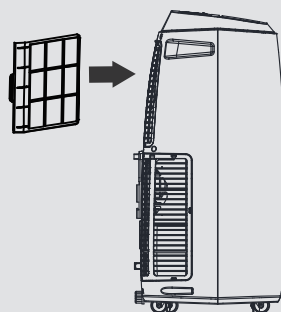
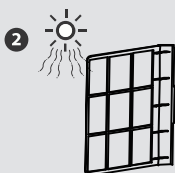
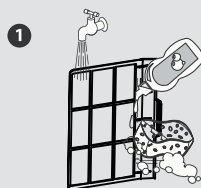

5

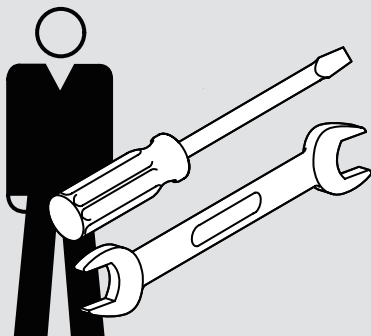



FR: Hivernage / ES: Durante el invierno / PT: Preparação para o inverno /
IT: Rimessaggio / EL: Αποθήκευση το χειμώνα / PL: Przechowywanie /
RO: Păstrare pe perioada iernii / EN: Winter storage

1

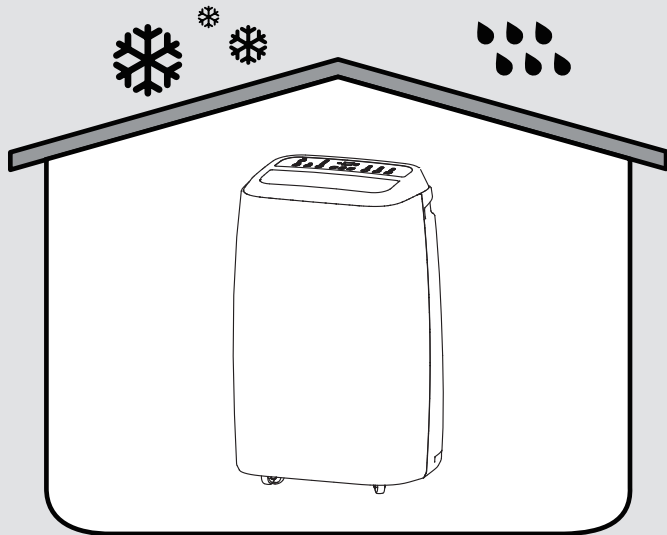

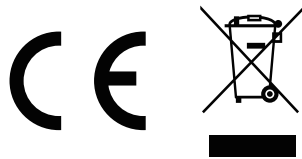

Made in China

* Garantie 5 ans / 5 años de garantía / Garantia de 5 años / Garanzia 5 Anni / Εγγύηση 5 ετών /
Gwarancja 5-letnia / Garantje 5ani /5-year guarantee

ADEO Services - 135 Rue Sadi Carnot - CS 00001
59790 RONCHIN - France

