

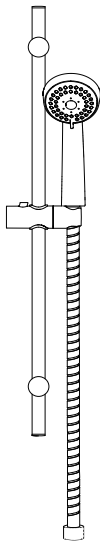

EDY



EAN CODE :3276000698364

FR Manuel d'Instructions

ES Manual de Instrucciones

PT Manual de Instruções

IT Manuale di Istruzioni

EL Εγχειρίδιο Οδηγιών

PL Instrukcja Obsługi

RU Руководства по
Эксплуатации

KZ Пайдаланушы Нұсқаулығы

UA Інструкція з Експлуатації

RO Manual de Instrucțiuni

BR Manual de Instruções

EN Instructions Manual



A1



A2



B



C1

C2

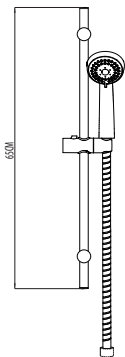

650



D

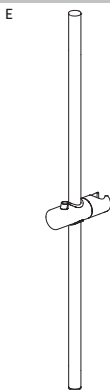

E

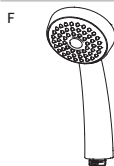

F

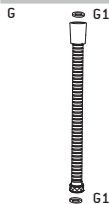

G

G1

G1



H

0 1 2 3 4 5 6 7 8 cm

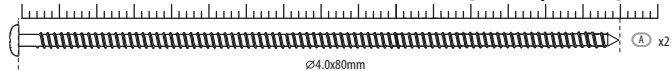

Ø4.0x80mm

(A) x2

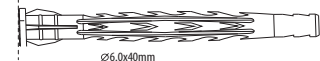

Ø6.0x40mm

(B) x2



PH



Ø6mm





Eau claire / Agua limpia / Água limpa / Acqua pulita / Καθαρό νερό / Czysta woda / Чистая вода / Água limpa /
Чиста вода / Apa curata / таза су / Clean water



Sans solvant / Sin disolvente / Sem solventes / Senza solventi / Χωρίς διαλυτικά / Bez rozpuszczalnika / Без растворителя /
Sem solventes/ Без розчинника / Fara solvent / еріткішсіз/ Solvent-free



FR: Préparation / ES: Preparación / PT: Preparação / IT: Preparazione / EL: Προετοιμασία /
PL: Przygotowanie / RU: Подготовка / KZ: Дайындау / UA: Підготування / RO: Pregătire / BR: Preparação /
EN: Preparation



4



FR: Montage / ES: Montaje / PT: Montagem / IT: Montaggio / EL: Συναρμολόγηση /
PL: Montaż / RU: Сборка / KZ: Монтаждау / UA: Збірка / RO: Montaj / BR: Montagem /
EN: Assembly



5 → 8



FR: Utilisation eau chaude-eau froide/ ES: Utilización agua caliente-agua fría/
PT: Utilização água quente-água fria/ IT: Uso acqua calda-acqua fredda/ EL: Χρήση ζεστού-κρύου νερού/
PL: Użytkowanie zimnej wody-gorącej wody/ RU: Використання гарячої води/
KZ: Суық және ыстық суды қолдану/ UA: води - холодної води/ RO: Utilizare apă caldă-apă rece/
BR: Uso de água quente e fria/ EN: Using hot and cold water



9 → 10



FR: Montage / ES: Montaje / PT: Montagem / IT: Montaggio / EL: Συναρμολόγηση /
PL: Montaż / RU: Сборка / KZ: Монтаждау / UA: Збірка / RO: Montaj / BR: Montagem /
EN: Assembly

1

A1

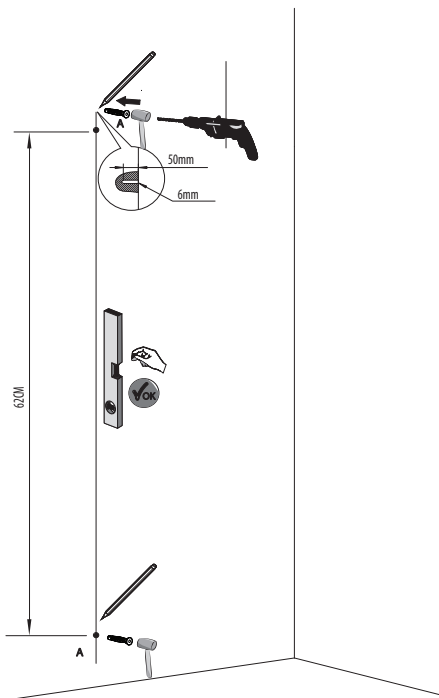



2



B



A2



FR: Entretoise de 5 mm / ES: Espaciador de 5 mm / PT: Espaçador de 5 mm /
IT: Distanziatore da 5 mm / EL: Αποστάτες 5 χιλιοστών /
PL: Dystans (Podkładka) 5 mm / RU: Прокладка 5 мм /
KZ: 5 мм аралық төсем / UA: Прокладка 5 мм / RO: Distajter 5 mm /
BR: Espaçador de 5 mm / EN: 5 mm spacer



3



E



B



A2



H

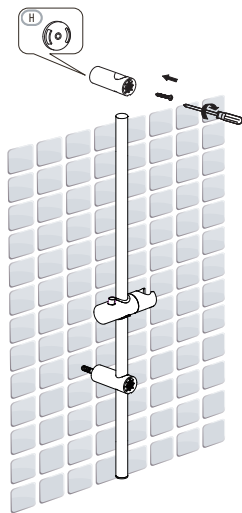
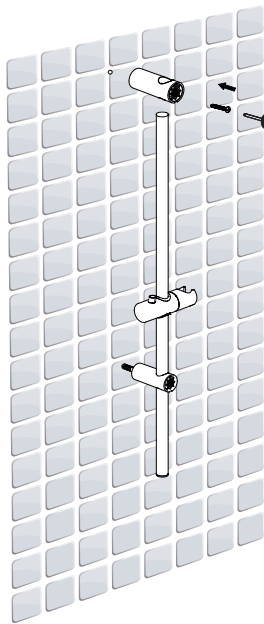



4

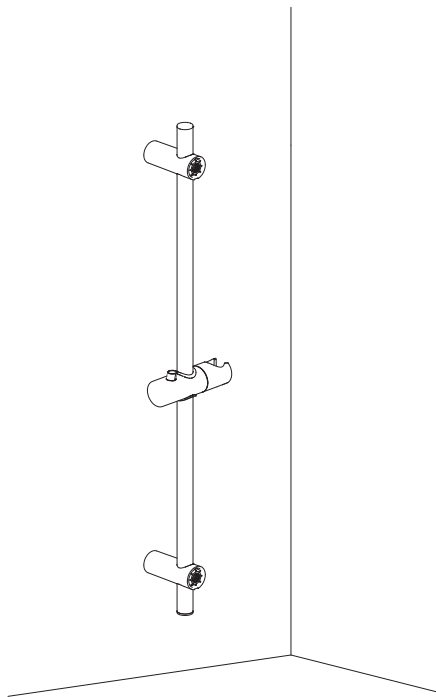
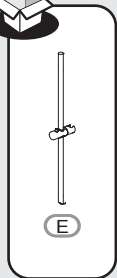

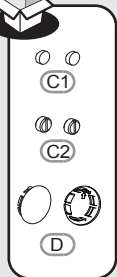

5

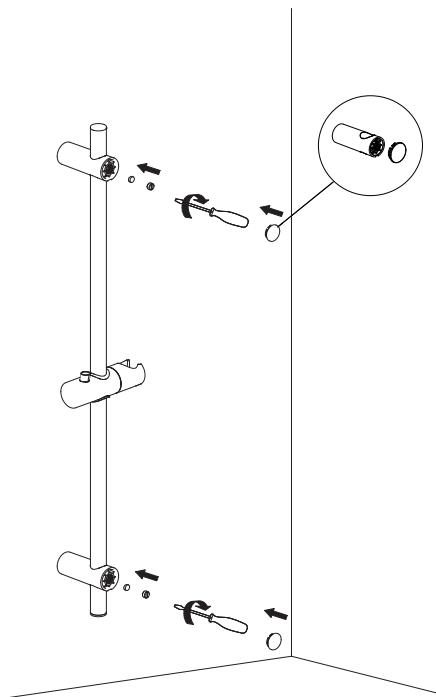
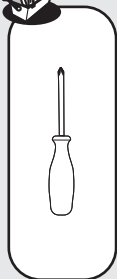

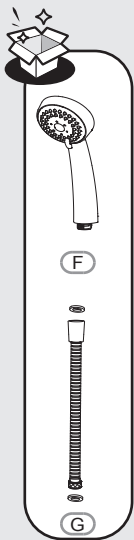

6

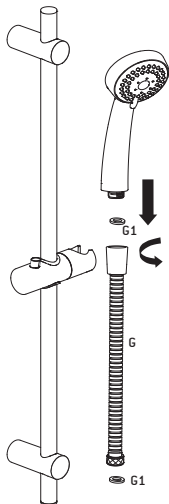



7

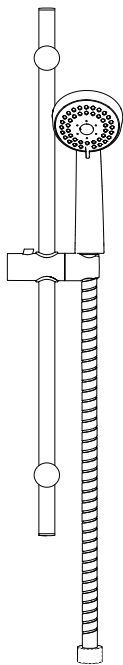



Eau claire / Agua limpia / Água limpa / Acqua pulita / Καθαρό νερό / Czysta woda / Чистая вода / Água limpa /
Чиста вода / Ara curata / таза су / Clean water



Sans solvant / Sin disolvente / Sem solventes / Senza solventi / Χωρίς διαλυτικά / Bez rozpuszczalnika / Без растворителя /
Sem solventes/ Без розчинника / Fara solvent / еріткішсіз/ Solvent-free

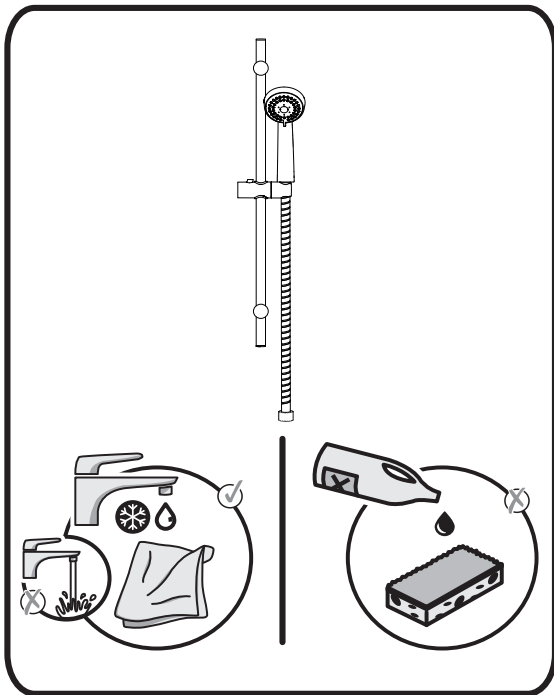



- FR** Attestation de conformité sanitaire
- ES** Certificado de conformidad sanitaria.
- PT** Atestado de conformidade sanitária.
- IT** certificato di conformità sanitaria.
- EL** Βεβαίωση υγειονομικής συμμόρφωσης.
- PL** Certyfikat zgodności sanitarnej.
- RU** Декларация о соответствии санитарным нормам
- KZ** Санитарлық талаптарға сәйкестік декларациясы
- UA** Декларація про відповідність санітарним нормам
- RO** Atestat de conformitate sanitară
- BR** Certificado de conformidade sanitária.
- EN** Declaration of sanitary conformity.



* Garantie 5 ans / 5 años de garantía / Garantia de 5 anos / Garanzia 5 Anni / Εγγύηση 5 ετών /
Gwarancja 5-letnia / Гарантия 5 года / Көпіңдік 5 жыл / Гарантія 5 років / Garantie 5 ani /
5-year guarantee



Made in P.R.C. 2019

ADEO Services - 135 Rue Sadi Carnot - CS 00001
59790 RONCHIN - France

UA ТОВ «Леруа Мерлен Україна»,
вул. Полтавна 17а, м. Київ 04201, Україна

ZH LM - 188, Building 4,2 Dajiaozong Zhongjie, Chaoyang District,
Beijing 100022 - CHINA, P.R.C

RU ООО ЛЕРУА МЕРЛЕН ВОСТОК, 141031, Московская
область, Мытищинский район, г. Мытищи,
Осташковское шоссе, д.1, РОССИЯ

BR Importado e distribuído por LEROY MERLIN
CIA BRASILEIRA DE BRICÓLAGEM
Rua Domingas Galleri Blotta, 315 - Interlagos - CEP
04455-360 São Paulo - SP - Brazil CNPJ: 01.438.784/0001-05
CALM (Central de Atendimento Leroy Merlin) -4020.5376 (capitals)
e 0800.0205376 (demais regiões)

SA Imported by Adeo South Africa (PTY) LTD T/A Leroy Merlin
Leroy Merlin Greenstone Store - Corner Blackrock Street
and Stoneridge Drive, Greenstone Park Exit 2,
Edenvale, 1610 - Johannesburg, Gauteng, South Africa

KZ «Леруа Мерлен Қазақстан» ЖШС Қазақстан
Республикасы, 050000, Алматы қ., Қонаев
көшесі, 77, «ParkView» БО, 6к., 07 оф.



此页不印刷A6样式 骑马钉 12P

