

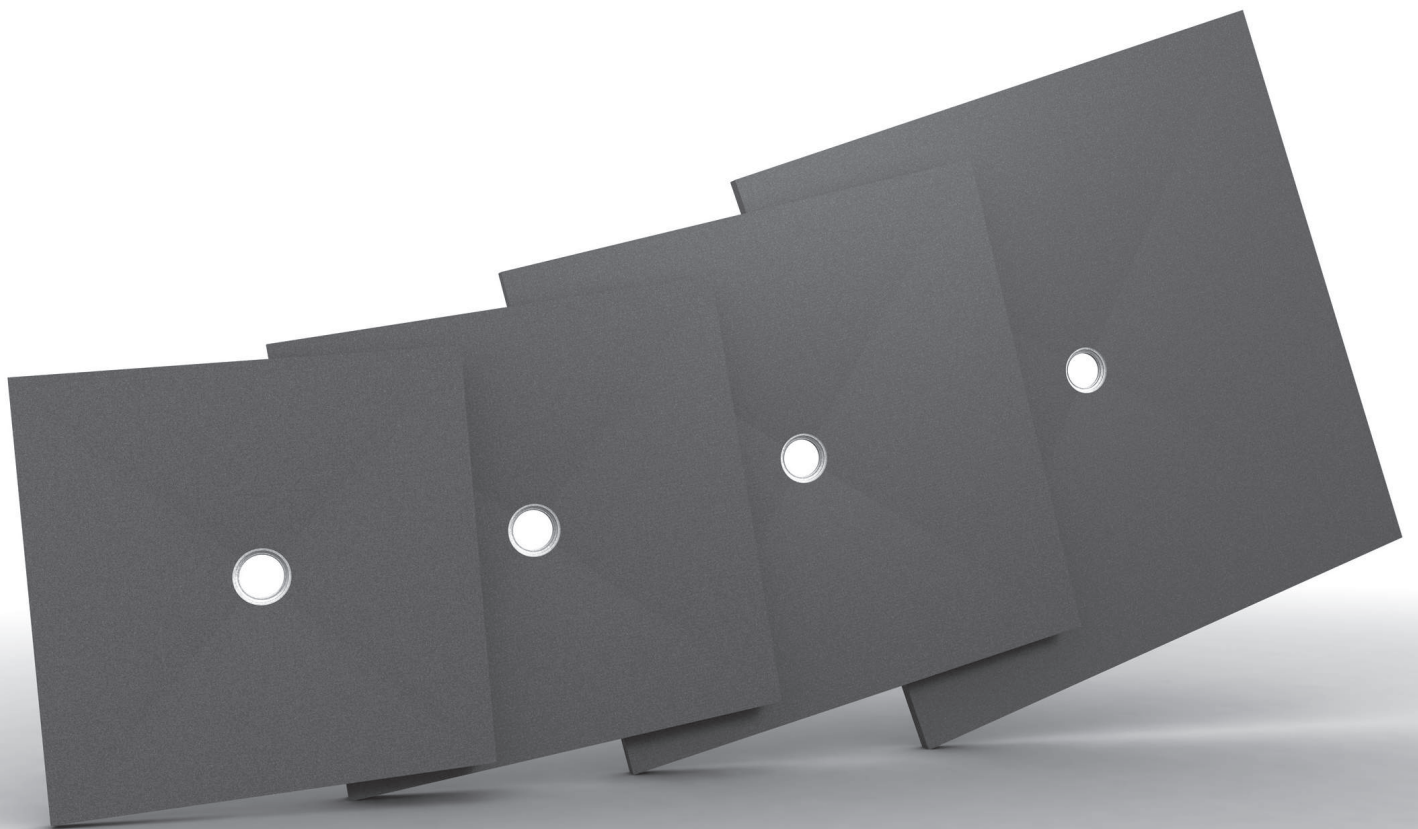

Fundo Primo (Nautilo, Trollo, Borgo)

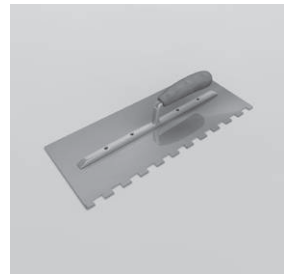

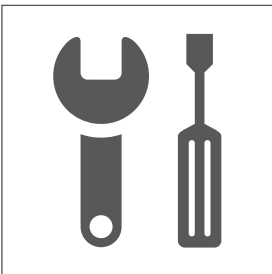

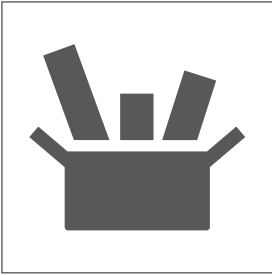
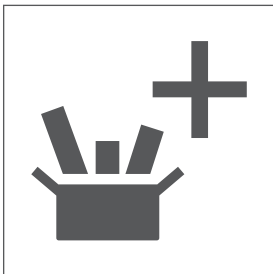
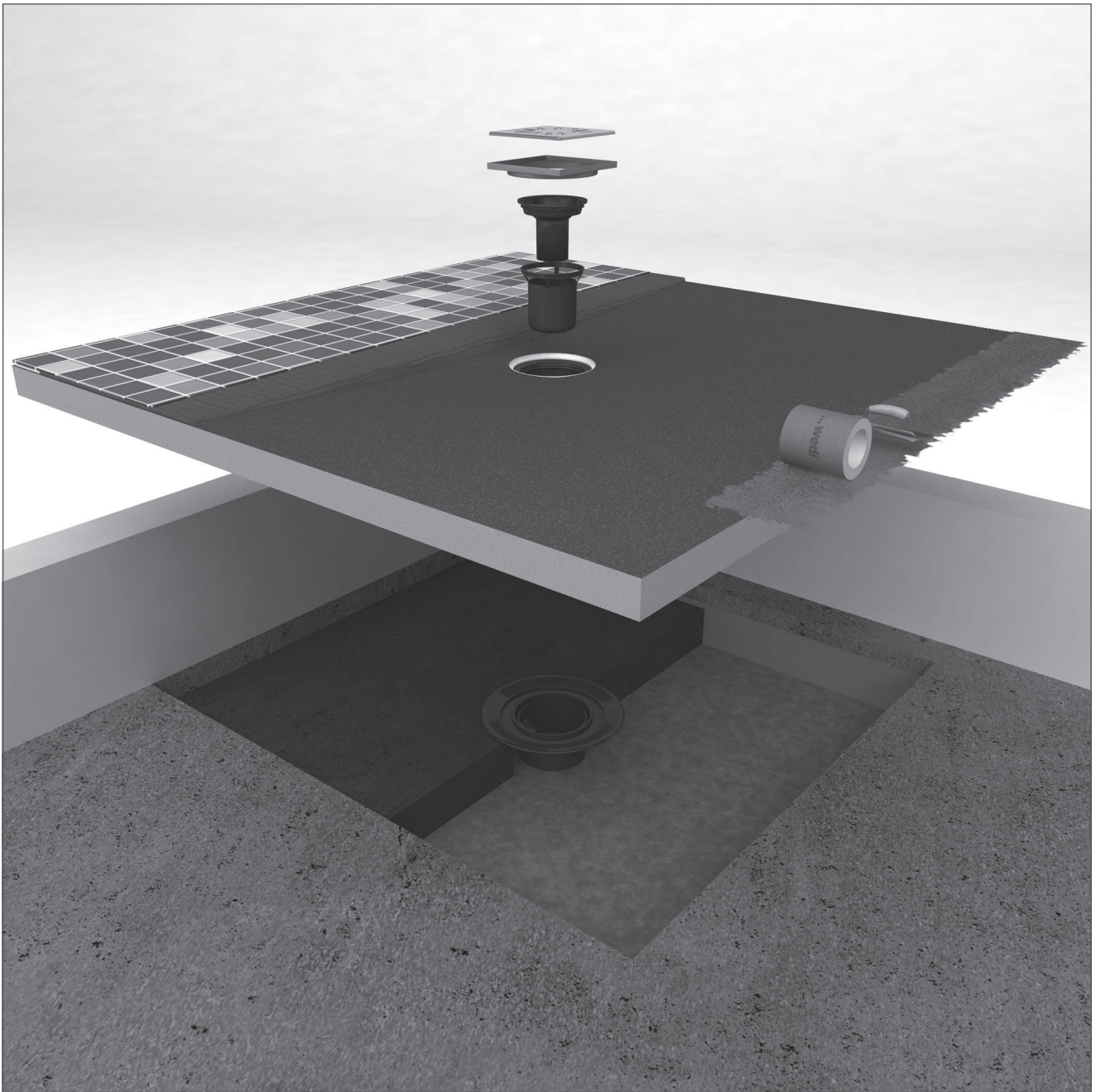

 0799 (System 2+)
wedi GmbH Hollefeldstraße 51 48282 Emsdetten 13 0799-CPR-132 DoP 0001
ETA-13/0385 ETAG 022 Teil 3
Bausatz mit wasserdichten Platten und weiteren Komponenten zur Herstellung einer Abdichtung unter einer Nuttschicht für die Verwendung in innen liegenden Nassbereichen Klassifizierung des Systems und deklarierte Produkt- und Systemeigenschaften siehe Anhang 1 der ETA-13/0385

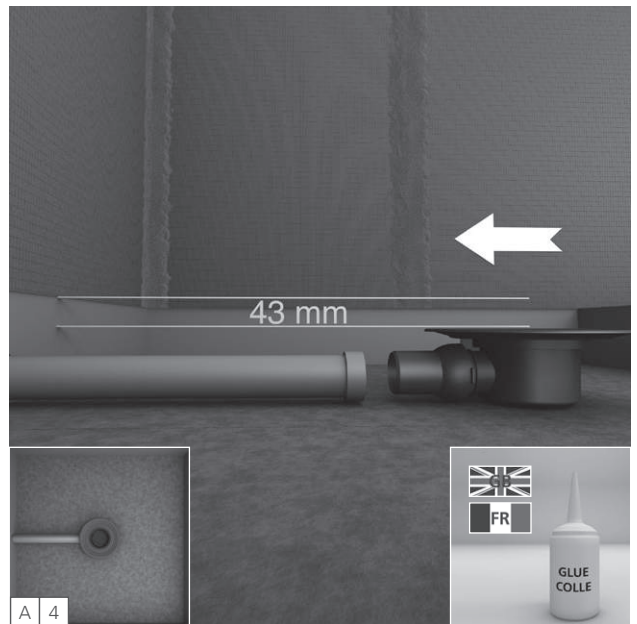
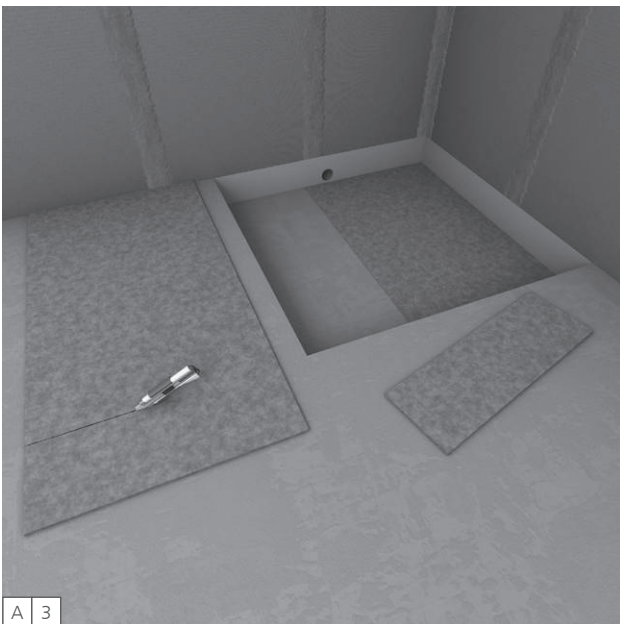
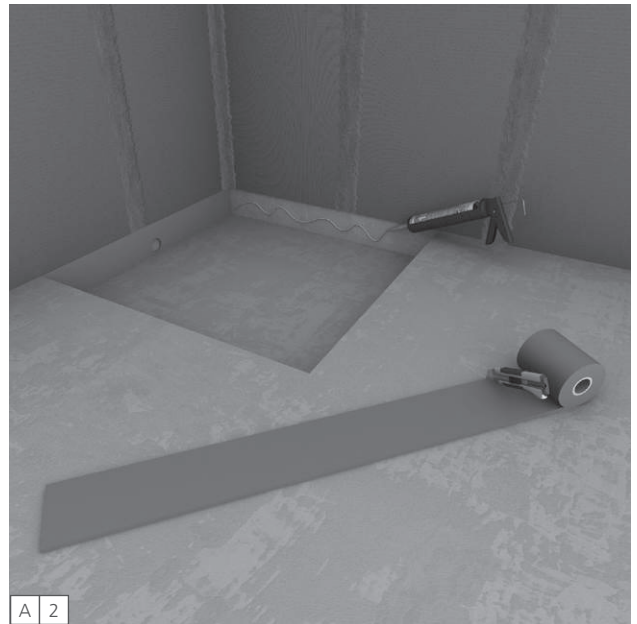
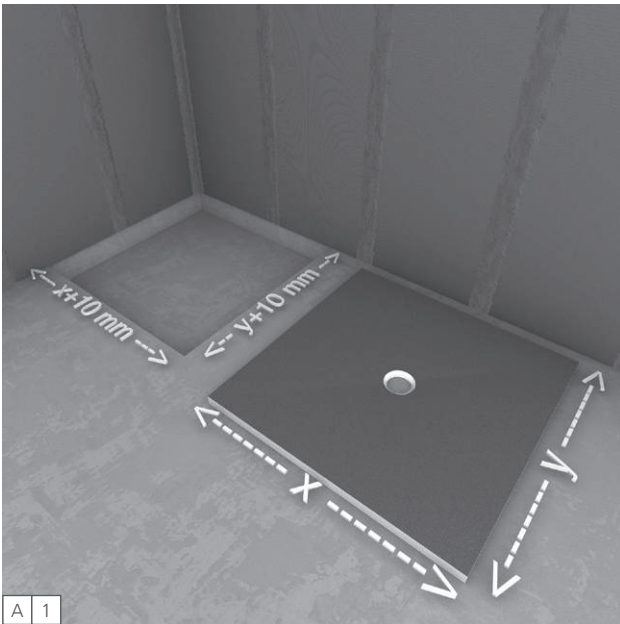
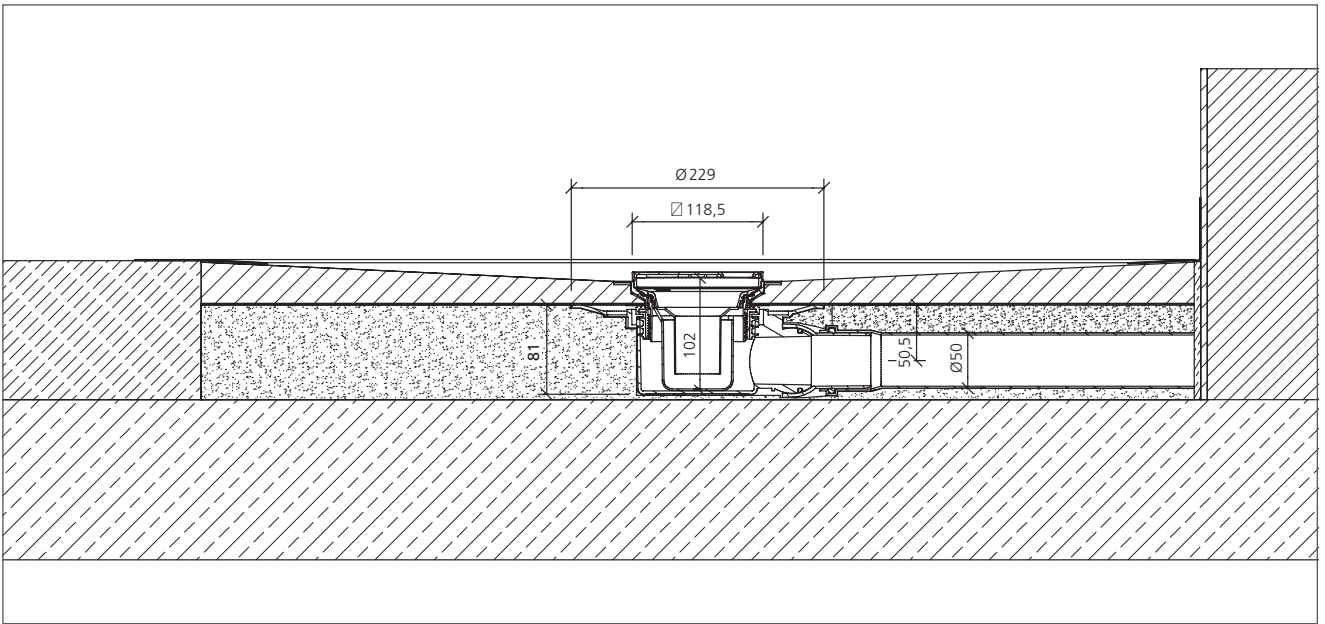

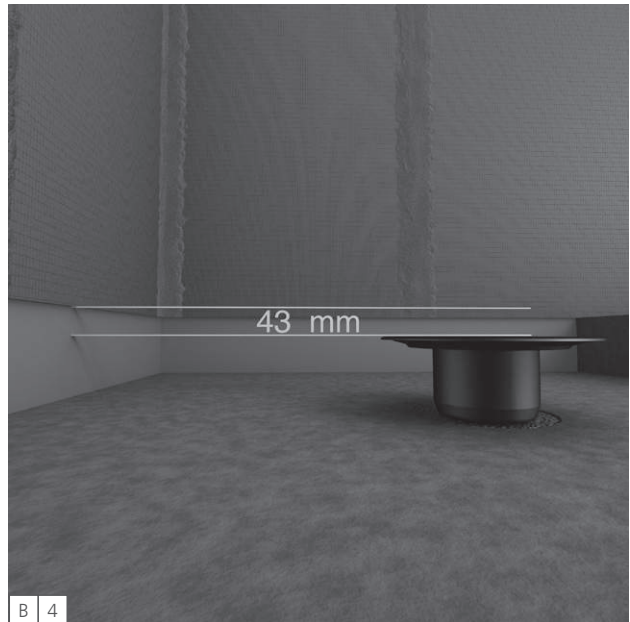
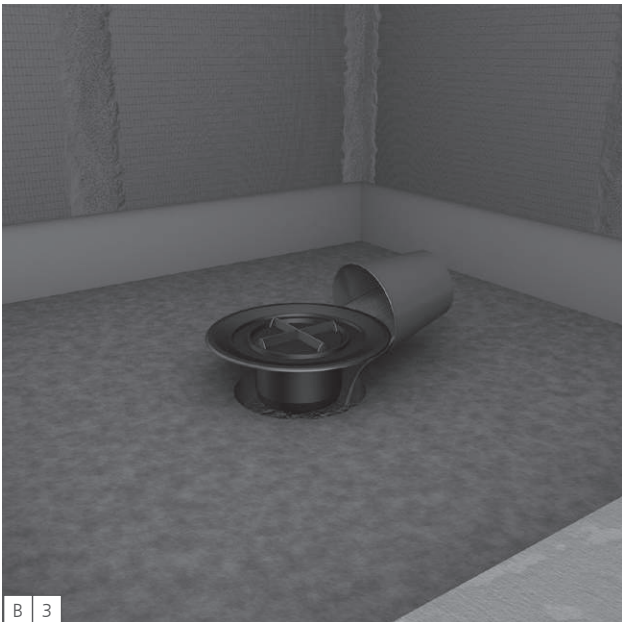
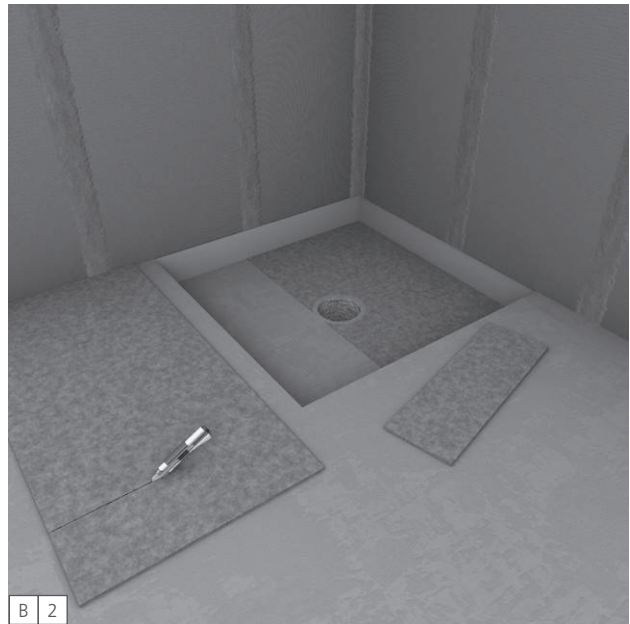
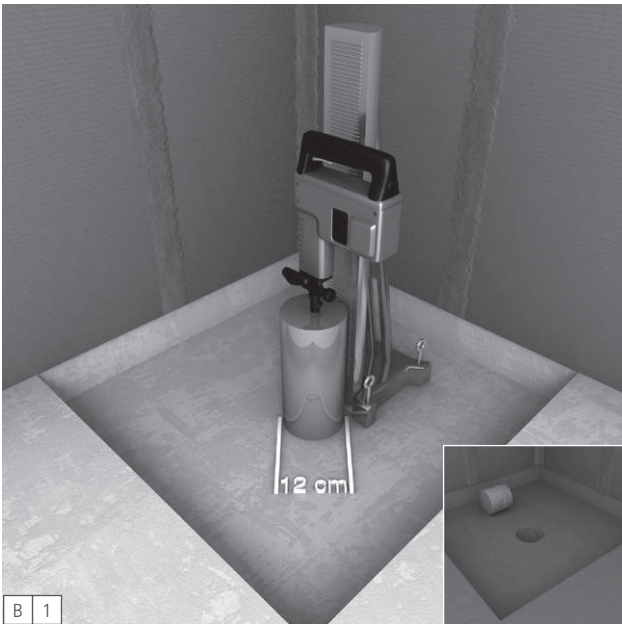
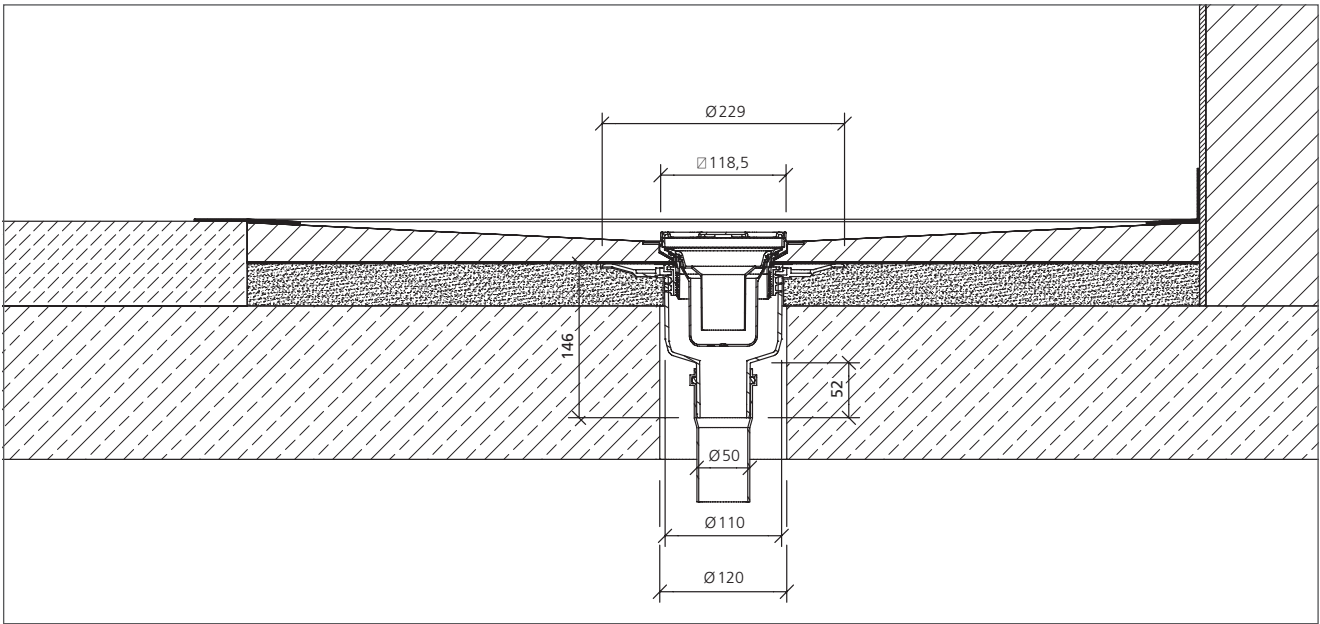

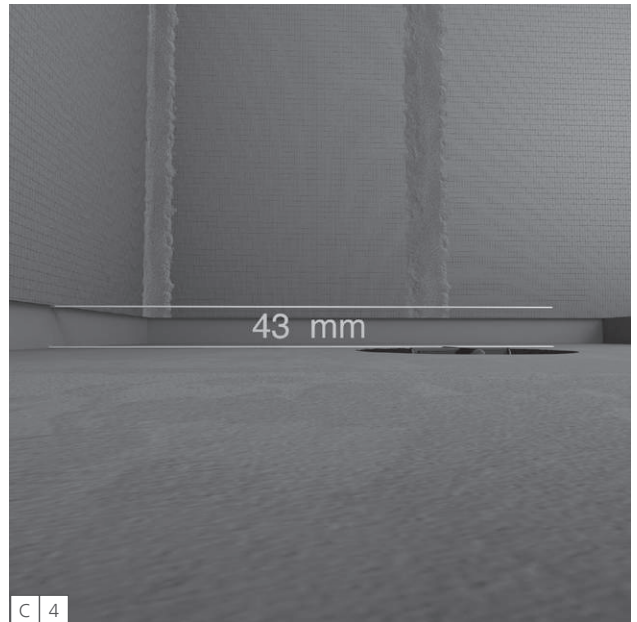
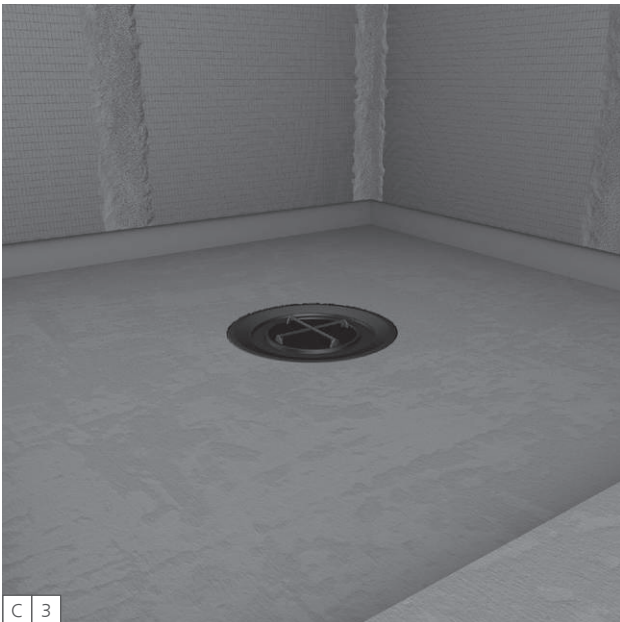
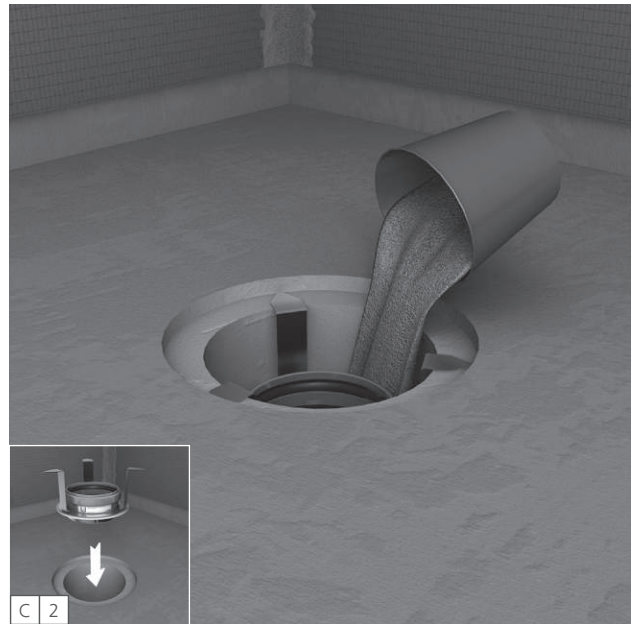
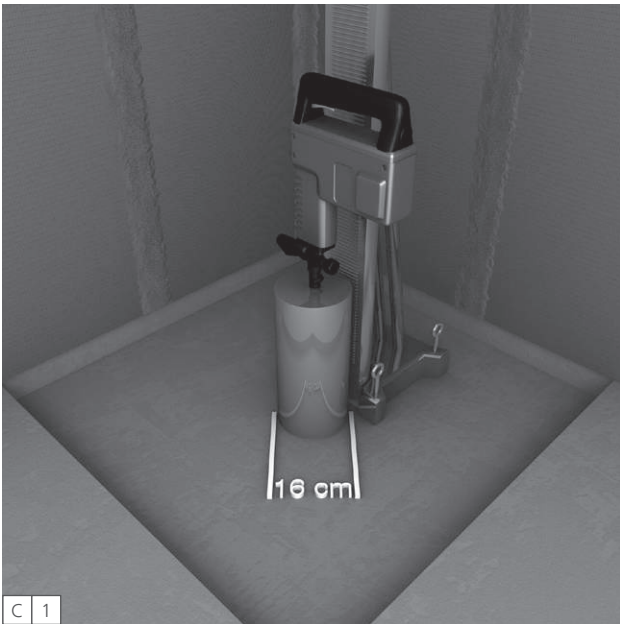
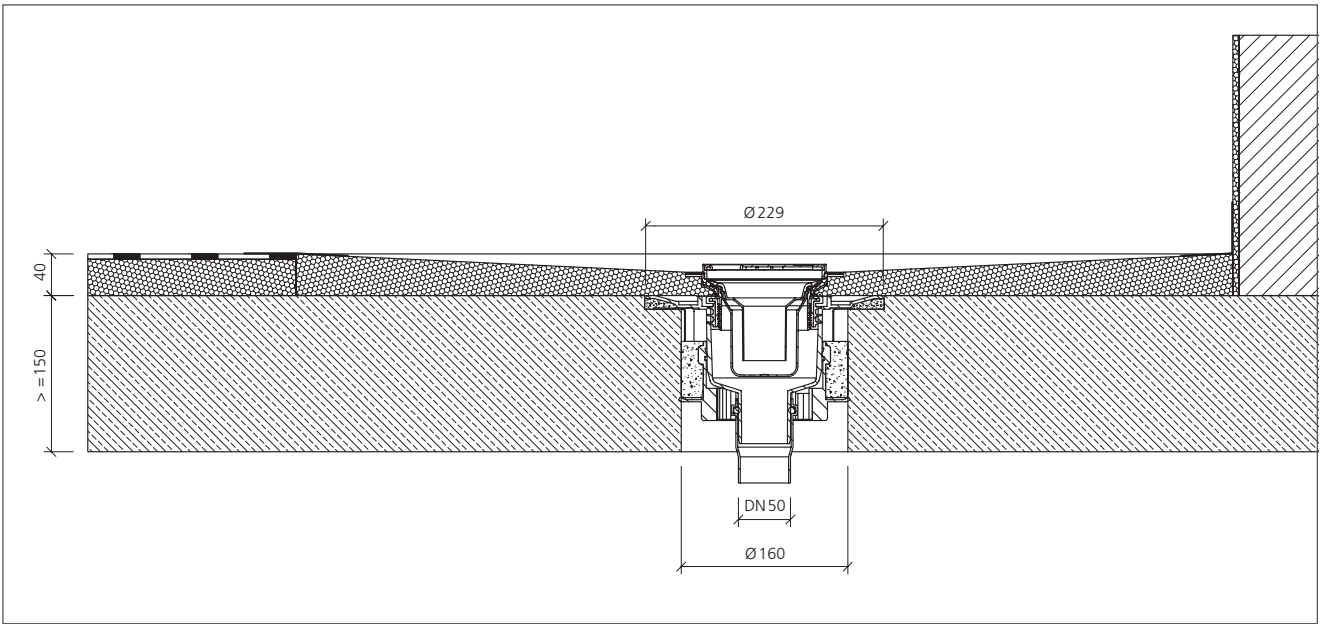

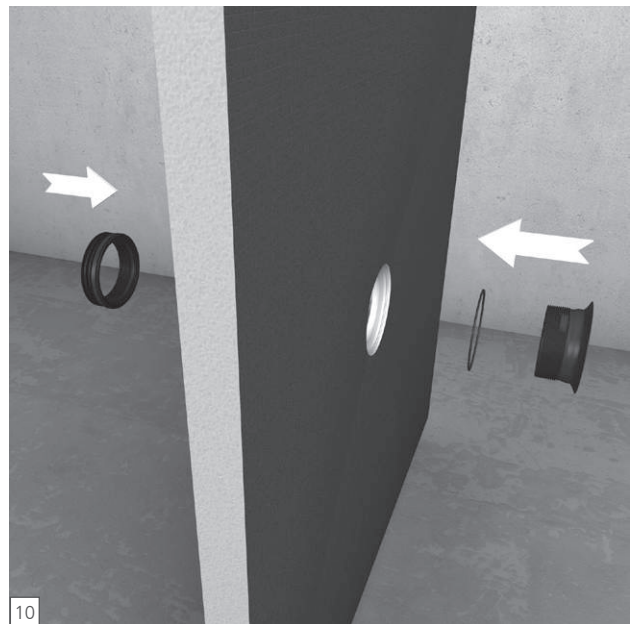
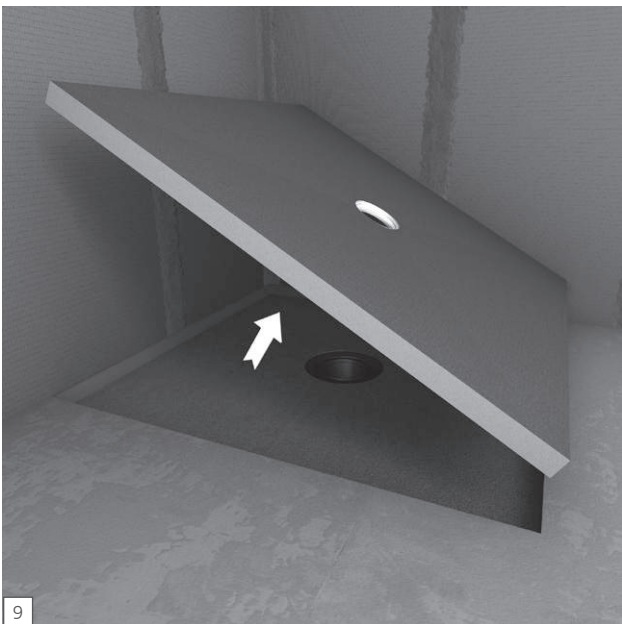
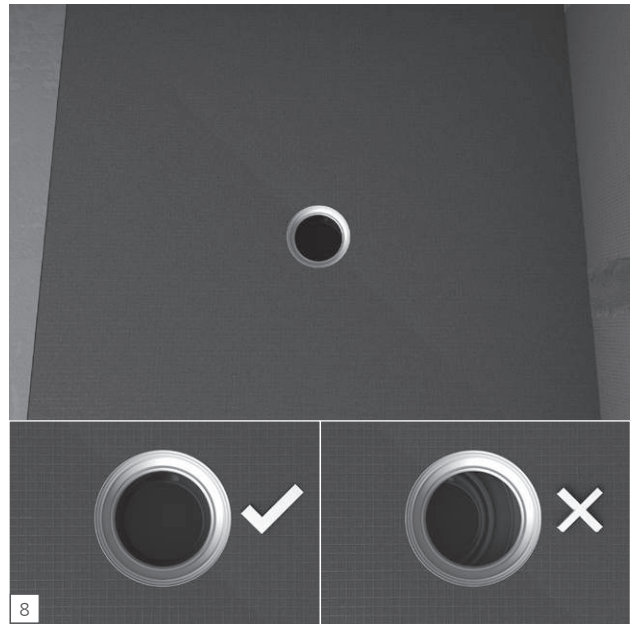
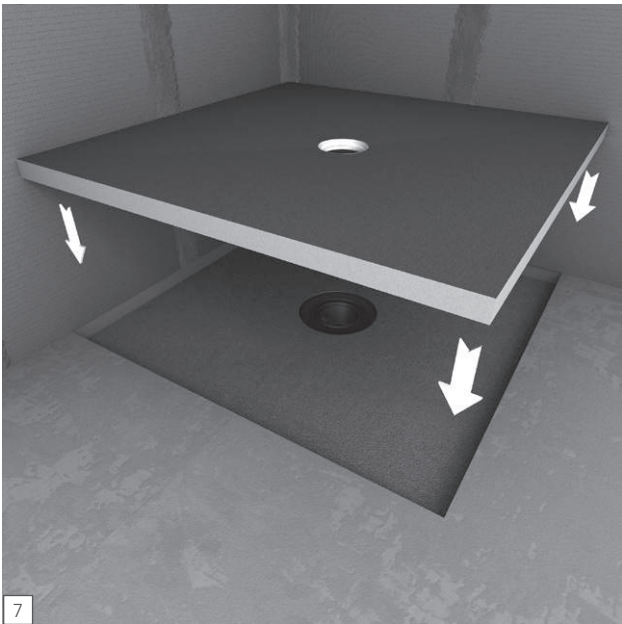
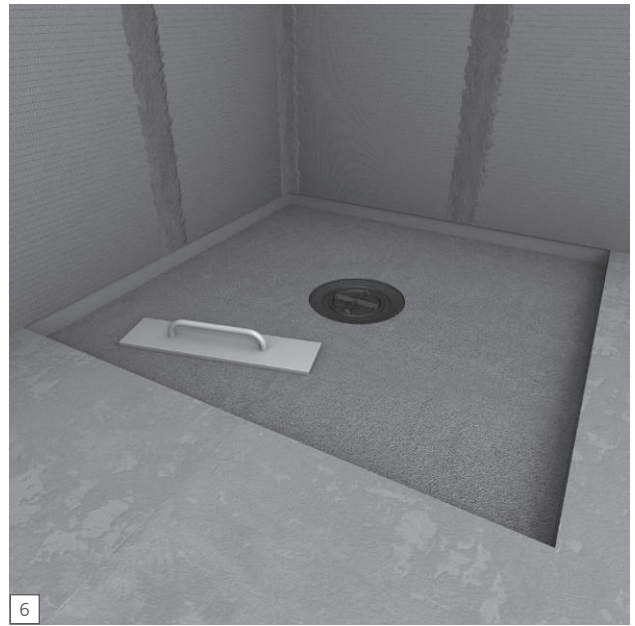
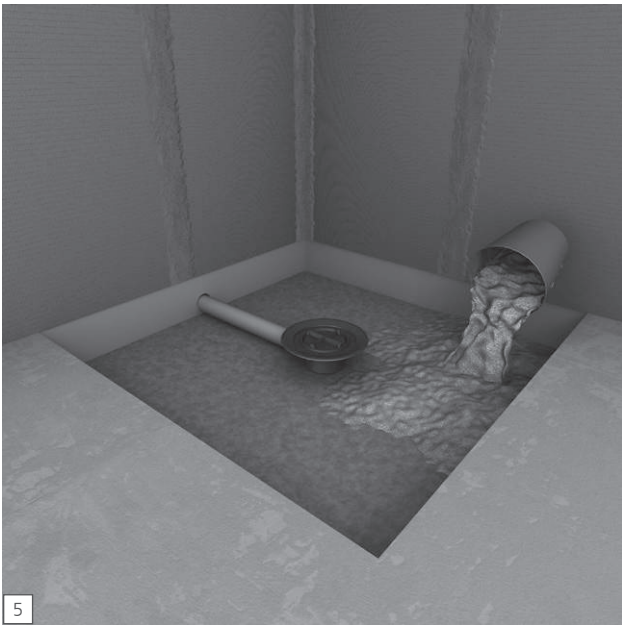

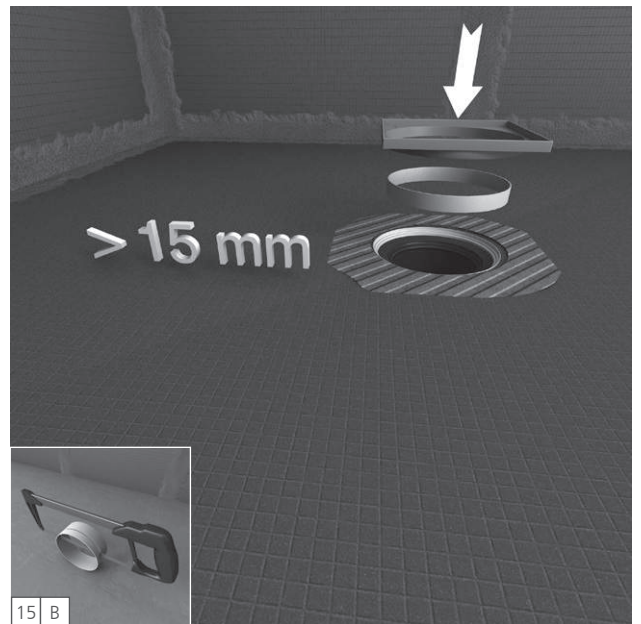
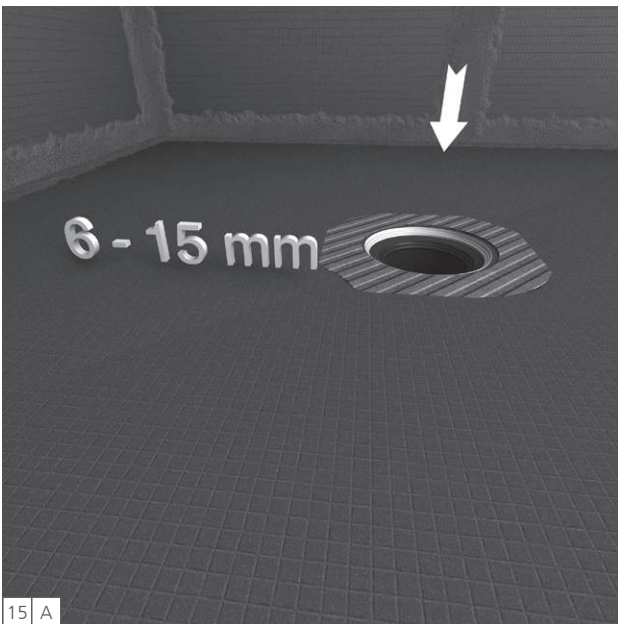
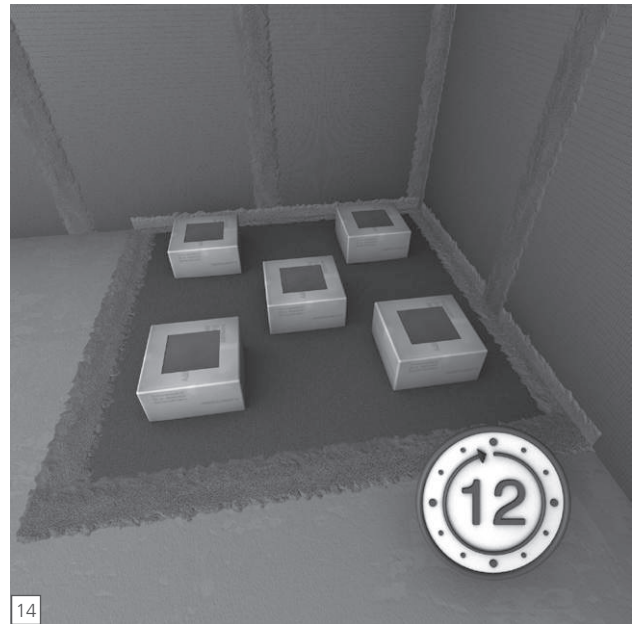
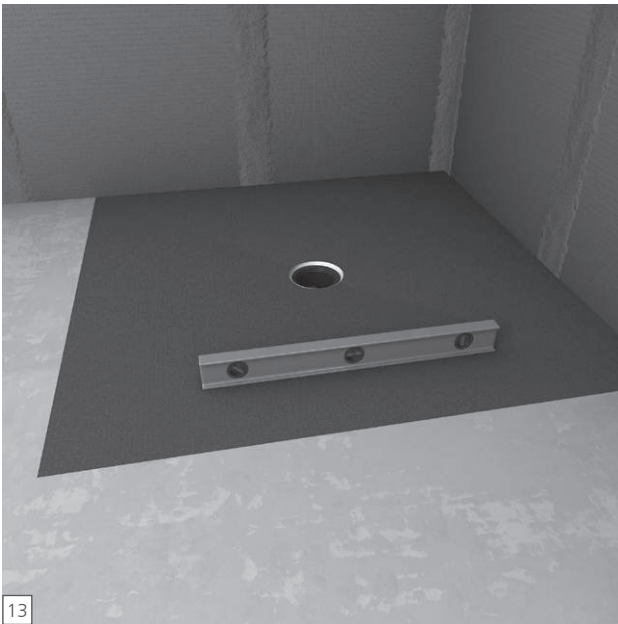
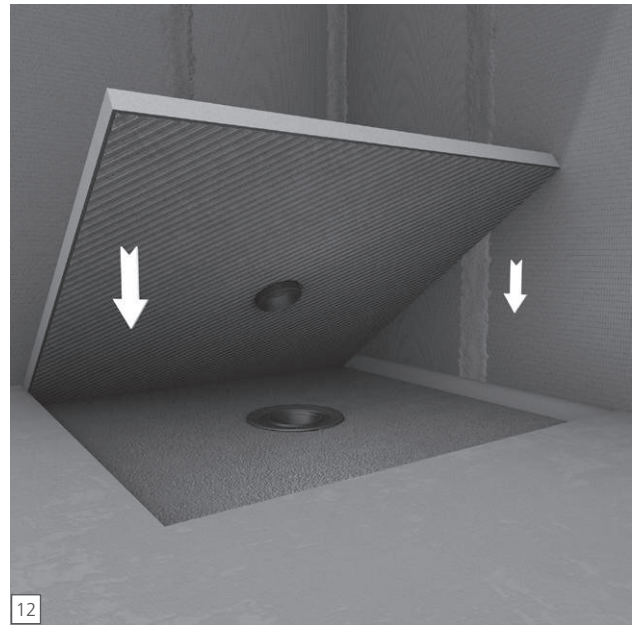
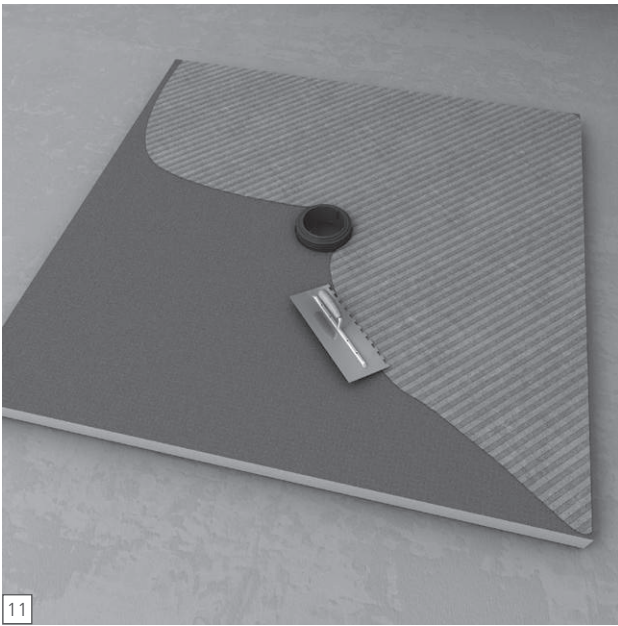

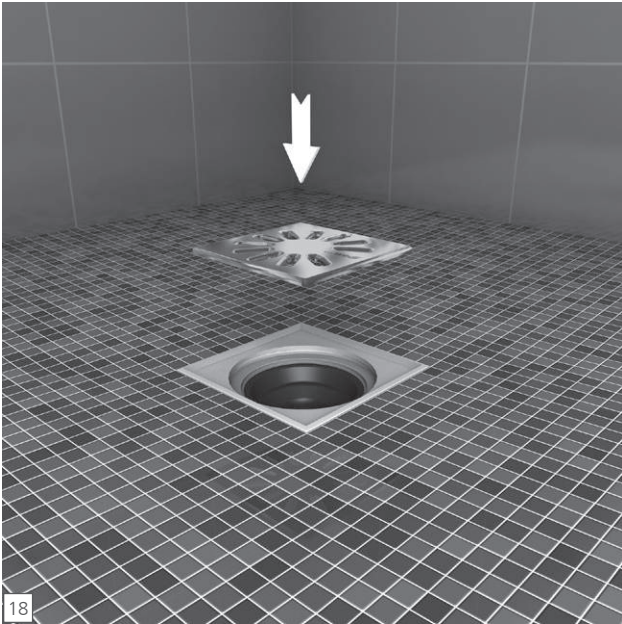
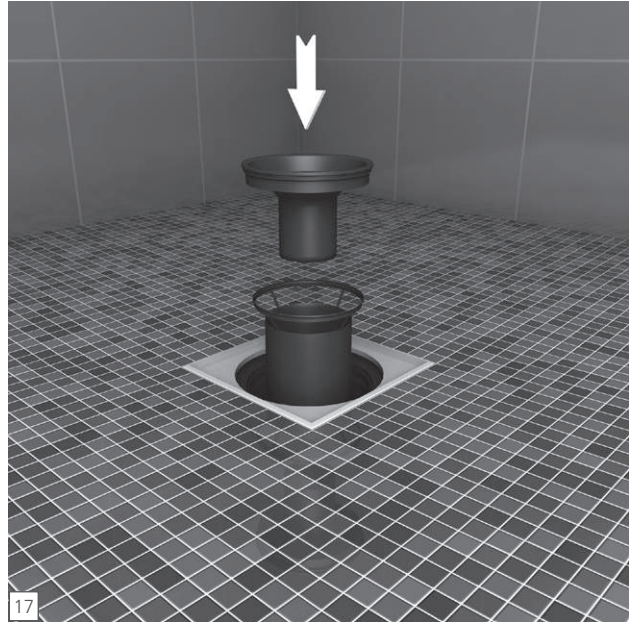

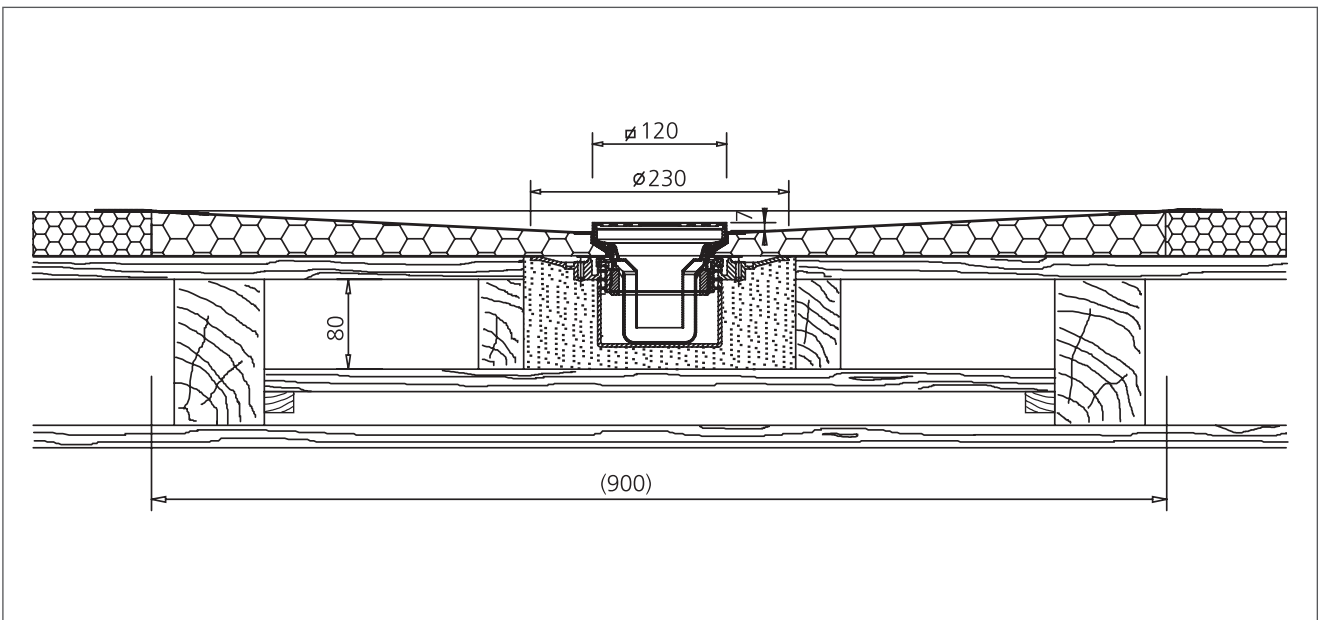
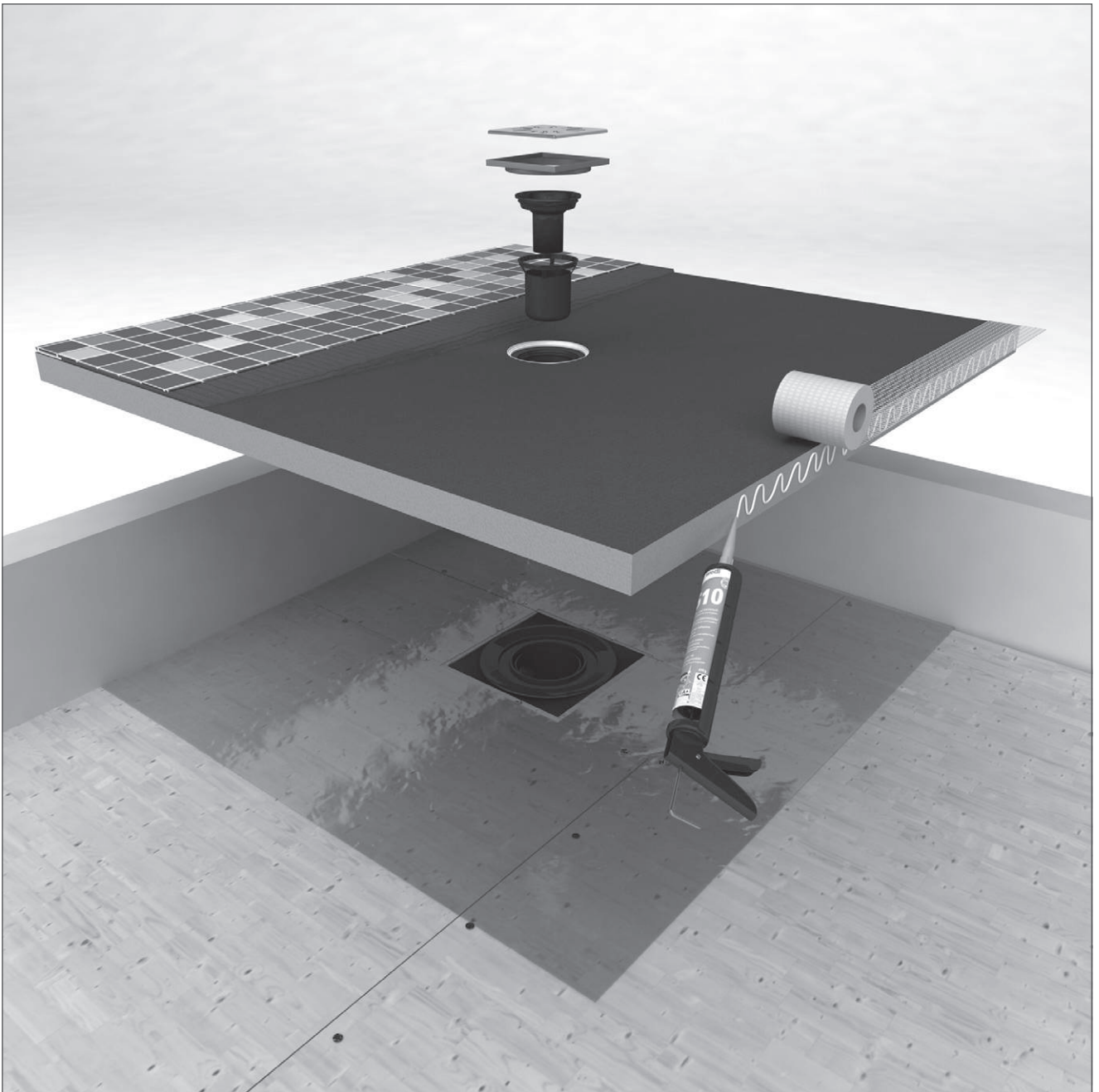

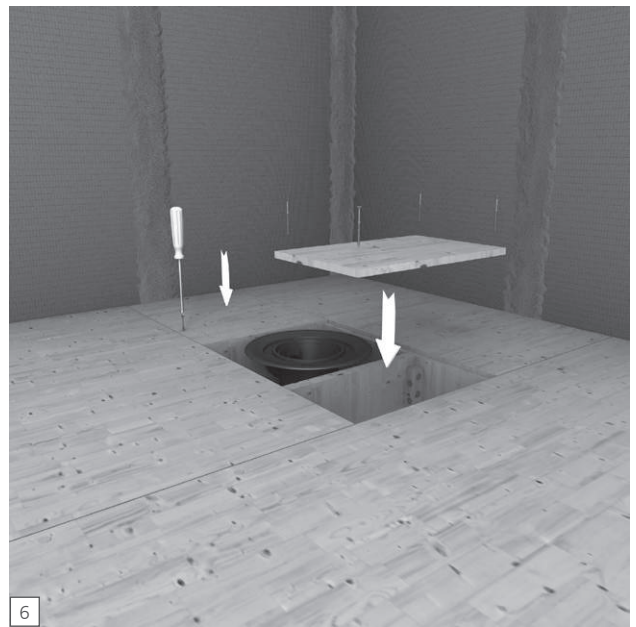
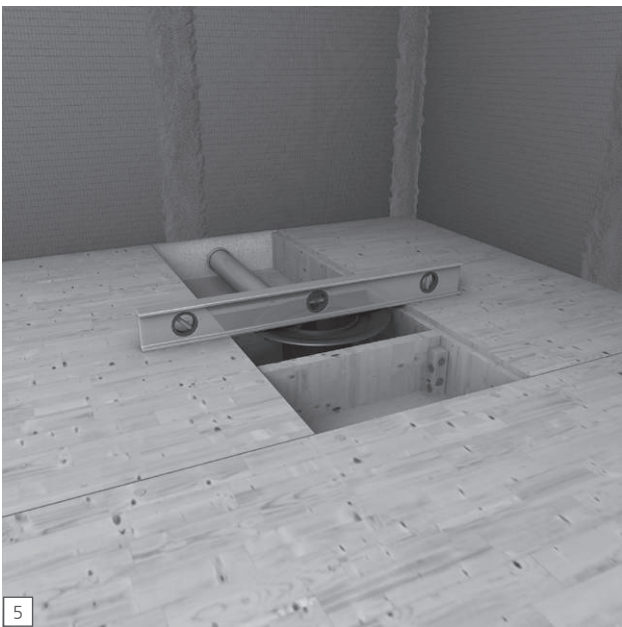
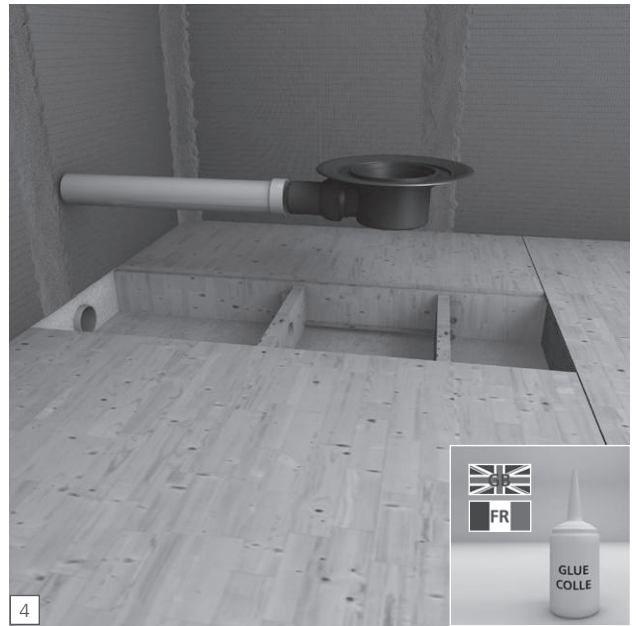
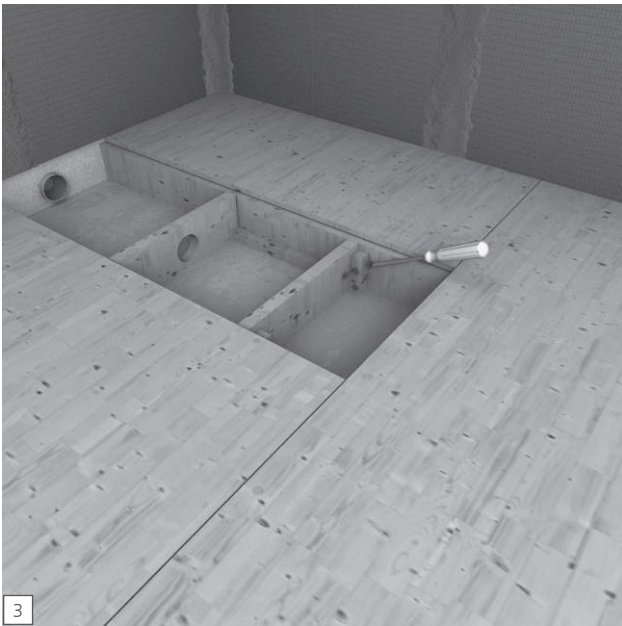
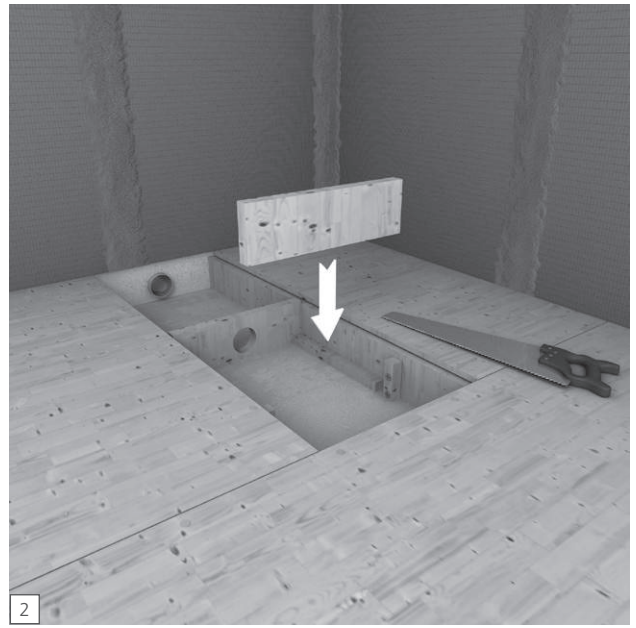
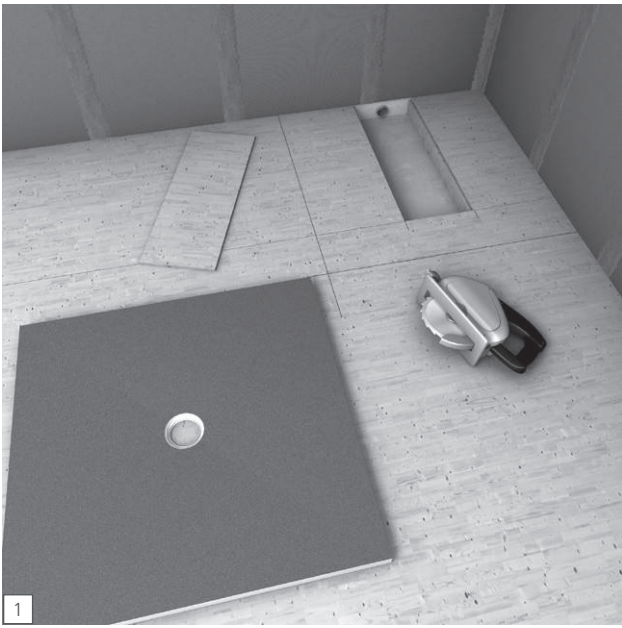

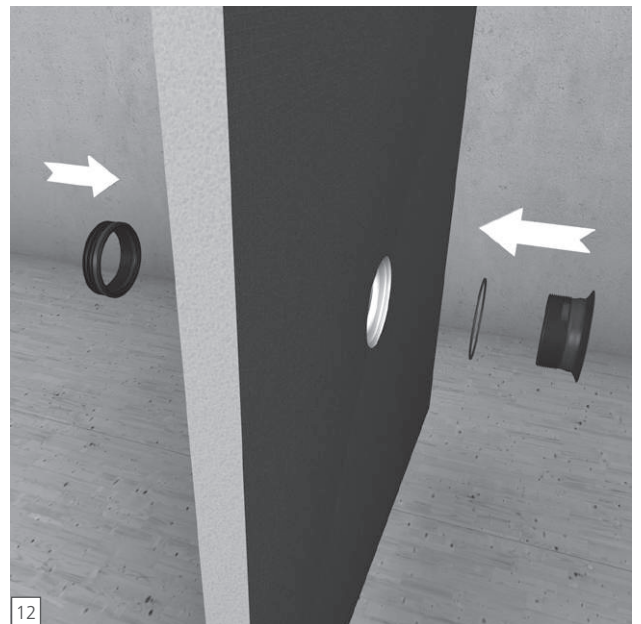
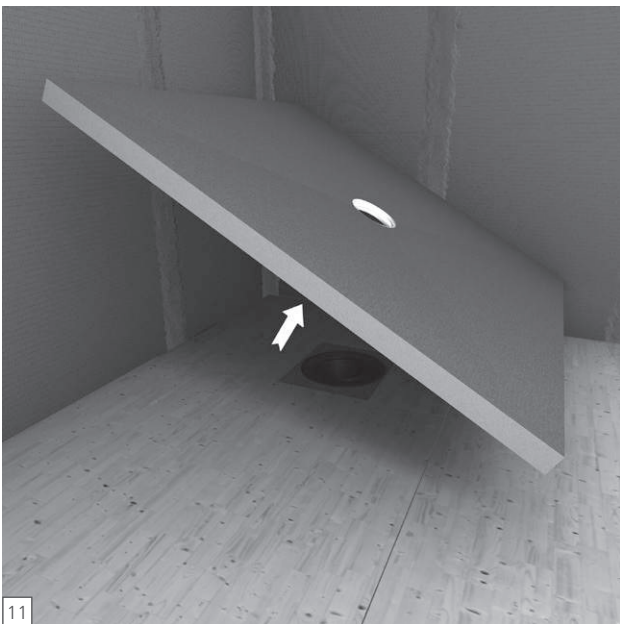
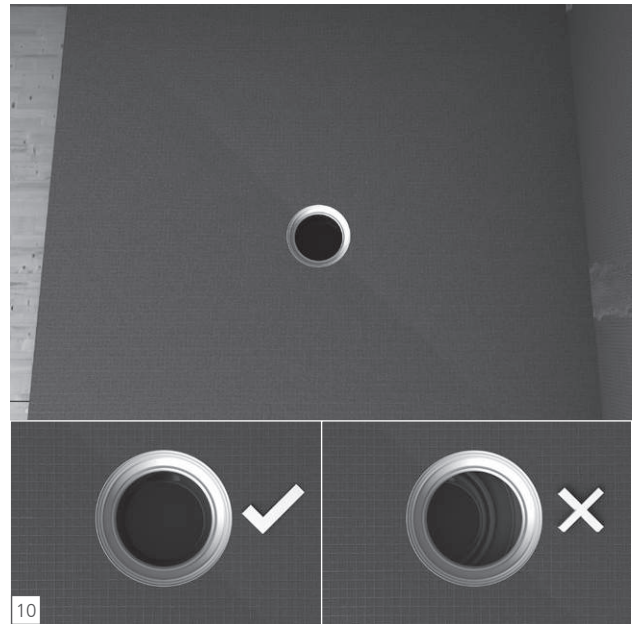
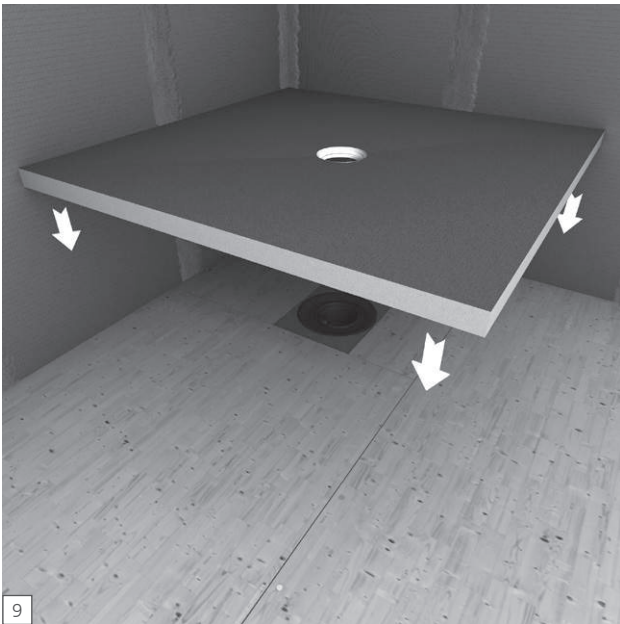
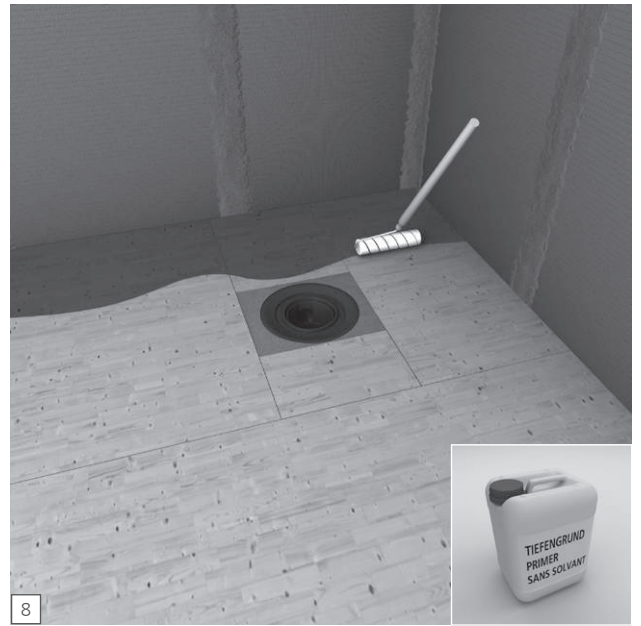
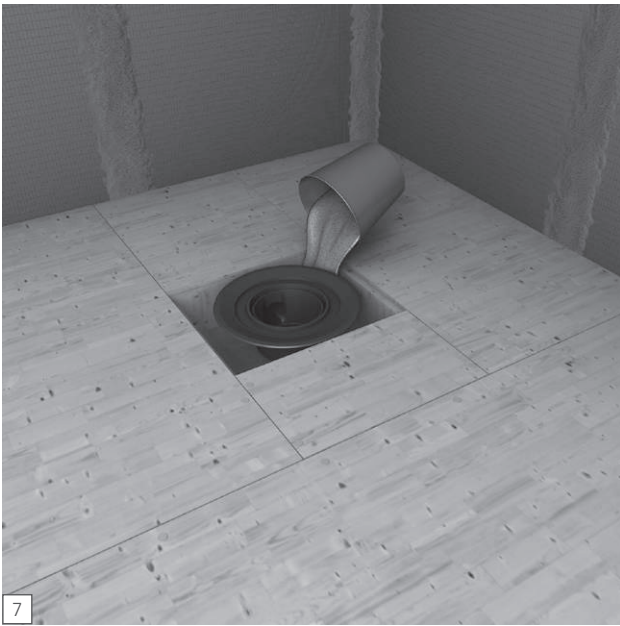

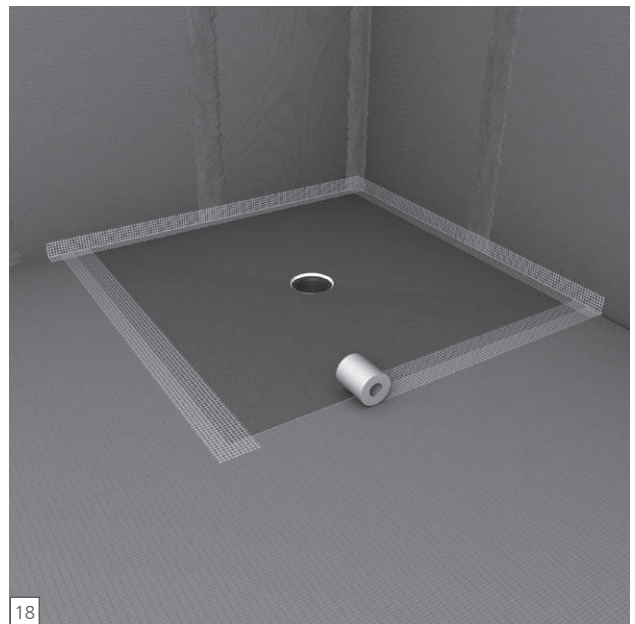
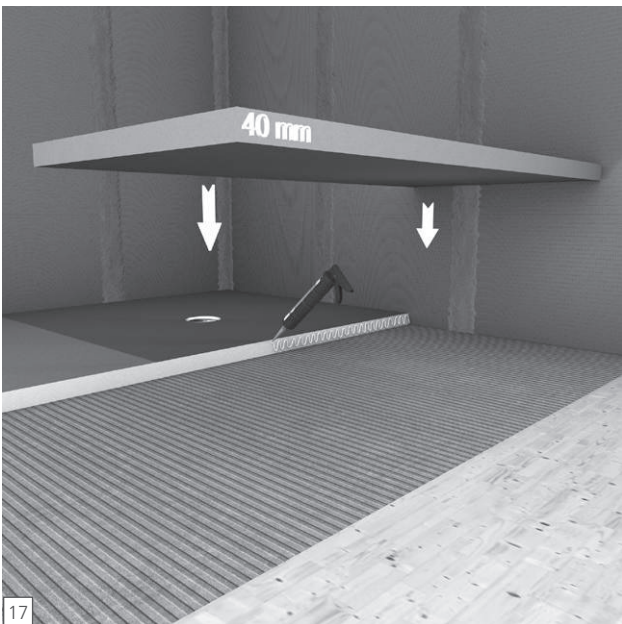
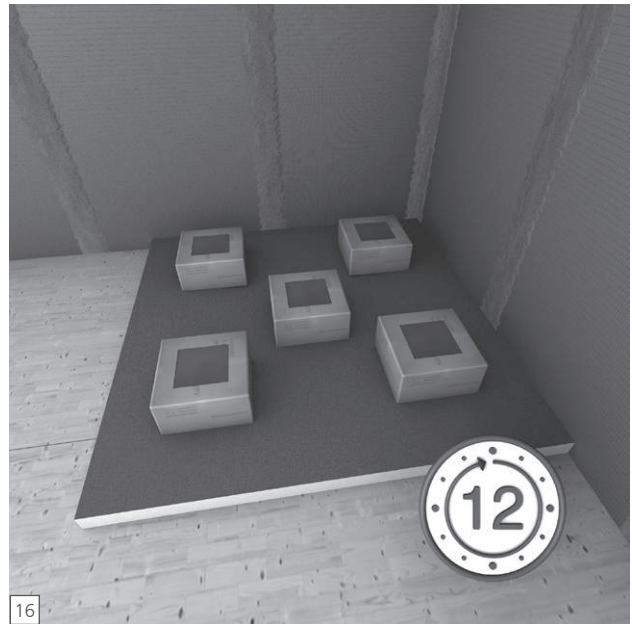
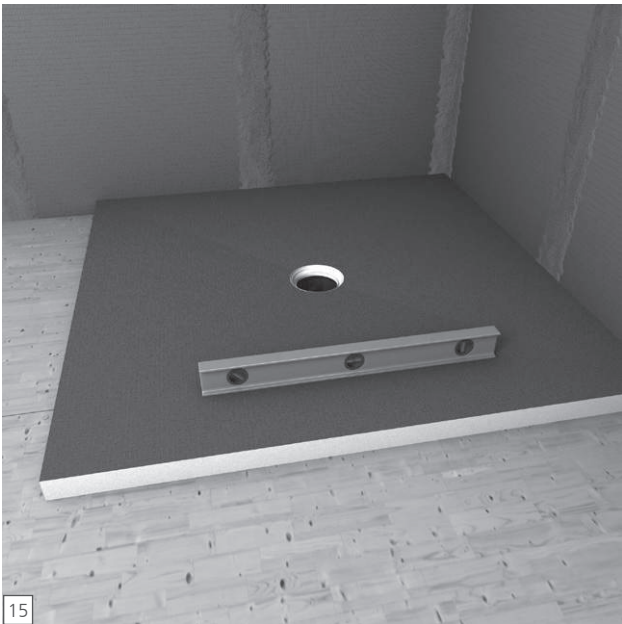
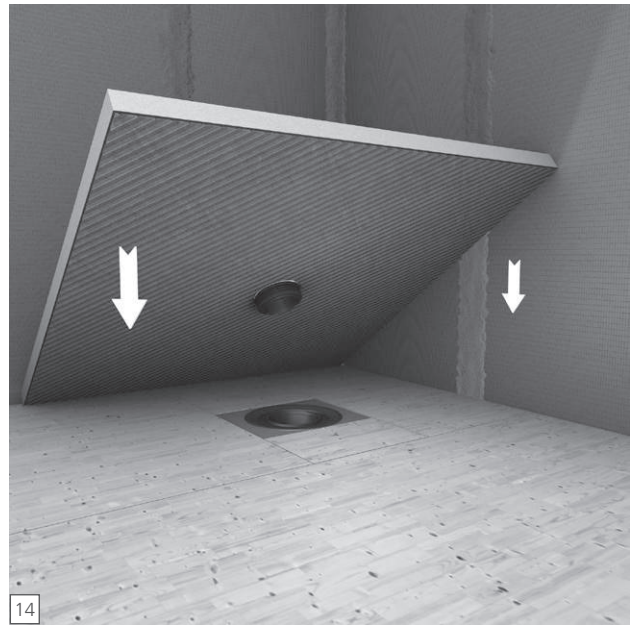
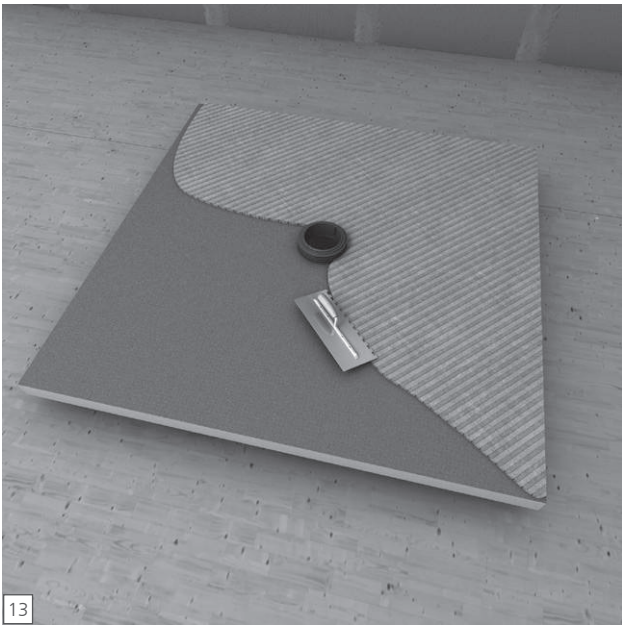

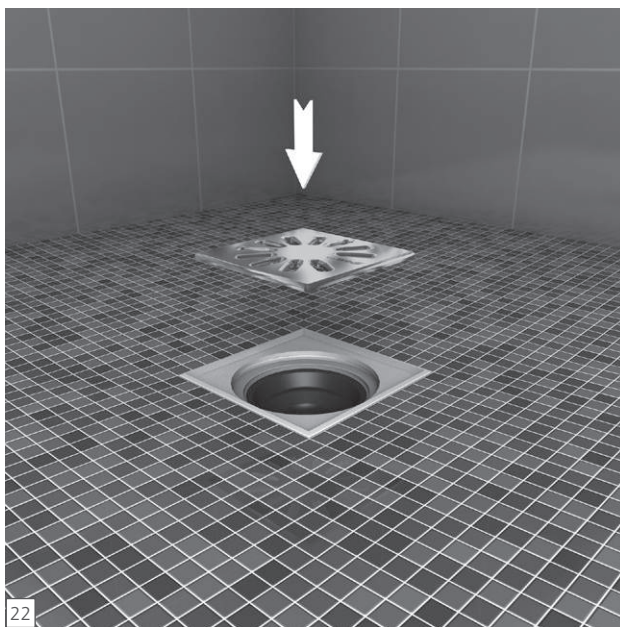
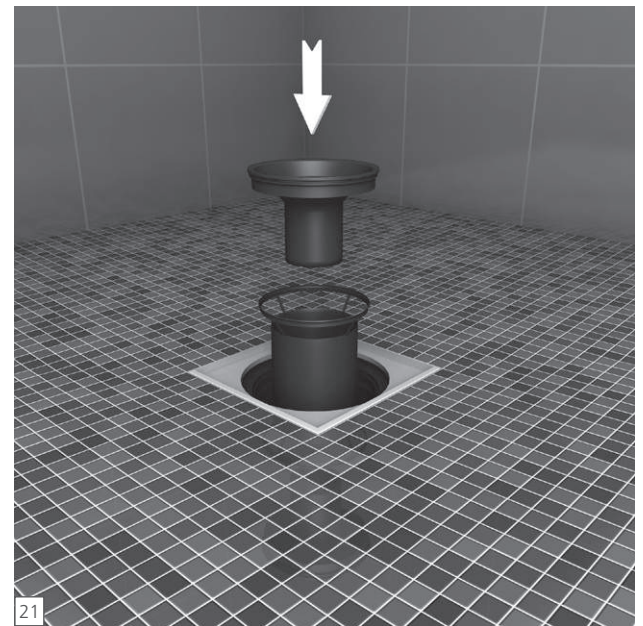
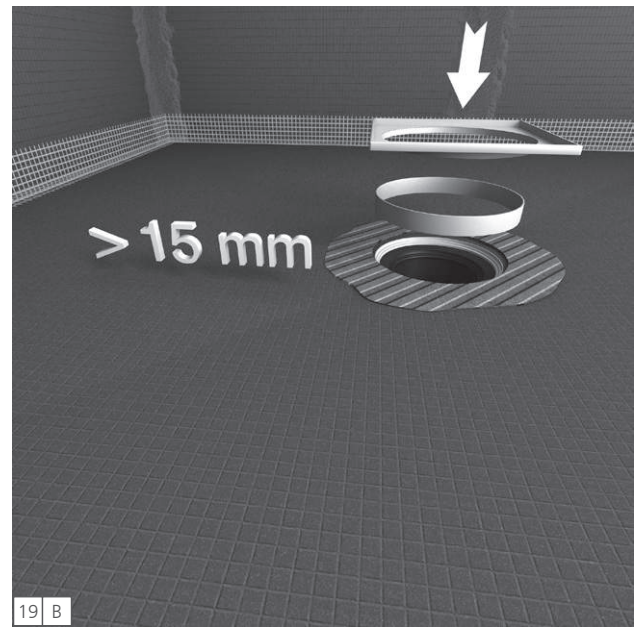
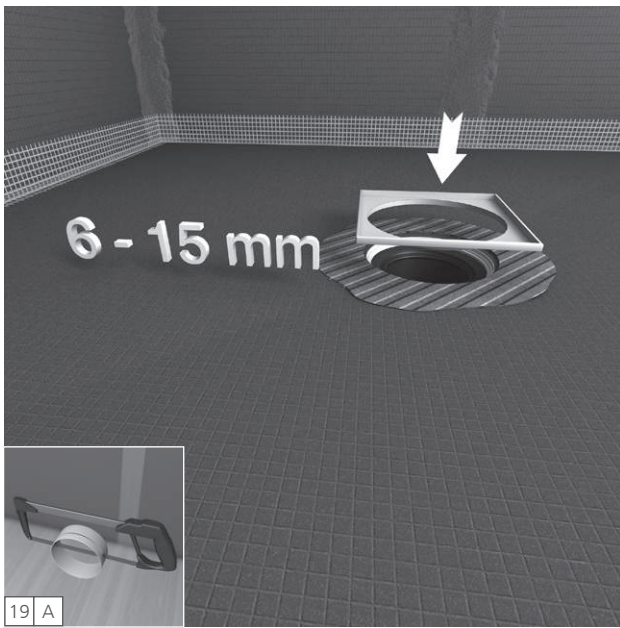



wedi GmbH

Hollefeldstraße 51
48282 Emsdetten
Deutschland

Telefon +49 2572 156-0
Telefax +49 2572 156-133

info@wedi.de
www.wedi.eu