

150 MM

18 MM

DS2



Pr-drilled for use with concealed fixings
 Preperce pour fixation invisibles
 Pr-geboord voor gebruik met verborgen bevestigingen
 Pr-forato per l'uso con fissaggi nascosti
 Preperforado para uso con fijaciones ocultas
 Pr-perfurado para uso com fixações ocultas
 Vorgebohrt für verborgene Befestigungen

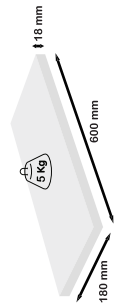
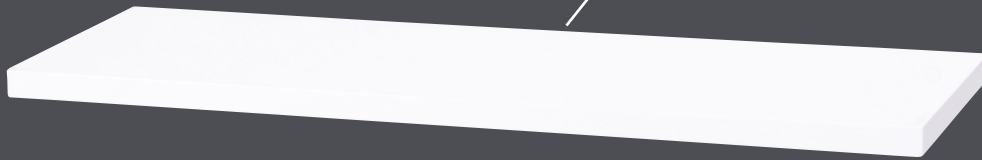

160 MM

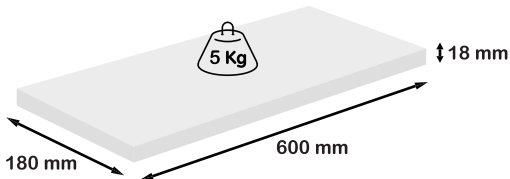

DS2

DS2

18 MM

GB Material: MDF E1

The maximum loads shown maybe lower depending on wall condition, Concealed fixings not included
 Screws and plugs not included

NL Materiaal: MDF E1

De aangegeven maximale draagkracht kan lager zijn afhankelijk van de staat van de muur.
 Inclusief verborgen niet bevestigingsmateriaal, Schroeven en pluggen niet inbegrepen

IT Materiale: MDF E1

I carichi massimi indicati forse inferiore a seconda delle condizioni della parete. Fissaggi invisibili non inclusi. Viti e tasselli non compresi

ES Material: MDF E1

La carga máxima indicada puede ser menor dependiendo de la condición de la pared. Fijación oculta no incluidos
 Tornillos y tacos no incluidos

DE Material: MDF E1

Abhängig von der Wandbeschaffenheit kann die maximale Belastbarkeit geringer als angegeben sein.
 Fixierungen invisibles nicht inbegriffen
 Schrauben und Dübel nicht im Lieferumfang enthalten

PT Material: MDF E1

Carga máxima mostrada a baixo, depende das condições da parede. Fixações invisíveis não incluídas
 Parafusos e buchas não incluídos.

FR Matière: MDF E1

La charge maximum dépend des conditions du mur.
 Fixations invisibles non incluses.
 Vis et chevilles non incluses.

www.maretan.com
 Importé par Maretan
 807200



40 MM

18 MM

150 MM

1

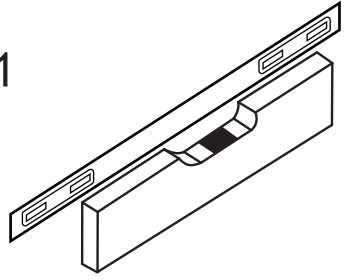

2

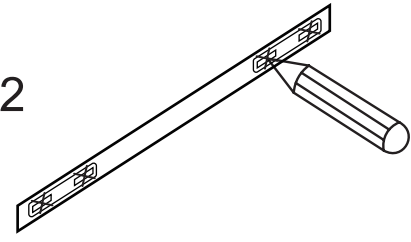

3

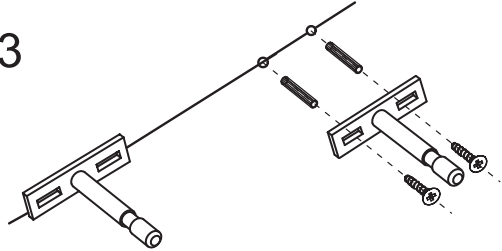

4

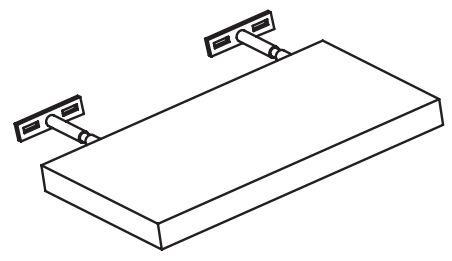

5

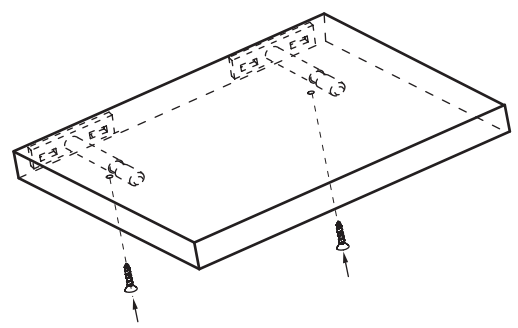

160 MM

18 MM

40 MM