

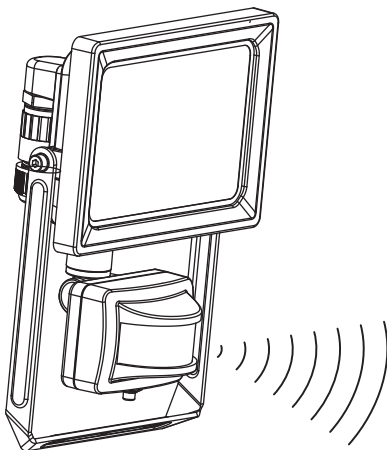

YONKERS

EAN : 3276007463880_3276007463903_3276007463941_3276007463989_3276007464092_3276007464115



2/2



2022/11-V01

FR Manuel d'Instructions

EL Εγχειρίδιο Οδηγιών

DE Anleitung Handbuch

ES Manual de Instrucciones

PL Instrukcja Obsługi

EN Instructions Manual

PT Manual de Instruções

UA Інструкція з Експлуатації

IT Manuale di Istruzioni

RO Manual de Instrucțiuni

* Garantie 5 ans / 5 años de garantía / Garantia de 5 anos / Garanzia 5 Anni / Εγγύηση 5 ετών / Gwarancja 5-letnia / Гарантія 5 років / Garanție 5 ani / Garantia de 5 anos/ 5-year-guarantee

** réparable / reparabile / reparável / riparabile / διορθώσιμος/naprawiany / ремонтний / reparabil/repairable



Montage / Montaje / Montagem / Montaggio / Συναρμολόγηση / Montaž / Збірка /
Ansamblu / Montaje / Montage / Assembly



Utilisation / Utilizațiōn / Utilizaçāo / Uso / Χρήση / Użytkowanie /
Використовуйте / Utilizați / Utilizare / Verwenden Sie / Use



1/2



FR : CARACTERISTIQUES TECHNIQUES / ES : CARACTERÍSTICAS TÉCNICAS / PT : CARACTERÍSTICAS TÉCNICAS / IT : CARATTERISTICHE TECNICHE / EL : ΤΕΧΝΙΚΑ ΧΑΡΑΚΤΗΡΙΣΤΙΚΑ / PL : DANE TECHNICZNE / UA : ТЕХНІЧНІ ХАРАКТЕРИКИ / RO : CARACTERISTI TEHNICE / DE : TECHNISCHE MERKMALE / EN : TECHNICAL CHARACTERISTICS



1



2



5



6



7



8



10



26



30



36



EAN CODE

3276007463880 3276007463903/ 3276007463941/ 3276007463989
3276007464092 3276007464115



9

10W

20W

30W

50W

- FR** Ce produit contient une source lumineuse de classe d'efficacité énergétique D .
- ES** Este producto contiene una bombilla de clase de eficiencia D .
- DE** Dieses Produkt enthält eine Leuchte der Energieeffizienzklasse D.
- PT** Este produto contém uma fonte de luz de eficiência energética de classe D .
- IT** Questo prodotto contiene una sorgente luminosa di classe di efficienza energetica D .
- EL** Αυτό το προϊόν περιέχει πηγή φως κατηγορίας ενεργειακής απόδοσης D .
- PL** Niniejszy produkt zawiera źródło światła klasy efektywności energetycznej D .
- UA** Данне изделие содержит источник света класса энергоэффективности D .
- RO** Acest produs conține o sursă de lumină din clasa de eficiență energetică D .
- EN** This product includes a light of the energy efficiency class D .

FR: PIÈCE RÉPARABLE / ES: PIEZA REPARABLE / PT: PARTE REPARÁVEL / IT: PARTE RIPARABILE / EL: ΕΠΙΣΚΕΥΑΣΙΜΟ ΜΕΡΟΣ / PL: CZĘŚĆ NADAJĄCA SIĘ DO NAPRAWY / UA: ЧАСТИНА, що підлягає ремонту / RO: PIESĂ REPARABILĂ / DE: REPARIERBARES TEIL / EN: REPAIRABLE PART

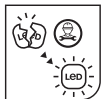

19



20

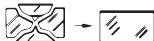

- FR** Remplacer tout écran de protection fissuré*
- ES** Sustituya toda pantalla de protección rota
- DE** Substitua os ecrãs de protecção partidos
- PT** Sostituire ogni schermo di protezione rotto
- IT** Αντικαθιστάτε τα σπασμένα προστατευτικά τζάμια
- PL** Należy wymieniac rozbity klosz
- EL** Ζαμνίτє бυдь-якнє потрнсканнєй захнсннєй щнток
- UA** Інlocуїтн ornce ecran de protecție spart
- RO** Înlocuїтн orice ecran de protecție spart
- UA** Substituir qualquer tela protetora quebrada
- RU** Ersetzen Sie jeden kaputten Schutzschirm
- EN** Replace any cracked protective shield



1



2

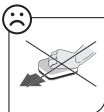

3



A

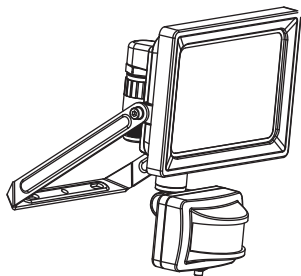

*Utiliser les vis et chevilles adaptées à votre support - Utilice tornillos y tacos adecuados para el soporte - Utilize buchas e parafusos adaptados à superfície de instalação - Utilizzare viti e tasselli adeguati al proprio supporto - Χρησιμοποιήστε τις κατάλληλες βίδες και ούπα για τον τοίχο σας - Таşıyıcıya uygun vida ve dübel kullanın - Используйте шурупы/крепления, которые подходят к основанию, к которому они будут крепиться - Використовуйтегвинти та штифти, що підходять для поверхні, на яку Ви монтуєте рошет/жалюзі - Należy korzystać ze śrub i kołków przystosowanych do nośnika - Utilizați șuruburile și diblurile adecvate suportului dvs - Use screws and dowels suited to your backing.

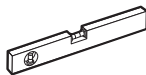

10w/20w **Ø6mm**
30w/50w/100w **Ø8mm**





1

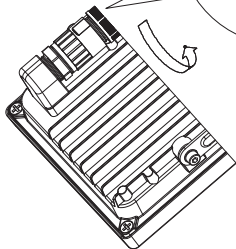
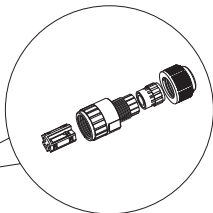
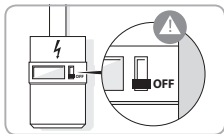

2

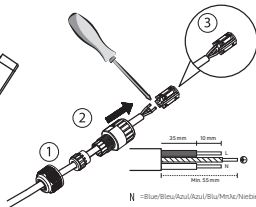
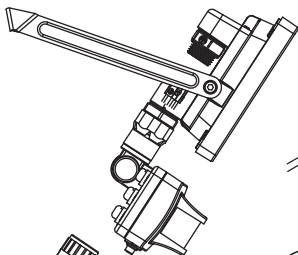

N = Blue/Bleu/Azul/Azu/Blu/Mezz/Niebieski/Cniw/Wilbastru

⊕ = Green and yellow/Vert et jaune/Verde e amarillo/Verde e giallo/
Зелёный и жёлтый/Зелёный і жовтий/Verde-gialben

L = Brown/Marron/Marrón/Castanho/Marrone/Kopřel/Brązowy/Koprievesivik/Maro

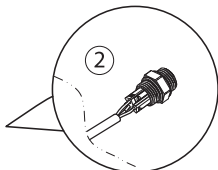
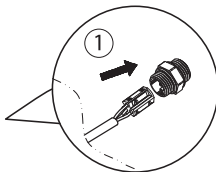
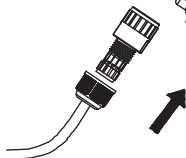

3

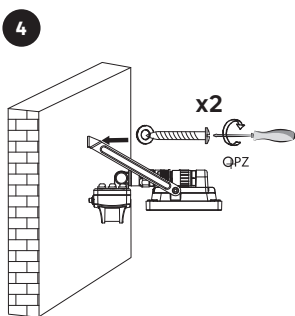
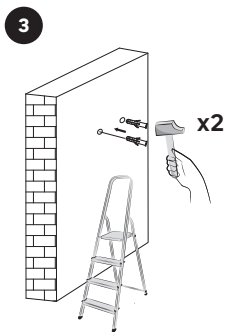
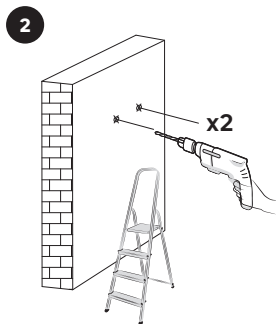
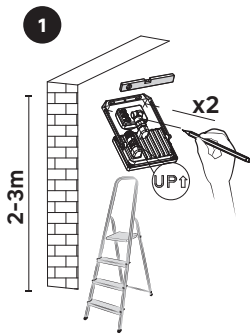

4

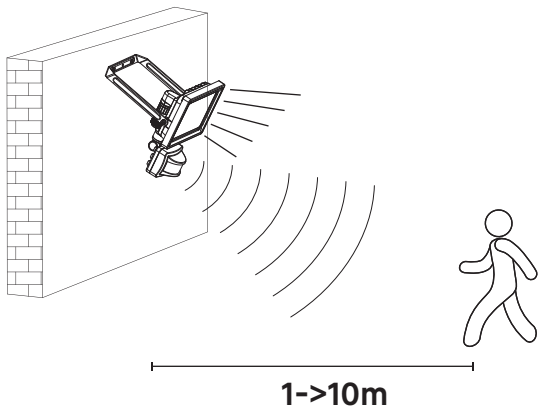
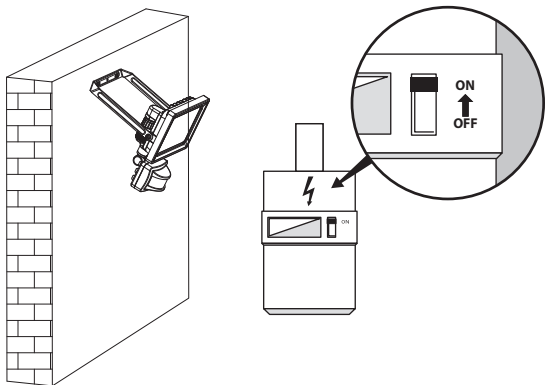



1

1

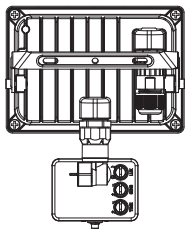

2

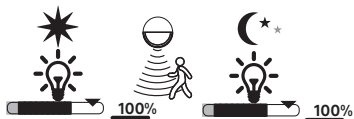
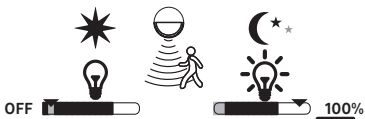
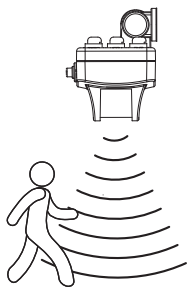
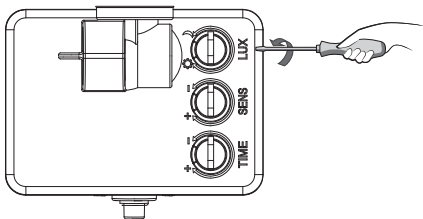

2

1

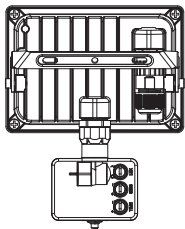

2

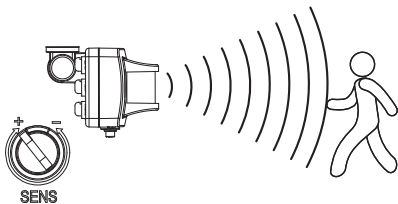
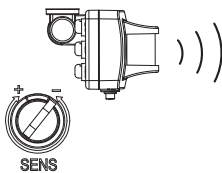
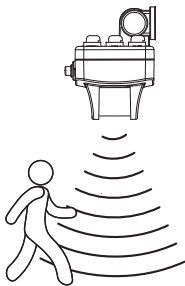
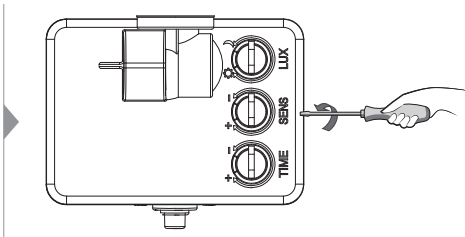

3

1

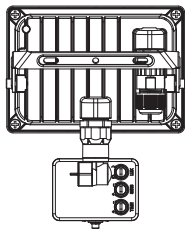

2

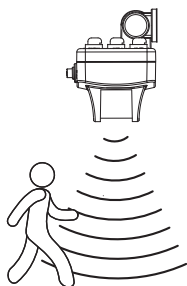
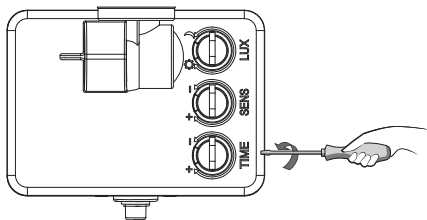

TIME



TIME



10s±8s



10min±1min



4

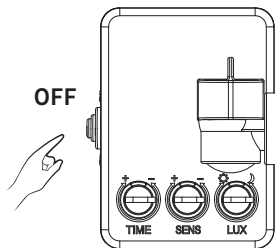
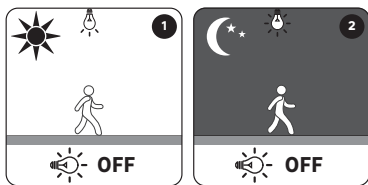
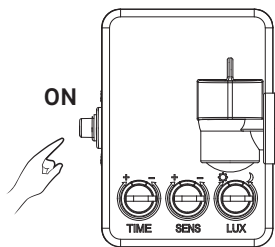
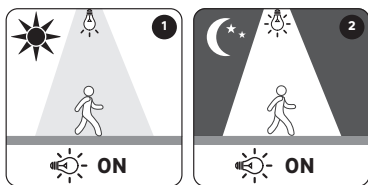
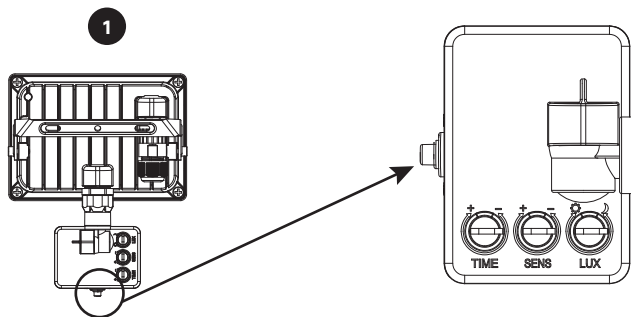



- FR** Ce produit est recyclable. S'il ne peut plus être utilisé, veuillez l'apporter dans un centre de recyclage de déchets.
- ES** Este producto es reciclable. Si ya no se puede usar, llévalo a un centro de reciclaje de residuos.
- PT** Este produto é reciclável. Se deixar de o utilizar, entregue-o num centro de reciclagem de resíduos.
- IT** Questo prodotto può essere riciclato. Se deve essere smaltito, portalo presso un centro di riciclaggio.
- EL** Αυτό το προϊόν είναι ανακυκλώσιμο. Εάν δεν μπορεί πλέον να χρησιμοποιηθεί, μεταφέρετε την σε κάποιο κέντρο ανακύκλωσης απορριμμάτων.
- PL** Ten produkt poddawany jest recyklingowi, kiedy przestaje być użyteczny należy dostarczyć go do punktu zbiórki odpadów.
- UA** Цей продукт може перероблятися. Якщо воно більше не є придатне для використання, здайте його в утилізаційний центр.
- RO** Acest produs este reciclabil. Dacă nu mai poate fi folosit, vă rugăm să îl aduceți într-un centru de reciclare a deșeurilor.
- BR** Este produto é reciclável. Se não puder mais ser usado, descarte em um centro de reciclagem de resíduos.
- DE** Dieses Produkt ist recycelbar. Wenn es nicht mehr verwendet werden kann, bringen Sie es bitte zum Recycling-Center.
- EN** This product is recyclable. If it cannot be used anymore, please take it to waste recycling centre.



Traduction de la version originale du mode d'emploi / Traducción de las Instrucciones originales / Tradução das Instruções Originais / Traduzione delle istruzioni originali / Μετάφραση των πρωτότυπων οδηγιών / Tłumaczenie instrukcji oryginalnej / Переклад оригінальної інструкції / Traduce-rea instructiunilor originale / Tradução das Instruções Originais / Original-Anleitung / Original Instructions.

Made in China

Країна походження: Китай

EU ADEO Services - 135 Rue Sadi Carnot - CS00001 - 59790 RONCHIN - FRANCE

UA Виробник: ТОВ "Адео Сервісез С.А.", вул. Сади Карно, CS 00001, 59790 Роншен, Франція. Імпортер: ТОВ "Леруа Мерлен Україна", 04201 Україна, м. Київ, вул. Полярна 17А, +380 44 498 46 00. Імпортер приймає претензії від споживачів щодо товару, а також проводить його ремонт, технічне і гарантійне обслуговування

BR IMPORTADO E DISTRIBUÍDO POR: LEROY MERLIN COMPANHIA BRASILEIRA DE BRICOLAGEM CNPJ: 01.438.784/0001-05 Rua Pascoal Pais, nº. 525, 6º andar, cj 61 a 64 - Vila Cordeiro, São Paulo - SP CEP: 04581-060 CALM (Central de Atendimento Leroy Merlin) Capitais 4020-5376 Demais Regiões 0800-0205376

ZA Imported by Adeo South Africa (PTY) LTD T/A Leroy Merlin, Hosted in Leroy Merlin Fourways Store 35 Roos Street, Witkoppen Ext 97, Sandton, 2191 Johannesburg, Gauteng, South Africa. Tel: +27 10 493 8000 Email: contact@leroymerlin.co.za.

Batch no: XXXXXXXXXX

批次信息详见备注, 红字不印刷