

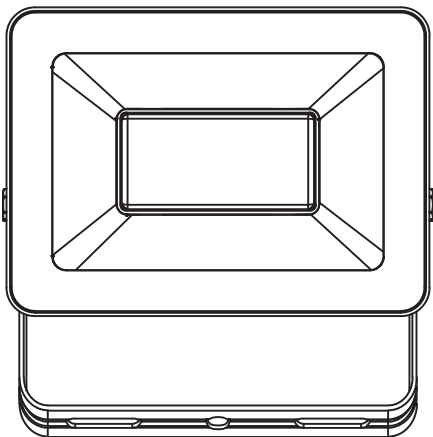

YONKERS

EAN : 3276007463873_3276007463897_3276007463927_3276007463965_3276007463996_3276007464078_3276007464108_3276007464122



2/2



2022/11-V01

FR Manuel d'Instructions

EL Εγχειρίδιο Οδηγιών

DE Anleitung Handbuch

ES Manual de Instrucciones

PL Instrukcja Obsługi

EN Instructions Manual

PT Manual de Instruções

UA Інструкція з Експлуатації

IT Manuale di Istruzioni

RO Manual de Instrucțiuni

* Garantie 5 ans / 5 años de garantía / Garantia de 5 anos / Garanzia 5 Anni / Εγγύηση 5 ετών / Gwarancja 5-letnia / Гарантія 5 років / Garanție 5 ani / Garantia de 5 anos / 5-year-guarantee

** réparable / reparable / reparável / riparabile / διορθώσιμος / naprawiany / ремонтний / reparabil / repairable



Montage / Montaje / Montagem / Montaggio / Συναρμολόγηση / Montaž / Збірка /
Ansamblu / Montaje / Montage / Assembly

3 → 7



Utilisation / Utilizaçión / UtilizaçãO / Uso / Χρήση / Użytkowanie /
Використовуйте / Utilizați / Utilizare / Verwenden Sie / Use



1 / 2



FR : CARACTERISTIQUES TECHNIQUES / ES : CARACTERÍSTICAS TÉCNICAS / PT : CARACTERÍSTICAS
TÉCNICAS / IT : CARATTERISTICHE TECNICHE / EL : ΤΕΧΝΙΚΑ ΧΑΡΑΚΤΗΡΙΣΤΙΚΑ / PL : DANE
TECHNICZNE / UA : ТЕХНІЧНІ ХАРАКТЕРИКИ / RO : CARACTERISTI TEHNICE / DE : TECHNISCHE
MERKMALE / EN : TECHNICAL CHARACTERISTICS



1



2



5



6



7

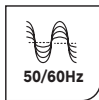

8



26



30



36



37

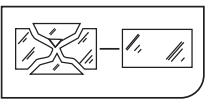

FR : PIÈCE RÉPARABLE / ES : PIEZA REPARABLE / PT : PARTE REPARÁVEL / IT : PARTE RIPARABILE / EL :
ΕΠΙΣΚΕΥΑΣΙΜΟ ΜΕΡΟΣ / PL : CZĘŚĆ NADAJĄCA SIĘ DO NAPRAWY / UA : ЧАСТИНА, що підлягає
ремонту / RO : PIEȘĂ REPARABILĂ / DE : REPARIERBARES TEIL / EN : REPAIRABLE PART



19



20

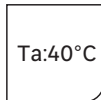

Ta:40°C



10

FR Ce produit contient une source lumineuse de classe d'efficacité énergétique D .

ES Este producto contiene una bombilla de clase de eficiencia D .

DE Dieses Produkt enthält eine Leuchte der Energieeffizienzklasse D .

PT Este produto contém uma fonte de luz de eficiência energética de classe D .

IT Questo prodotto contiene una sorgente luminosa di classe di efficienza energetica D .

EL Αυτό το προϊόν περιέχει πηγή φωτός κατηγορίας ενεργειακής απόδοσης D .



PL Niniejszy produkt zawiera źródło światła klasy efektywności energetycznej D .

UA Данное изделие содержит источник света класса энергоэффективности D .

RO Acest produs conține o sursă de lumină din clasa de eficiență energetică D .

EN This product includes a light of the energy efficiency class D .

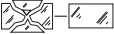
1. Warning symbols

$T_a:40^{\circ}\text{C}$	Ambient temperature at a maximum of 40 C
	Replace any cracked protective shield
	Caution, risk of electric shock

2. Appliance specifications

TECHNICAL CHARACTERISTICS					
EAN CODE	3276007463873	3276007463897/ 3276007464078	3276007463927/ 3276007464108	3276007463965/ 3276007464122	3276007463996
Model	BD05C-YON-10-G	BD05C-YON-20-G/ BD05C-YON-20-W	BD05C-YON-30-G/ BD05C-YON-30-W	BD05C-YON-50-G/ BD05C-YON-50-W	BD05C-YON-100-G
Rated wattage	10W	20W	30W	50W	100W
Weight	0.180kg	0.311kg	0.418kg	0.688kg	1.367kg
Dimension	88*101*48 mm	108*134*52 mm	134*158*52 mm	158*202*58 mm	202*276*62 mm
Maximum projected area of the floodlight	0.0165m ²	0.0251m ²	0.0337m ²	0.0467m ²	0.0558m ²
Operation position	For outdoor use only	For outdoor use only	For outdoor use only	For outdoor use only	For outdoor use only
Rated Voltage	220-240V	220-240V	220-240V	220-240V	220-240V
Rated frequency	50/60Hz	50/60Hz	50/60Hz	50/60Hz	50/60Hz
Protection class	Class I	Class I	Class I	Class I	Class I
Range of mounting heights	2-3m	2-3m	2-3m	2-3m	2-3m
Input Current	53mA	108mA	131mA	217mA	440mA
Power factor	0.5	0.5	0.9	0.9	0.9
IP number	65	65	65	65	65
Limitation of use indoors and outdoor	outdoor	outdoor	outdoor	outdoor	outdoor



A

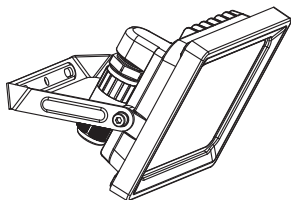

*



*Utiliser les vis et chevilles adaptées à votre support - Utilice tornillos y tacos adecuados para el soporte - Utilize buchas e parafusos adaptados à superfície de instalação - Utilizzare viti e tasselli adeguati al proprio supporto - Χρησιμοποιήστε τις κατάλληλες βίδες και ούπα για τον τοίχο σας - Taşıyıcıya uygun vida ve dübel kullanın - Используйте шурупы/крепления, которые подходят к основанию, к которому они будут крепиться - Використовуйтевинти та штифти, що підходять для поверхні, на яку Ви монтуєте ролет/жалюзі - Należy korzystać ze śrub i kołków przystosowanych do nośnika - Utilizați șuruburile și diblurile adecvate suportului dvs - Use screws and dowels suited to your backing.

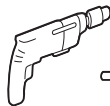
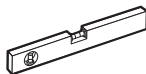

Ø6mm





1

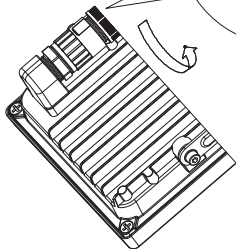
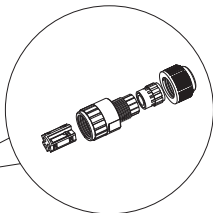
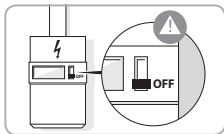

2

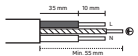
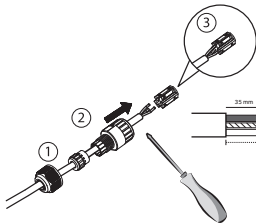

N = Blue/Bleu/Azul/Azül/Bla/Mnole/Niebieski/Cиний/Albastru

⊕ = Green and yellow/Vert et jaune/Verde y amarillo/Verde e giallo/
Продовж колірково/Зielony i żółty/Зеленый і жовтий/Verde-galben

L = Brown/Marron/Marrón/Castanho/Marrone/Кафє/Бразовый/Коричневий/Мара

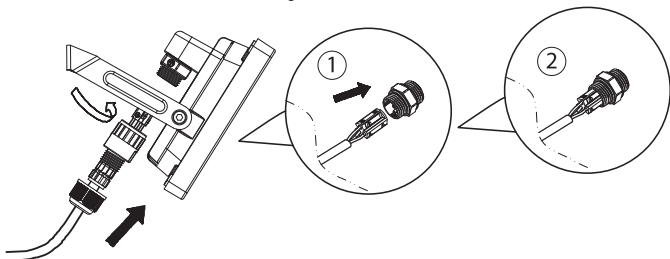

3

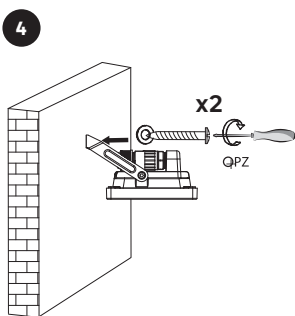
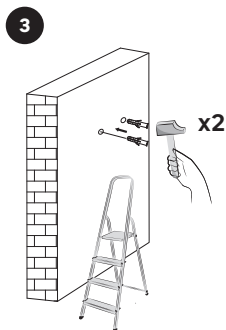
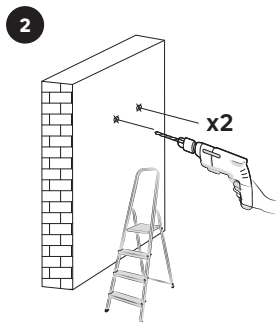
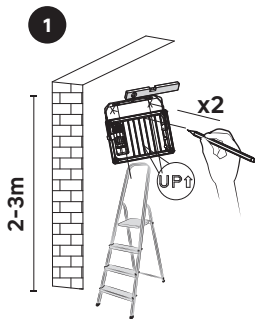

4

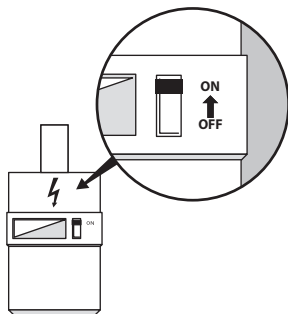
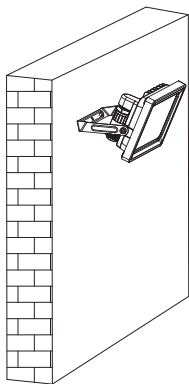

1

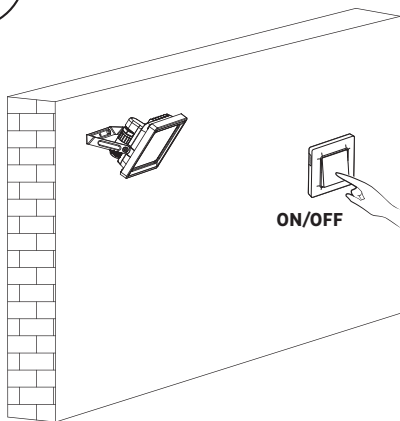



1



2

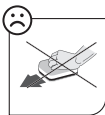

3



- FR** Ce produit est recyclable. S'il ne peut plus être utilisé, veuillez l'apporter dans un centre de recyclage de déchets.
- ES** Este producto es reciclable. Si ya no se puede usar, llévelo a un centro de reciclaje de residuos.
- PT** Este produto é reciclável. Se deixar de o utilizar, entregue-o num centro de reciclagem de resíduos.
- IT** Questo prodotto può essere riciclato. Se deve essere smaltito, portalo presso un centro di riciclaggio.
- EL** Αυτό το προϊόν είναι ανακυκλώσιμο. Εάν δεν μπορεί πλέον να χρησιμοποιηθεί, μεταφέρετε την σε κάποιο κέντρο ανακύκλωσης απορριμμάτων.
- PL** Ten produkt poddawany jest recyklingowi, kiedy przestaje być użyteczny należy dostarczyć go do punktu zbiórki odpadów.
- UA** Цей продукт може перероблятися. Якщо воно більше не є придатне для використання, здайте його в утилізаційний центр.
- RO** Acest produs este reciclabil. Dacă nu mai poate fi folosit, vă rugăm să îl aduceți într-un centru de reciclare a deșeurilor.
- BR** Este produto é reciclável. Se não puder mais ser usado, descarte em um centro de reciclagem de resíduos.
- DE** Dieses Produkt ist recycelbar. Wenn es nicht mehr verwendet werden kann, bringen Sie es bitte zum Recycling-Center.
- EN** This product is recyclable. If it cannot be used anymore, please take it to waste recycling centre.



Traduction de la version originale du mode d'emploi / Traducción de las Instrucciones originales / Tradução das Instruções Originais / Traduzione delle istruzioni originali / Μετάφραση των πρωτότυπων οδηγιών / Tłumaczenie instrukcji oryginalnej / Переклад оригінальної інструкції / Traduce-rea instructiunilor originale / Tradução das Instruções Originais / Original-Anleitung / Original Instructions.

Made in China

Країна походження: Китай

EU ADEO Services - 135 Rue Sadi Carnot - CS00001 - 59790 RONCHIN - FRANCE

UA Виробник: ТОВ "Адео Сервісез С.А.", вул. Сади Карно, CS 00001, 59790 Роншен, Франція. Імпортер: ТОВ "Леруа Мерлен Україна", 04201 Україна, м. Київ, вул. Полярна 17А, +380 44 498 46 00. Імпортер приймає претензії від споживачів щодо товару, а також проводить його ремонт, технічне і гарантійне обслуговування

BR IMPORTADO E DISTRIBUÍDO POR: LEROY MERLIN COMPANHIA BRASILEIRA DE BRICOLAGEM CNPJ: 01.438.784/0001-05 Rua Pascoal Pais, nº. 525, 6º andar, cj 61 a 64 - Vila Cordeiro, São Paulo - SP CEP: 04581-060 CALM (Central de Atendimento Leroy Merlin) Capitais 4020-5376 Demais Regiões 0800-0205376

ZA Imported by Adeo South Africa (PTY) LTD T/A Leroy Merlin, Hosted in Leroy Merlin Fourways Store 35 Roos Street, Witkoppen Ext 97, Sandton, 2191 Johannesburg, Gauteng, South Africa. Tel: +27 10 493 8000 Email: contact@leroymerlin.co.za.