

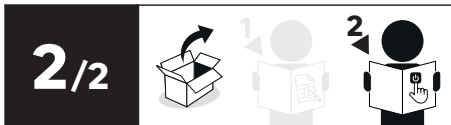

Seffner

EAN CODE: 3276007464047

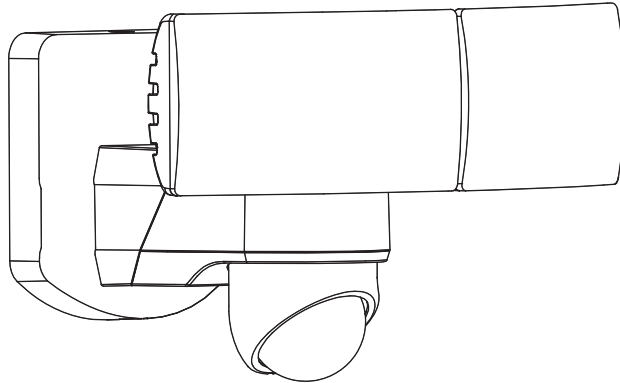

2022/03 V02

FR Manuel d'Instructions

ES Manual de Instrucciones

PT Manual de Instruções

IT Manuale di Istruzioni

EL Εγχειρίδιο Οδηγιών

PL Instrukcja Obsługi

UA Інструкція ЗЕксплуатації

RO Manual de Instrucțiuni

EN Instructions Manual

* Garantie 5 ans / 5 años de garantía / Garantia de 5 anos / Garanzia 5 Anni / Εγγύηση 5 ετών / Gwarancja 5-letnia / Гарантія 5 років / Garanție 5 ani / Garantia de 5 anos/5-year-guarantee

** réparable / repairable / reparável / riparabile / διορθώσιμος / naprawiany / ремонтний / reparabil / repairable



Montage / Montaje / Montagem / Montaggio / Συναρμολόγηση / Montaż / Збірка / Montaj /
Assembly



2 → 6



Utilisation / Utilización / Utilização / Uso / Χρήση / Użytkowanie /
Використання / Utilizare / Use



7 → 10



1/2



FR : CARACTERISTIQUES TECHNIQUES / ES : CARACTERÍSTICAS TÉCNICAS / PT : CARACTERÍSTICAS TÉCNICAS /
IT : CARATTERISTICHE TECNICHE / EL : ΤΕΧΝΙΚΑ ΧΑΡΑΚΤΗΡΙΣΤΙΚΑ / PL : DANE TECHNICZNE / UA : ТЕХНІЧНІ ХАРАКТЕРИКИ
/ RO : CARACTERISTI TECHICE / BR : CARACTERÍSTICAS TÉCNICAS / EN : TECHNICAL CHARACTERISTICS



1

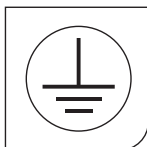

2



6

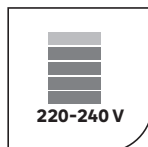

7

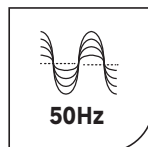

8

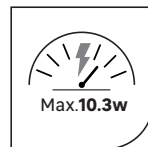

9



10



12

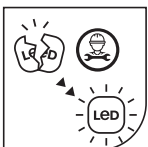

19

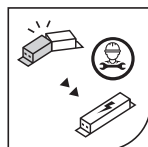

20



26



30

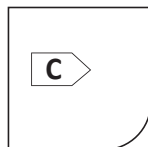

33



FR Ce produit contient une source lumineuse de classe d'efficacité énergétique C.

ES Este producto contiene una bombilla de clase de eficiencia C.

PT Este produto contém uma fonte de luz de eficiência energética de classe C.

IT Questo prodotto contiene una sorgente luminosa di classe di efficienza energetica C.

EL Αυτό το προϊόν περιέχει πηγή φωτός κατηγορίας ενεργειακής απόδοσης C.

PL Niniejszy produkt zawiera źródło światła klasy efektywności energetycznej C.

UA Цей продукт містить джерело світла класу енергоефективності C.

RO Данное изделие содержит источник света класса энергоэффективности C.

DE Dieses Produkt enthält eine Lichtquelle der Energieeffizienzklasse C.

EN This product includes a light of the energy efficiency class C.

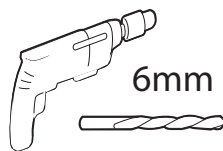
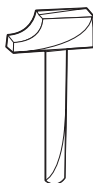
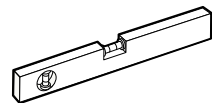
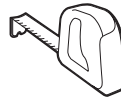
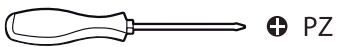
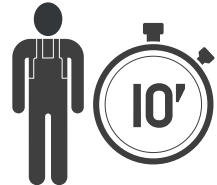
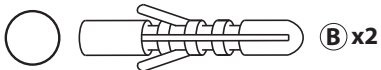
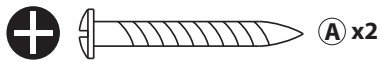
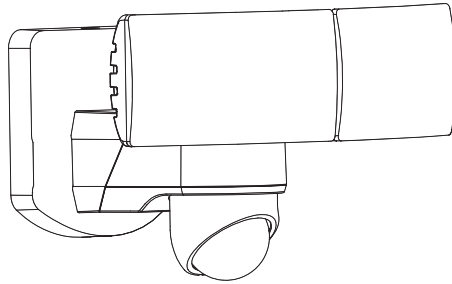



1

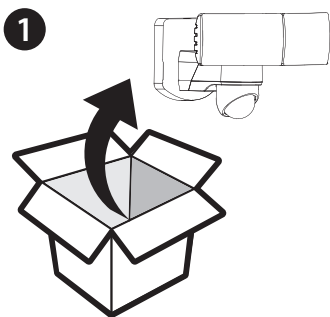

2

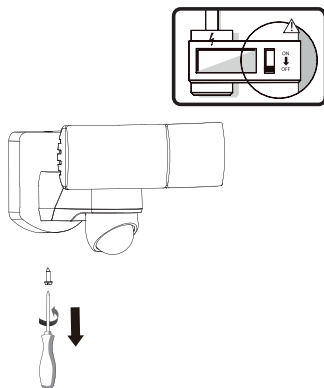

3

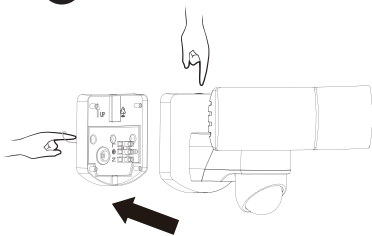

4

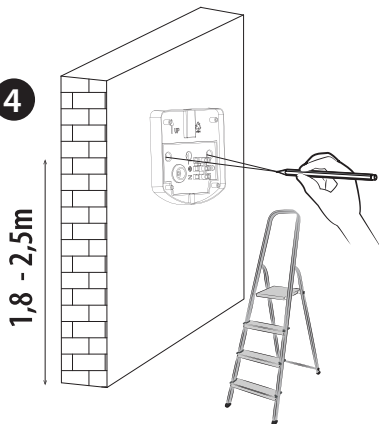

2

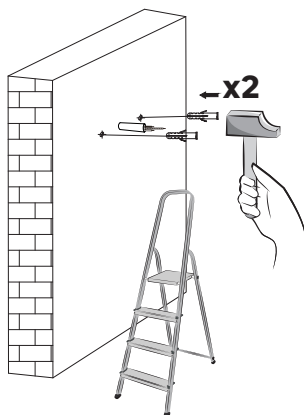
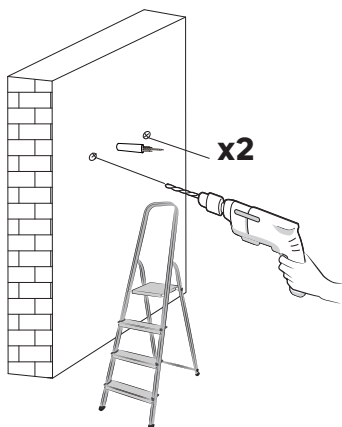

3

3

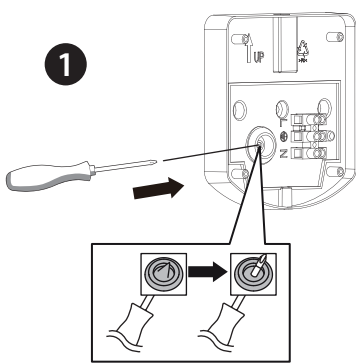

2

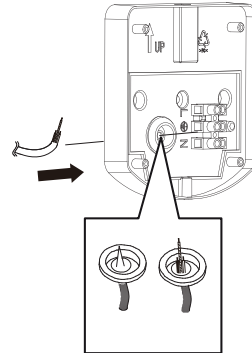

3

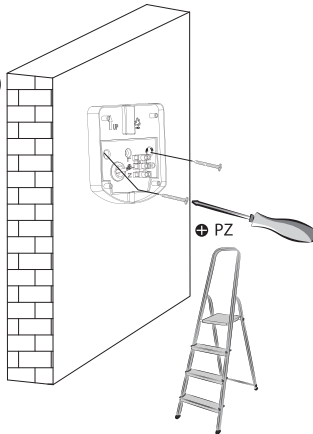

4

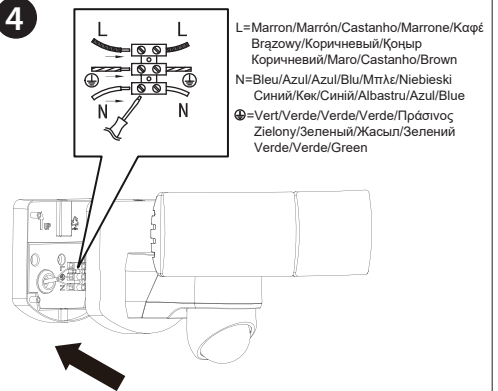

4

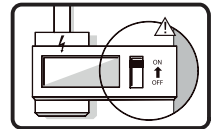
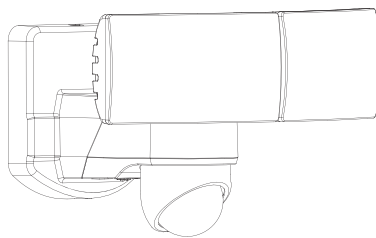



1

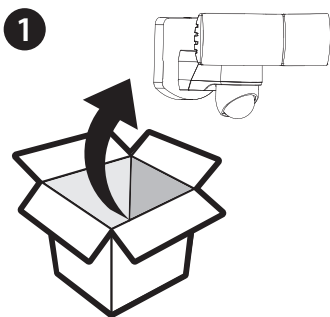

2

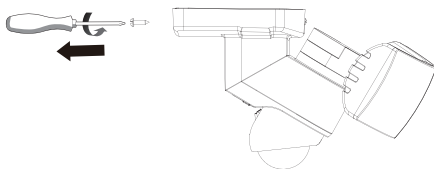

3

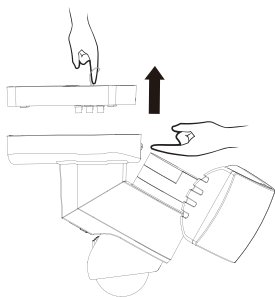

4

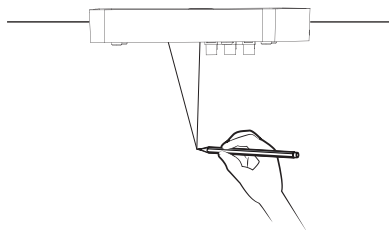

2

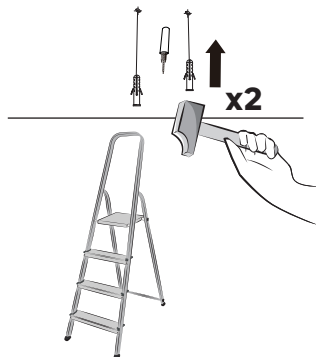
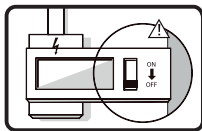
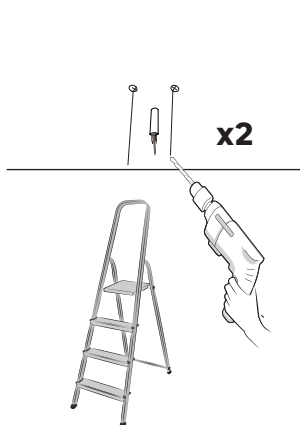

3

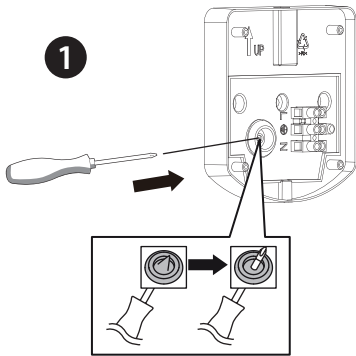

2

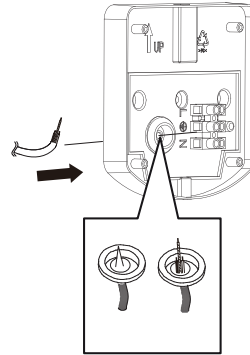

3

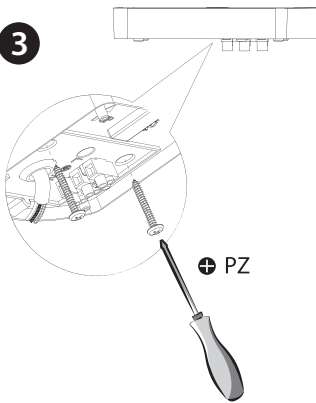

4

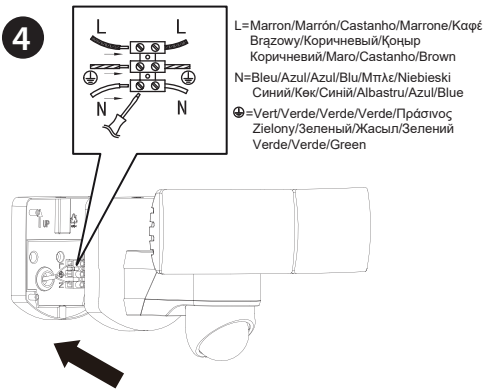

4

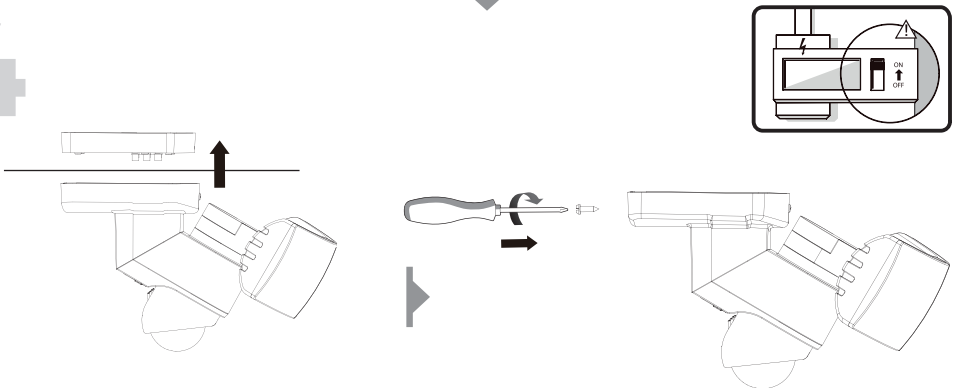



1

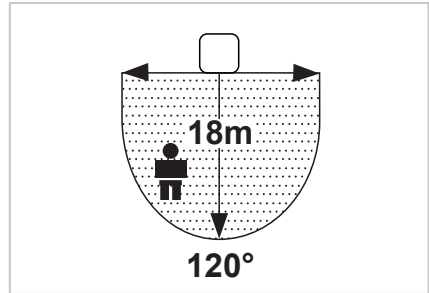
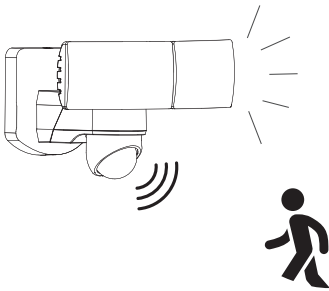
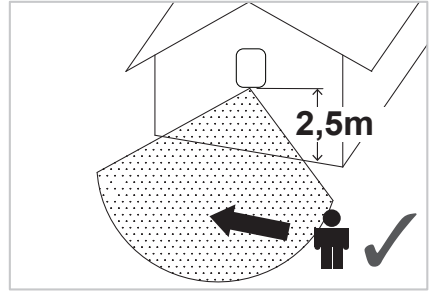

2

TIME

TEST **10 MIN**
1 MIN **3 MIN**

1min 3min 10min

DISTANCE

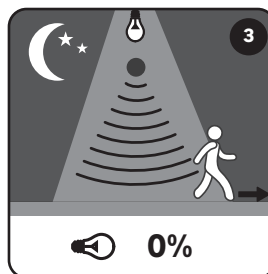
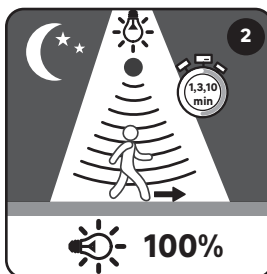
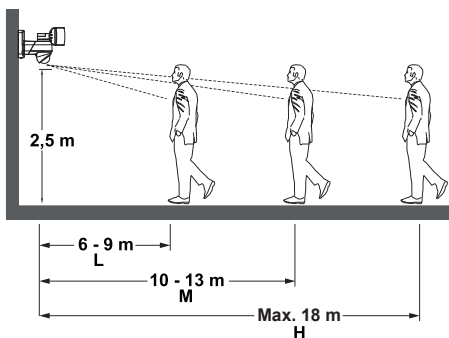
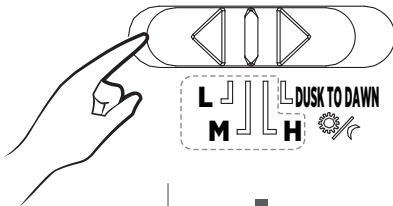

3

DISTANCE 

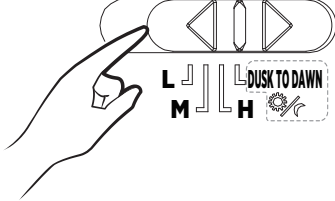

L M H DUSK TO DAWN

1  15%

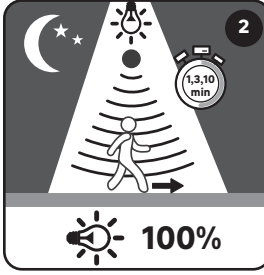
2  100%

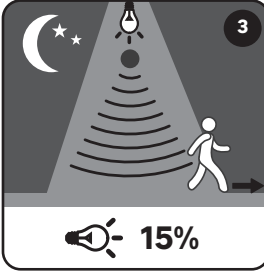
3  15%

4

TIME 

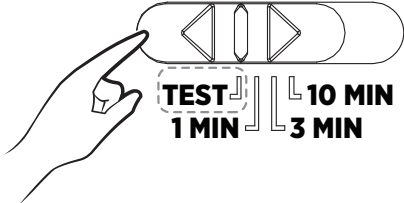

TEST 1 MIN 3 MIN 10 MIN

 5s





5

De-activate sensor override mode Deaktivieren Sie den Sensor-Override-Modus/Désactiver le mode prioritaire du capteur
Sensor-override-modus deaktivieren/Disattivare la modalità di esclusione del sensore/Desactivar el modo de anulación del sensor
Kapcsolja ki az érzékelő felülírási módját/Dezaktywuj tryb nadpisania czujnika

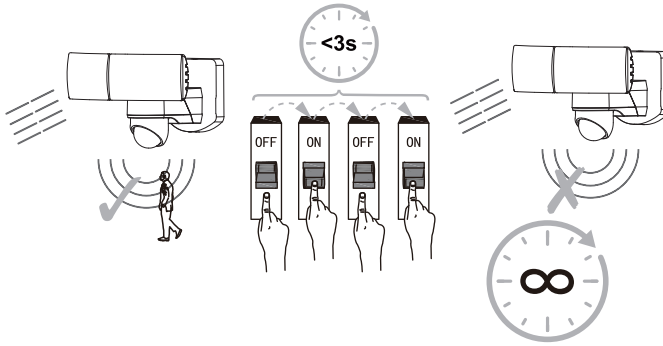

Activate sensor override mode Aktivieren Sie den Sensor-Override-Modus/Activer le mode prioritaire du capteur
Activeer de sensoroverride-modus/Attiva la modalità di override del sensore/Activar el modo de anulación del sensor
Aktiválja az érzékelő felülírási módját/Aktywuj tryb nadpisania czujnika

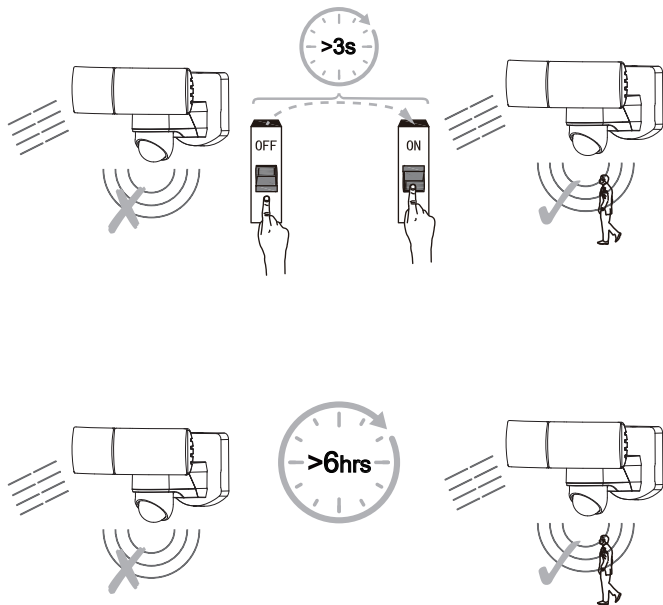



Made in China

Traduction de la version originale du mode d'emploi / Traducción de las Instrucciones originales / Tradução das Instruções Originais / Traduzione delle istruzioni originali / Μετάφραση των πρωτότυπων οδηγιών / Tłumaczenie instrukcji oryginalnej / Переклад оригінальної інструкції / Traducerea instrucțiunilor originale / Tradução das Instruções Originais / Original Instructions

ADEO Services - 135 Rue Sadi Carnot - CS 00001 - 59790 RONCHIN - France

UA Виробник: ТОВ "Адео Сервісез С.А.", вул. Саді Карно, CS 00001, 59790 Роншен, Франція.
Імпортер: ТОВ "Леруа Мерлен Україна", 04201 Україна, м.Київ, вул. Полярна 17А, +380 44 498 46 00.
Імпортер приймає претензії від споживачів щодо товару, а також проводить його еремент, технічне і гарантійне обслуговуваня

BR IMPORTADO E DISTRIBUÍDO POR:
LEROY MERLIN COMPANHIA BRASILEIRA DE BRICOLAGEM CNPJ: 01.438.784/0001-05
Rua Pascoal Pais, nº. 525, 6º andar, cj 61 a 64 - Vila Cordeiro, São Paulo - SP CEP: 04581-060
CALM (Central de Atendimento Leroy Merlin)
Capitais 4020-5376 Demais Regiões 0800-0205376
IMAGEM ILUSTRATIVA

ZA Imported by Adeo South Africa (PTY) LTD T/A Leroy Merlin
Leroy Merlin Greenstone Store
Corner Blackrock Street and Stoneridge Drive, Greenstone Park Ext 2, Edenvale, 1610 Johannesburg, Gauteng, South Africa