

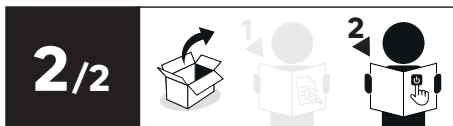

Quito

EAN CODE: 3276007464238

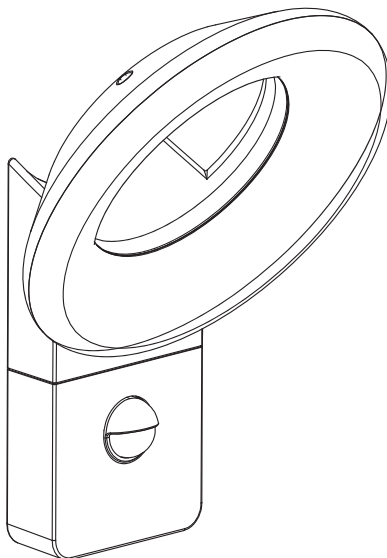

2022/03 V02

**FR** Manuel d'Instructions

**ES** Manual de Instrucciones

**PT** Manual de Instruções

**IT** Manuale di Istruzioni

**EL** Εγχειρίδιο Οδηγιών

**PL** Instrukcja Obsługi

**UA** Інструкція З Експлуатації

**RO** Manual de Instrucțiuni

**EN** Instructions Manual

\* Garantie 5 ans / 5 años de garantía / Garantia de 5 anos / Garanzia 5 Anni / Εγγύηση 5 ετών / Gwarancja 5-letnia / Гарантія 5 років / Garanție 5 ani / Garantia de 5 anos/5-year-guarantee

\*\* réparable / repairable / reparável / riparabile / διορθώσιμος / naprawiany / ремонтний / reparabil / repairable



Montage / Montaje / Montagem / Montaggio / Συναρμολόγηση / Montaž / Збірка / Montaj /  
Assembly



2 → 5



Utilisation / Utilización / Utilização / Uso / Χρήση / Użytkowanie /  
Використання / Utilizare / Use



6 → 8



1/2



FR : CARACTERISTIQUES TECHNIQUES / ES : CARACTERÍSTICAS TÉCNICAS / PT : CARACTERÍSTICAS TÉCNICAS /  
IT : CARATTERISTICHE TECNICHE / EL : ΤΕΧΝΙΚΑ ΧΑΡΑΚΤΗΡΙΣΤΙΚΑ / PL : DANE TECHNICZNE / UA : ТЕХНІЧНІ ХАРАКТЕРИКИ  
/ RO : CARACTERISTI TECHICE / BR : CARACTERÍSTICAS TÉCNICAS / EN : TECHNICAL CHARACTERISTICS



1

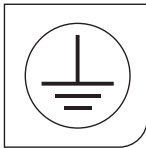

2



6

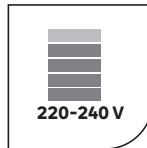

7

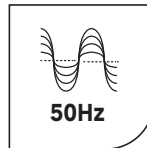

8

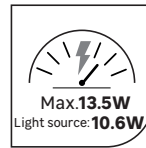

9

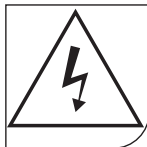

10



12

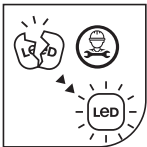

19

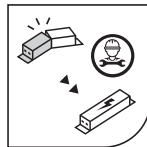

20

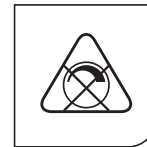

26

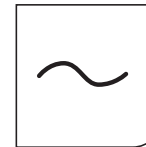

30

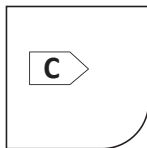

33



**FR** Ce produit contient une source lumineuse de classe d'efficacité énergétique C.

**ES** Este producto contiene una bombilla de clase de eficiencia C.

**PT** Este produto contém uma fonte de luz de eficiência energética de classe C.

**IT** Questo prodotto contiene una sorgente luminosa di classe di efficienza energetica C.

**EL** Αυτό το προϊόν περιέχει πηγή φωτός κατηγορίας ενεργειακής απόδοσης C.

**PL** Niniejszy produkt zawiera źródło światła klasy efektywności energetycznej C.

**UA** Цей продукт містить джерело світла класу енергоефективності C.

**RO** Данное изделие содержит источник света класса энергоэффективности C.

**DE** Dieses Produkt enthält eine Lichtquelle der Energieeffizienzklasse C.

**EN** This product includes a light of the energy efficiency class C.

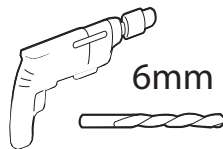
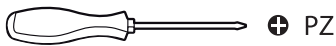
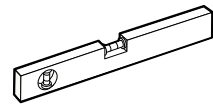
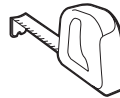
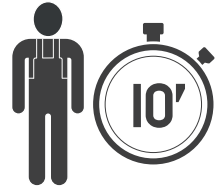
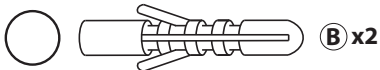
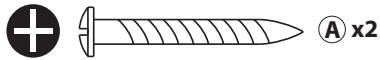
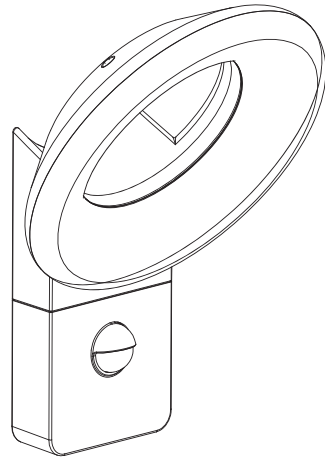



1

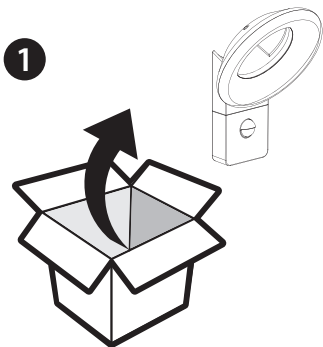

2

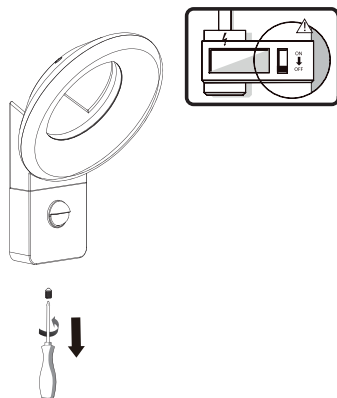

3

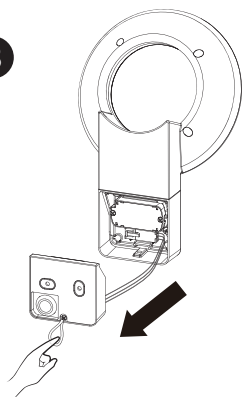

4

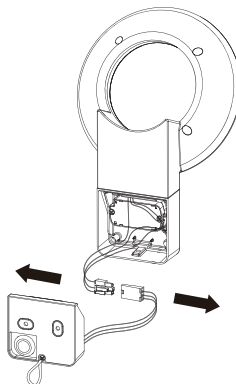

2

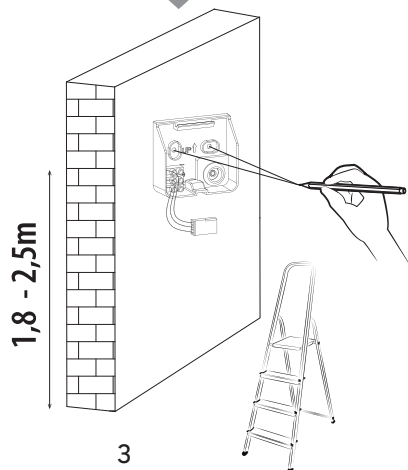

# 3

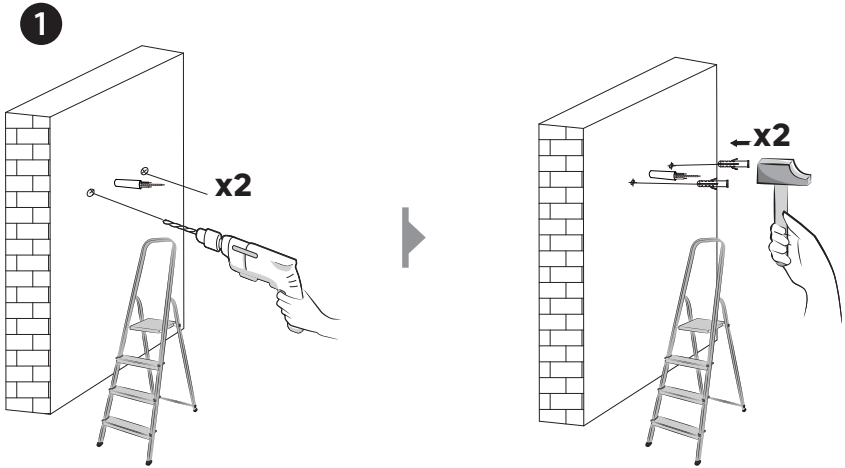

# 2

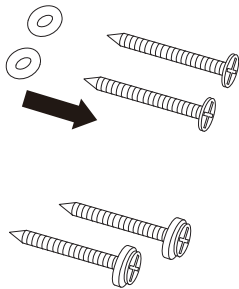

# 3

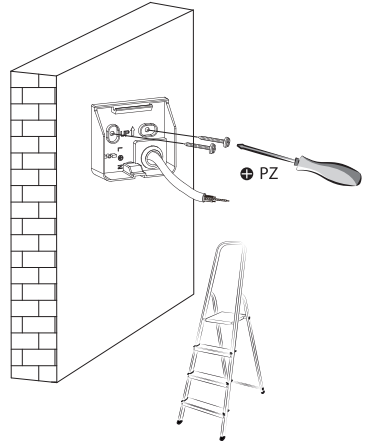

# 4

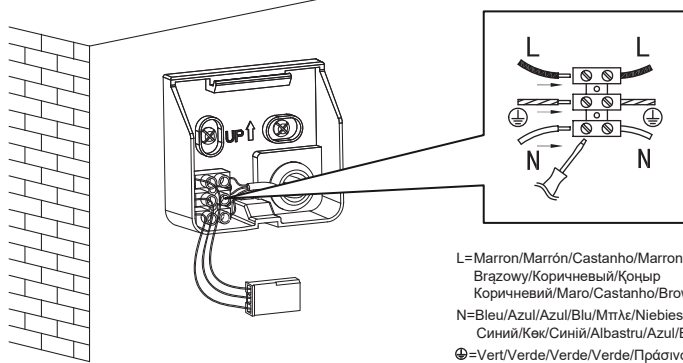

L=Marron/Marrón/Castanho/Marrone/Καφέ  
Brazowy/Коричневый/Қоңыр  
Коричневий/Maro/Castanho/Brown  
N=Bleu/Azul/Azul/Blu/Мпλε/Niebieski  
Синий/Көк/Синий/Albastru/Azul/Blue  
⊕=Vert/Verde/Verde/Verde/Πράσινοϛ  
Zielony/Зеленый/Жасыл/Зеленый  
Verde/Verde/Green

5

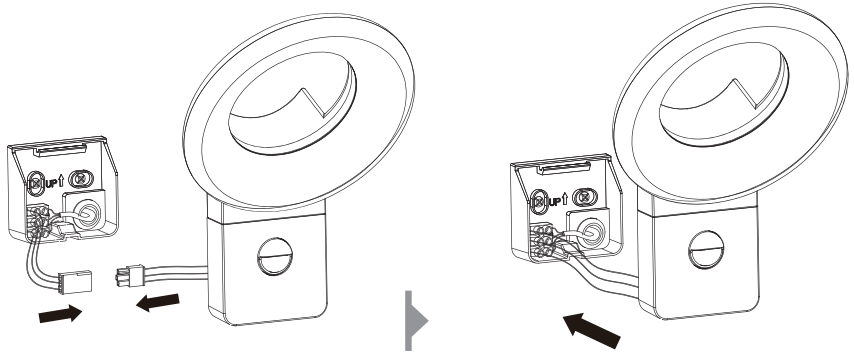

6

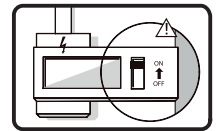
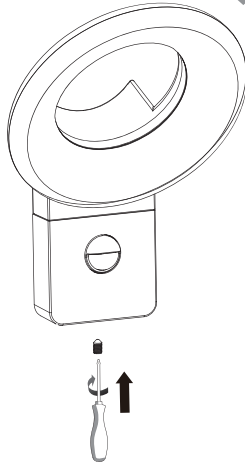



1

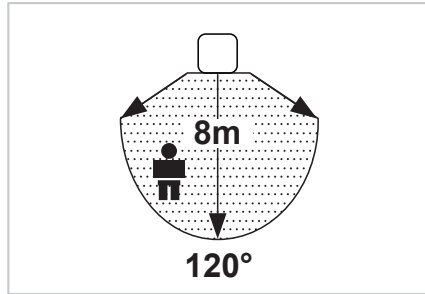
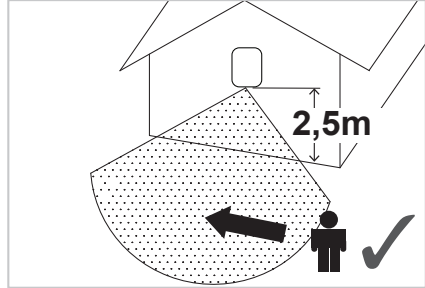

# 2

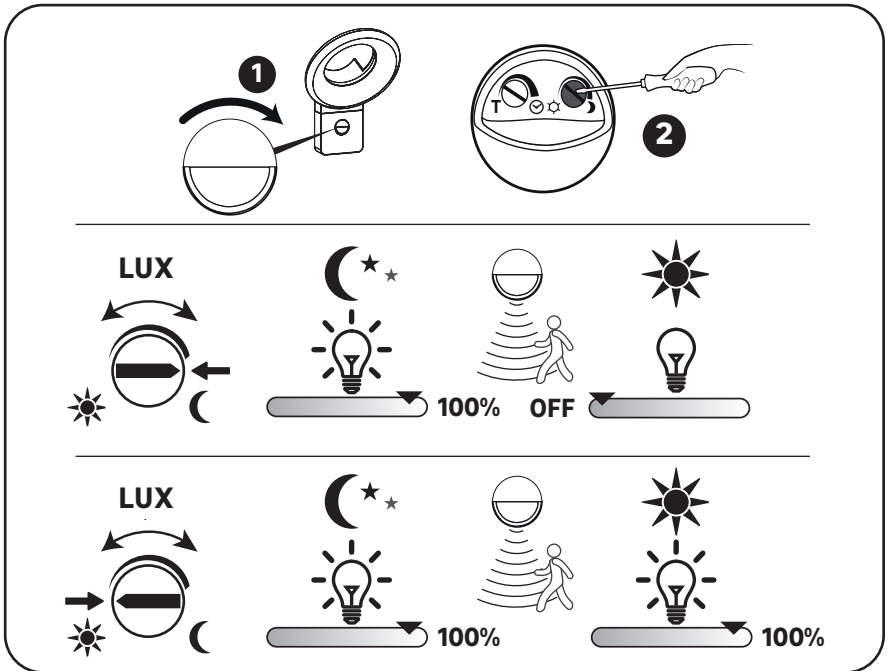
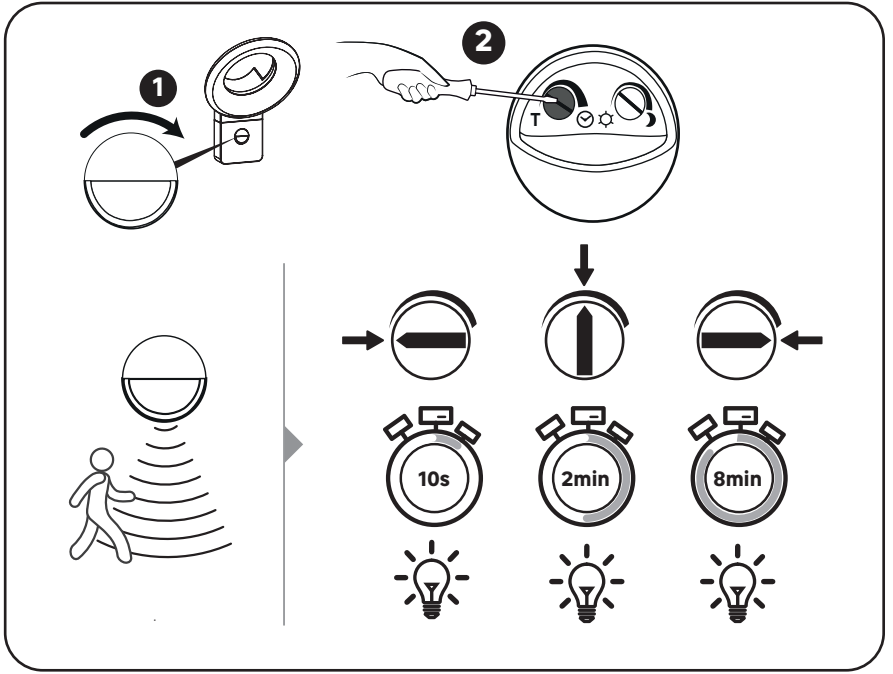



# 3

**De-activate sensor override mode** Deaktivieren Sie den Sensor-Override-Modus/Désactiver le mode prioritaire du capteur  
Sensor-override-modus deaktivieren/Disattivare la modalità di esclusione del sensore/Desactivar el modo de anulación del sensor  
Kapcsolja ki az érzékelő felülírási módját/Dezaktywuj tryb nadpisania czujnika

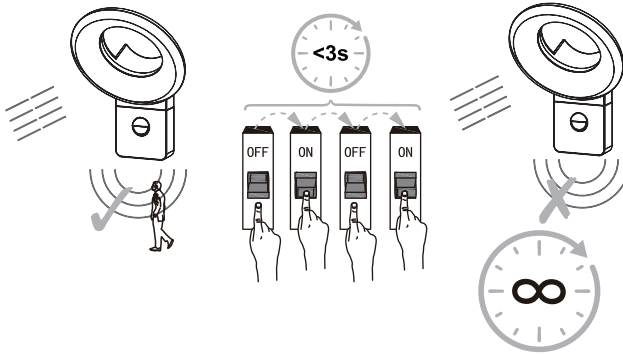

**Activate sensor override mode** Aktivieren Sie den Sensor-Override-Modus/Activer le mode prioritaire du capteur  
Activer de sensoroverride-modus/Attiva la modalità di override del sensore/Activar el modo de anulación del sensor  
Aktiválja az érzékelő felülírási módját/Aktywuj tryb nadpisania czujnika

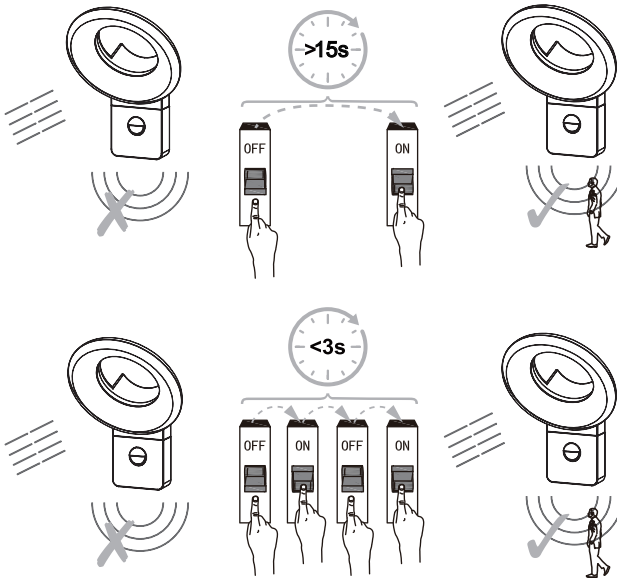



Made in China

Traduction de la version originale du mode d'emploi / Traducción de las Instrucciones originales / Tradução das Instruções Originais / Traduzione delle istruzioni originali / Μετάφραση των πρωτότυπων οδηγιών / Tłumaczenie instrukcji oryginalnej / Переклад оригінальної інструкції / Traducerea instrucțiunilor originale / Tradução das Instruções Originais / Original Instructions

---

### ADEO Services - 135 Rue Sadi Carnot - CS 00001 - 59790 RONCHIN - France

**UA** Виробник: ТОВ "Адео Сервісез С.А.", вул. Саді Карно, CS 00001, 59790 Роншен, Франція.  
Імпортер: ТОВ "Леруа Мерлен Україна", 04201 Україна, м.Київ, вул. Полярна 17А, +380 44 498 46 00.  
Імпортер приймає претензії від споживачів щодо товару, а також проводить його еремент, технічне і гарантійне обслуговуваня

**BR** IMPORTADO E DISTRIBUÍDO POR:  
LEROY MERLIN COMPANHIA BRASILEIRA DE BRICOLAGEM CNPJ: 01.438.784/0001-05  
Rua Pascoal Pais, nº. 525, 6º andar, cj 61 a 64 - Vila Cordeiro, São Paulo - SP CEP: 04581-060  
CALM (Central de Atendimento Leroy Merlin)  
Capitais 4020-5376 Demais Regiões 0800-0205376  
IMAGEM ILUSTRATIVA

**ZA** Imported by Adeo South Africa (PTY) LTD T/A Leroy Merlin  
Leroy Merlin Greenstone Store  
Corner Blackrock Street and Stoneridge Drive, Greenstone Park Ext 2, Edenvale, 1610 Johannesburg, Gauteng, South Africa