

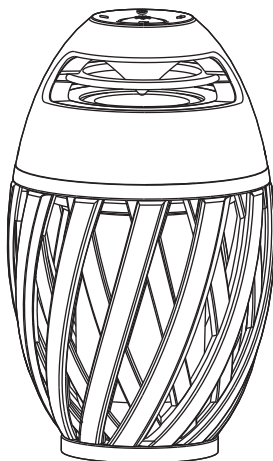

Isken

EAN : 3276007468830



2/2



2023-01-V02

FR Manuel d'Instructions

ES Manual de Instrucciones

PT Manual de Instruções

IT Manuale di Istruzioni

EL Εγχειρίδιο Οδηγιών

PL Instrukcja Obsługi

UA Інструкція з Експлуатації

RO Manual de Instrucțiuni

DE Anleitung Handbuch

EN Instructions Manual

*Année de garantie / años de garantía / Ano de garantía / Anno di garanzia / Έτος εγγύησης / Rok gwarancji / Гарантія років / Anul de garanție / Año de garantía / Jahr der Garantie / Year of guarantee

** réparable / reparabile / reparável / riparabile / διορθώσιμος / naprawiany / ремонтний / reparabil / reparaturfähig / repairable



Montage / Montaje / Montagem / Montaggio / Συναρμολόγηση / Montaž / Збірка /
Montaj / Assembly



3



Utilisation / Utilización / Utilização / Uso / Χρήση / Użytkowanie /
Використання / Utilizare / Use



4 → 9

FR: CARACTERISTIQUES TECHNIQUES / ES: CARACTERÍSTICAS TÉCNICAS / PT: CARACTERÍSTICAS TÉCNICAS / IT: CARATTERIS-
TICHE TECNICHE / EL: ΤΕΧΝΙΚΑ ΧΑΡΑΚΤΗΡΙΣΤΙΚΑ / PL: DANE TECHNICZNE / UA: / RO: CARACTERISTI TECHICE / DE: TECHNISCHE
MERKMALE / EN: TECHNICAL CHARACTERISTICS



1 / 2



1



4



6



8



9



12



8h-22h
MAX**



22



23



31



34

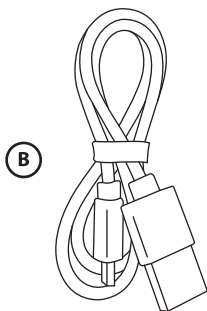
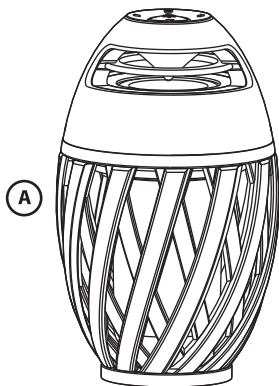



1

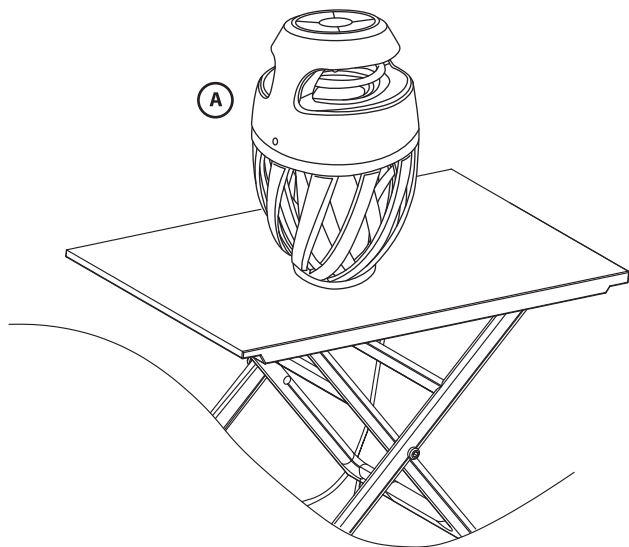



1

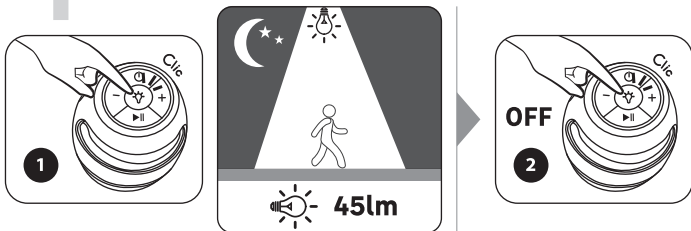

2

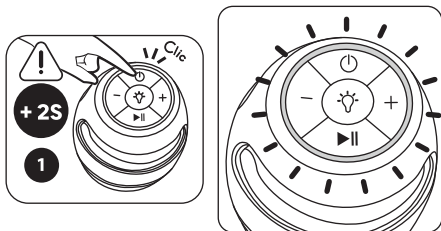

ISKEN-INSPIRE

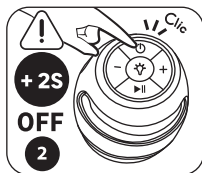

3

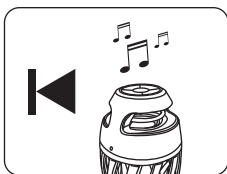
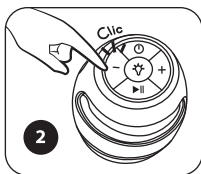
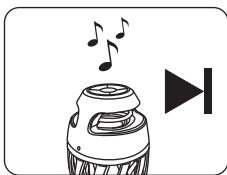
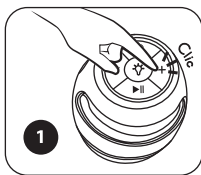

4

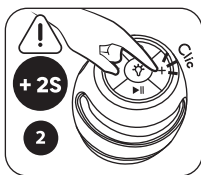
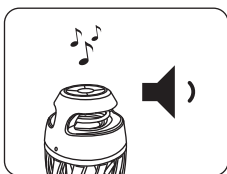
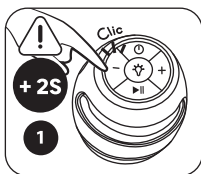

5

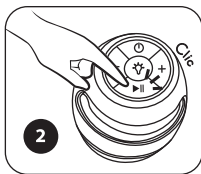
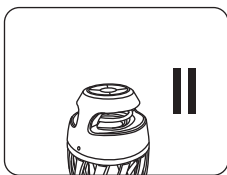
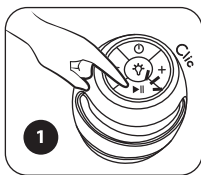

6

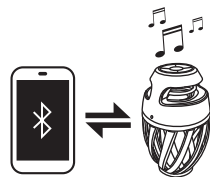
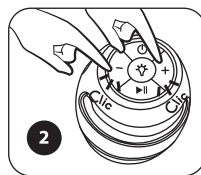
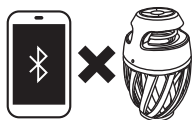
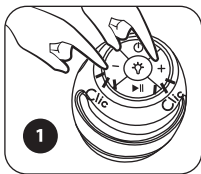
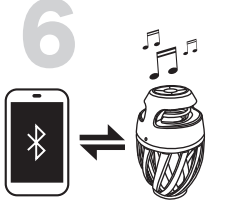

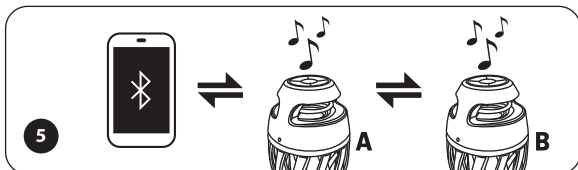
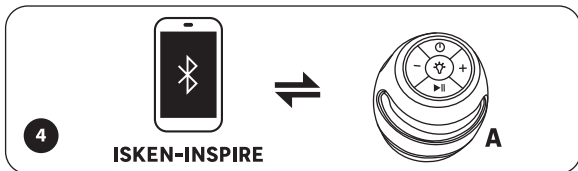
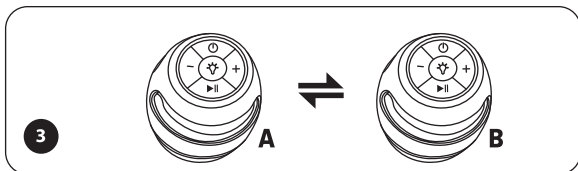
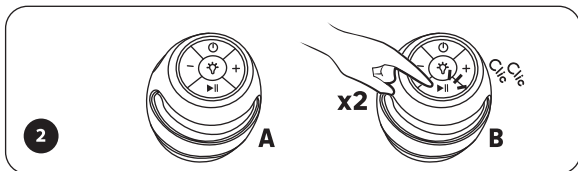
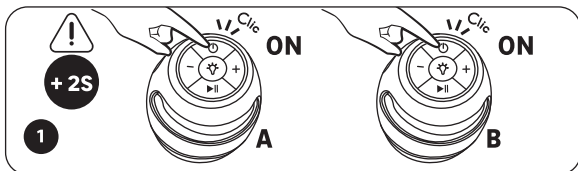

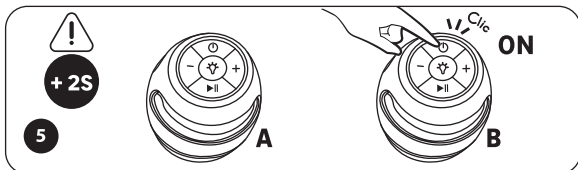
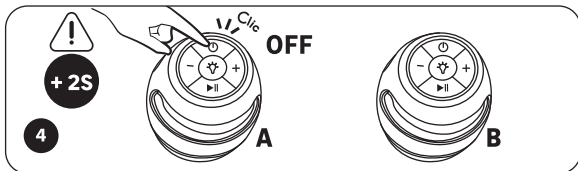
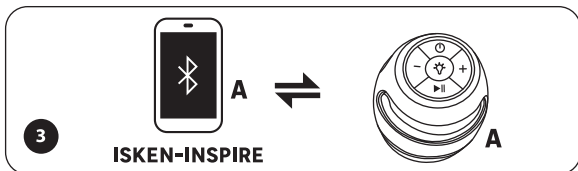
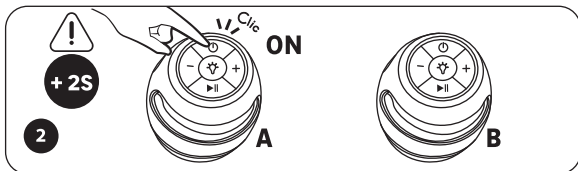
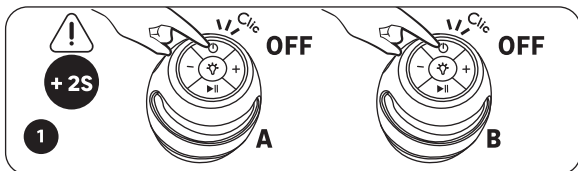

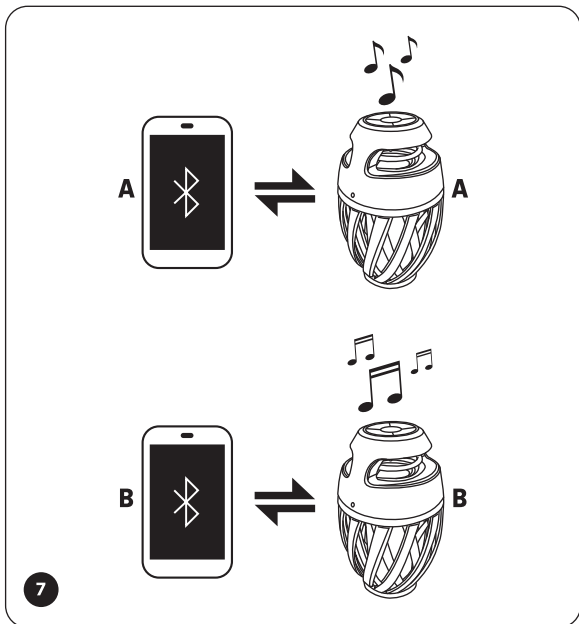
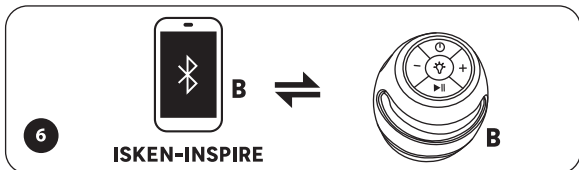



1

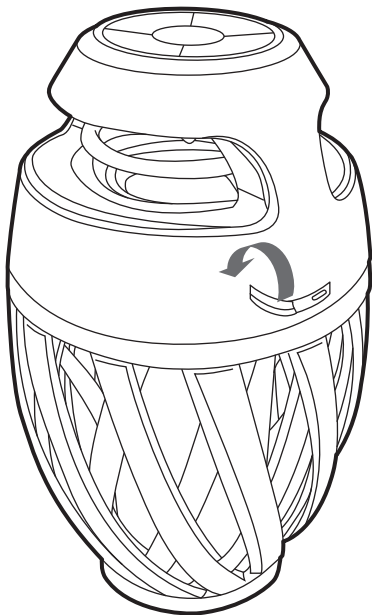

2

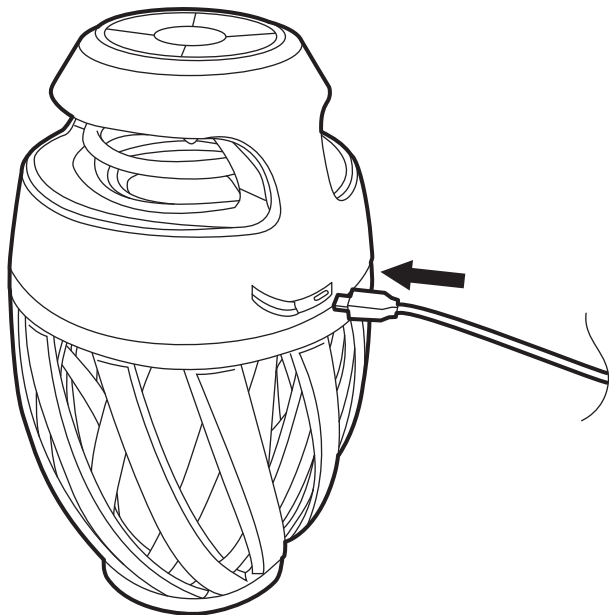



EU/EC Declaration of conformity
Déclaration UE/CE de conformité
DECLARACIÓN CE / UE DE CONFORMIDAD
Declaração CE/UE de conformidade



ENFR
ESP1

Product Model/Modèle du produit/Modelo de producto/Modelo do produto

84723581

Name and address of the manufacturer or his authorised representative/Nom et adresse du fabricant ou de son mandataire/Nombre y dirección del fabricante o de su representante autorizado/Nome e endereço do fabricante ou do seu representante autorizado

ADEO Services, 135 Rue Sadi Carnot - CS 00001 59790 RONCHIN - France

This declaration of conformity is issued under the sole responsibility of the manufacturer./La présente déclaration de conformité est établie sous la seule responsabilité du fabricant./La presente declaración de conformidad se expide bajo la exclusiva responsabilidad del fabricante./Esta declaração de conformidade é emitida sob a exclusiva responsabilidade do fabricante./

Object of the declaration/Objet de la déclaration/Objeto de la declaración/Objeto da declaração

Product Type - Descriptor/Type de produit - Description/Tipo de producto - MOBILE LIGHT USB SPEAKER 45LM FLAME EFF 16,5CM PC IP54 INSPIRE ISKEN

Product Reference/Referéncia produit/Referéncia del producto/Referéncia do produto 84723581 - EAN Code: 3276007468830 Industrial Type Design Reference: ISKENNG113

Product Brand/ Marque Produit/Producto de marca/ Marca do produto INSPIRE

Serial number coding or batch number/Codification du numéro de série ou de lot/Codificação del número de serie/Codificação do número de serie NNNNNN-DDMMYYYY-DD (NNNNNN : the last 6 digits of the EAN code, DDDMMYYYY : The date on which the order is created in the factory, DD : number of order

The object of the declaration described above is in conformity with the relevant Union harmonization legislation./L'objet de la déclaration décrit ci-dessus est conforme à la législation d'harmonisation de l'Union applicable./El objeto de la declaración descrita anteriormente es conforme a la legislación de armonización pertinente de la Unión/O objeto da declaração acima descrita está em conformidade com a legislação de harmonização da União aplicável./

References to the relevant harmonised standards used or references to the specifications in relation to which conformity is declared/Références des normes harmonisées pertinentes auxquelles ou des spécifications par rapport auxquelles la conformité est déclarée/Referencias a las normas armonizadas pertinentes utilizadas, o referencias a las especificaciones respecto a las cuales se declara la conformidad/Referências às normas harmonizadas pertinentes utilizadas ou referências às especificações para as quais a conformidade é declarada/

When applicable, the name and number of notified body number/Le cas échéant, le nom et le numéro de l'organisme notifié/Cuando correspondo, el nombre y número de laboratorio notificado que haya emitido la certificación y la referencia al documento/Quando aplicável, o nome e número do laboratório notificado que emitiu a certificação e a referência ao documento/

EN 62368-1:2014 + A11:2017
EN IEC 59015:2019 + A11:2020
EN IEC 61000-3-2:2019 + A1:2021
EN 61000-3-3:2013 + A1:2019 + A2:2021
EN 61527:2009
EN 60958-2-4:2019
ETSI EN 300 328 V2.2.2 (2019-07)
ETSI EN 301 489-1 V2.2.3 (2019-11)
ETSI EN 301 489-17 V3.2.4 (2020-09)
EN 60032:2019/A11:2020
EN 55035:2017/A11:2020
EN 62479:2019
EN 60965:2017

2014_53_EU_RED
radio equipment / Equipements radioélectriques/equipos radioelétricos/equipamentos de rádio

RoHS Directive (EU)2015/863 amending Directive 2011/65/EU
EN 62311-2:2014
EN 62311-3-1:2014
EN 62321-4-2014/A1:2017
EN 62321-5:2015
EN 62321-6:2015
EN 62321-7-1:2015
EN 62321-7-2:2017
EN 62321-8:2017
EN IEC 63000:2018

2011_65_EU_RoHS
Restriction of hazardous substances in electrical products/Restriction des substances dangereuses dans les produits électriques/Restricción de sustancias peligrosas en equipos eléctricos/Restrição de substâncias perigosas em equipamentos elétricos/

Completed, signed by and on behalf of/Complé, signé par et au nom de/Completado, firmado por y en nombre de/Completado, assinado por e em nome de/

Eric LEMONE
International Project Quality Leader

ADEO Services SAS
135 Rue Sadi Carnot
59790 Ronchin
France

Place and date of issue/Lieu et date de émission/Lugar y fecha de expedición/Local e data de emissão
Ronchin France
11/10/2022

DICHIARAZIONE DI CONFORMITÀ CE / UE
DEKLARACJA ZGODNOŚCI WE / UE
ΔΗΛΩΣΗ ΣΥΜΜΟΡΦΩΣΗΣ ΕΚ / ΕΕ
DECLARAȚIA CE / UE DE CONFORMITATE



ITFC
GRFC

Modelo de producto/Model produktů/Modello prodotto/Modèle produit/Model de produs/produsul

84723581

La presente dichiarazione di conformità è rilasciata sotto la responsabilità esclusiva del fabbricante/Ințelesura declarației prezentei sistemă asigură pe exclusivă răspundere/Modello produsentei/Πρωτοκollou κατασκευαστή (ή του εξουσιοδοτημένου αντιπροσώπου του/Reprezentarea și adreșa producătorului sau a reprezentantului său autorizat).

ADEO Services, 135 Rue Sadi Carnot - CS 00001 59790 RONCHIN - France

La presente dichiarazione di conformità è rilasciata sotto la responsabilità esclusiva del fabbricante/Ințelesura declarației prezentei sistemă asigură pe exclusivă răspundere/Modello produsentei/Πρωτοκollou κατασκευαστή (ή του εξουσιοδοτημένου αντιπροσώπου του/Reprezentarea și adreșa producătorului sau a reprezentantului său autorizat).

Objeto de la declaración/Przedmiot deklaracji/Στόχος της δήλωσης/Obiectul declarației

Tipo/Modelo de producto/Rodzaj produktu/Τύπος προϊόντος/Tipul produsului

MOBILE LIGHT USB SPEAKER 45LM FLAME EFF 16,5CM IP54 INSPIRE ISKEN

Referencia del producto/Referența produsului/Αναφορά προϊόντος/Referența produsului

84723581 - EAN Code: 3276007468830
Industrial Type Design Reference: ISKENNG113

Marca del producto/Marca produsului/Μάρκα προϊόντος/Marca a produsului

INSPIRE

Código del número de serie/Codul numărului serie/Κωδικός αριθμού σειράς/Cod de număr de serie

NNNNNN-DDMMYYYY-DD (NNNNNN : the last 6 digits of the EAN code, DDMMYYYY : The date on which the order is created in the factory, DD : number of order

L'oggetto della dichiarazione di cui sopra è conforme alle pertinenti normative di armonizzazione dell'Unione Europea per le quali il prodotto presentato è stato progettato e realizzato in conformità con le norme armonizzate pertinenti. Il fabbricante si assume la responsabilità esclusiva della conformità del prodotto presentato alle norme armonizzate pertinenti. Il fabbricante si assume la responsabilità esclusiva della conformità del prodotto presentato alle norme armonizzate pertinenti. Il fabbricante si assume la responsabilità esclusiva della conformità del prodotto presentato alle norme armonizzate pertinenti.

Referența este pertinentă normelor armonizate utilizate și este specificată în declarația de conformitate. În ceea ce privește declarația de conformitate, este responsabil doar proiectantul și realizatorul produsului prezentat. Fabricantul este responsabil exclusiv pentru conformitatea produsului prezentat cu normele armonizate relevante. Fabricantul este responsabil exclusiv pentru conformitatea produsului prezentat cu normele armonizate relevante. Fabricantul este responsabil exclusiv pentru conformitatea produsului prezentat cu normele armonizate relevante.

Dove applicabile: Il nome e il numero del laboratorio notificato che ha rilasciato la certificazione e l'elemento al documento di documentazione appropriata * applicabile a nome e numero del laboratorio, viene scritto con chiarezza sul documento di documentazione. Il numero del laboratorio viene scritto con chiarezza sul documento di documentazione. Il numero del laboratorio viene scritto con chiarezza sul documento di documentazione. Il numero del laboratorio viene scritto con chiarezza sul documento di documentazione.

2014_03_EU_RED

aparechiate radiofrecvență radiofrecvență (emisiune de radiofrecvență)

EN 62368-1:2014 + A1:2017
EN IEC 55015:2015 + A11:2020
EN IEC 61000-2:2015 + A1:2021
EN 61000-3-2:2013 + A1:2019 + A2:2021
EN 61327-2:2009
EN 60908-2:2018
ETSI EN 300 328 V2.2.2 (2019-07)
ETSI EN 301 494-1 V2.2.3 (2019-11)
ETSI EN 301 494-1 V2.2.4 (2020-03)
EN 55632-2015/A1:2020
EN 55635-2017/A1:2020
EN 62475:2019
EN 50663:2017

2011_05_EU_RHS

Restricțiile de substanțe periculoase în aparatură electrică/Organizarea restricțiilor de substanțe periculoase în aparatură electrică/Organizarea restricțiilor de substanțe periculoase în aparatură electrică/Organizarea restricțiilor de substanțe periculoase în aparatură electrică/Organizarea restricțiilor de substanțe periculoase în aparatură electrică

RoHS Directive (EU)2015/863 amending Directive 2011/65/EU
EN 62321-2:2014
EN 62321-1:2014
EN 62321-6:2014/A1:2017
EN 62321-6:2015
EN 62321-1:1-2015
EN 62321-7:2-2017
EN 62321-8:2017
EN IEC 62000-2018

Completat, firmat în vigoare și parafat de către persoana responsabilă în întregime/Completat, firmat și parafat de către persoana responsabilă în întregime/Completat, firmat și parafat de către persoana responsabilă în întregime/Completat, firmat și parafat de către persoana responsabilă în întregime/Completat, firmat și parafat de către persoana responsabilă în întregime

Eric LEMOINE
International Project Quality Leader

Lugul și data deliberării/Datea yării și țării/Datea yării și țării/Datea yării și țării/Datea yării și țării/Datea yării și țării

Ronchin France
11/10/2022

84723581
3276007468830
INSPIRE



- FR** Ce produit est recyclable. S'il ne peut plus être utilisé, veuillez l'apporter dans un centre de recyclage de déchets.
- ES** Este producto es reciclable. Si ya no se puede usar, llévelo a un centro de reciclaje de residuos.
- PT** Este produto é reciclável. Se deixar de o utilizar, entregue-o num centro de reciclagem de resíduos.
- IT** Questo prodotto può essere riciclato. Se deve essere smaltito, portalo presso un centro di riciclaggio.
- EL** Αυτό το προϊόν είναι ανακυκλώσιμο. Εάν δεν μπορεί πλέον να χρησιμοποιηθεί, μεταφέρετε την σε κάποιο κέντρο ανακύκλωσης απορριμμάτων.
- PL** Ten produkt poddawany jest recyklingowi, kiedy przestaje być użyteczny należy dostarczyć go do punktu zbiórki odpadów.
- UA** Цей продукт може перероблятися. Якщо воно більше не є придатне для використання, здайте його в утилізаційний центр.
- RO** Acest produs este reciclabil. Dacă nu mai poate fi folosit, vă rugăm să îl aduceți într-un centru de reciclare a deșeurilor.
- BR** Este produto é reciclável. Se não puder mais ser usado, descarte em um centro de reciclagem de resíduos.
- DE** Dieses Produkt ist recycelbar. Wenn es nicht mehr verwendet werden kann, bringen Sie es bitte zum Recycling-Center.
- EN** This product is recyclable. If it cannot be used anymore, please take it to waste recycling centre.



Traduction de la version originale du mode d'emploi / Traducción de las Instrucciones originales / Tradução das Instruções Originais / Traduzione delle istruzioni originali / Μετάφραση των πρωτότυπων οδηγιών / Tłumaczenie instrukcji oryginalnej / Переклад оригінальної інструкції / Traduce reia instrucțiunilor originale / Tradução das Instruções Originais / Original-Anleitung / Original Instructions.

Made in China
Країна походження: Китай

EU ADEO Services - 135 Rue Sadi Carnot - CS00001 - 59790 RONCHIN - FRANCE

UA ТОВ «Адео Сервісез С.А.», вул. Саді Карно, CS 00001, 59790 Роншен, Франція.

ZA Imported by Adeo South Africa (PTY) LTD T/A Leroy Merlin, Hosted in Leroy Merlin Fourways Store 35 Roos Street, Witkoppen Ext 97, Sandton, 2191 Johannesburg, Gauteng, South Africa. Tel: +27 10 493 8000 Email: contact@leroymerlin.co.za.

BR IMPORTADO E DISTRIBUÍDO POR: LEROY MERLIN
COMPANHIA BRASILEIRA DE BRICOLAGEM CNPJ:
01.438.784/0001-05 Rua Pascoal Pais, nº. 525, 6º andar,
cj 61 a 64 - Vila Cordeiro, São Paulo - SP CEP: 04581-060
CALM (Central de Atendimento Leroy Merlin) Capitais
4020-5376 Demais Regiões 0800-0205376