

EAN : 3276007631999 / 3276007632019  
BD08SYON1000/BD08SYON2000

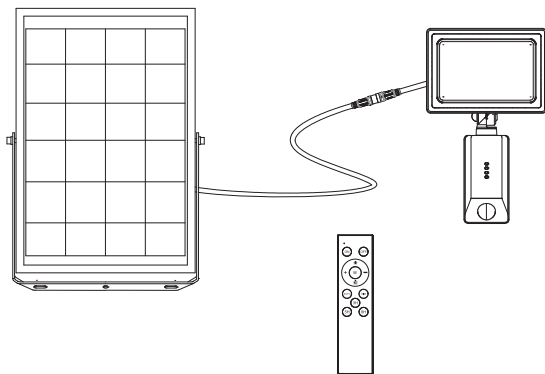

2/2



2023-09-V01

**FR** Manuel d'Instructions

**EL** Εγχειρίδιο Οδηγιών

**BR** Manual de Instrução

**ES** Manual de Instrucciones

**PL** Instrukcja Obsługi

**DE** Anleitung Handbuch

**PT** Manual de Instruções

**UA** Інструкція з Експлуатації

**EN** Instructions Manual

**IT** Manuale di Istruzioni

**RO** Manual de Instrucțiuni



FR: Montage / ES: Montaje / PT: Montagem / IT: Montaggio / EL: Συναρμολόγηση /  
PL: Montaż / UA: Збірка / RO: Montaj / BR: Montagem / DE: Montage / EN: Assembly



FR: Utilisation / ES: Utilización / PT: Utilização / IT: Uso / EL: Χρήση / PL: Użytkowanie  
/ UA: Використання / RO: Utilizare / BR: Utilização / DE: Verwenden Sie / EN: Use

**FR: CARACTÉRISTIQUES TECHNIQUES / ES: CARACTERÍSTICAS TÉCNICAS / PT: CARACTERÍSTICAS TÉCNICAS / IT: CARATTERISTICHE TECNICHE / EL: ΤΕΧΝΙΚΑ ΧΑΡΑΚΤΗΡΙΣΤΙΚΑ / PL: DANE TECHNICZNE / UA: ТЕХНІЧНІ ХАРАКТЕРИСТИКИ / RO: CARACTERISTICI TEHNICE / BR: CARACTERÍSTICAS TÉCNICAS / DE: TECHNISCHE CHARAKTERISTIKA / EN: TECHNICAL CHARACTERISTICS**



A1.



A4.



A5.



A6.



A10.



A7.



A13.



A17.



A26.



E1.



A20.



A21.



E2.

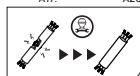

T1.



T10.



T12.

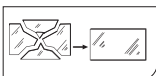

A27.



BD08SYON1000



BD08SYON2000



A37.

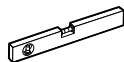
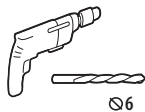
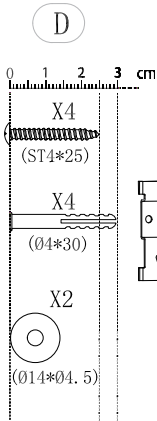
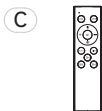
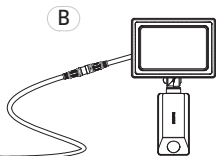
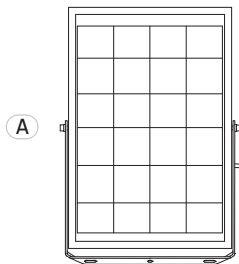



# 1

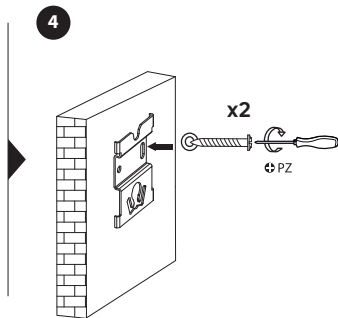
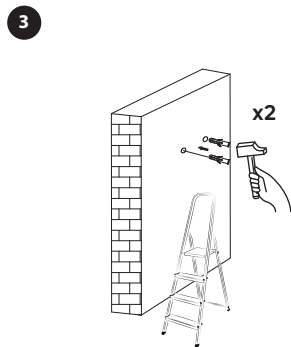
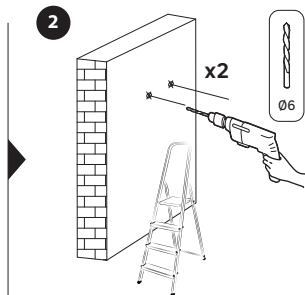
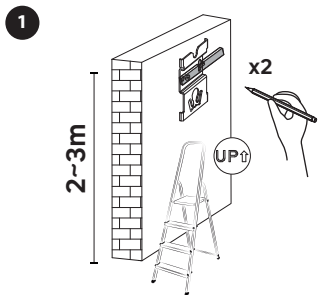

# 2

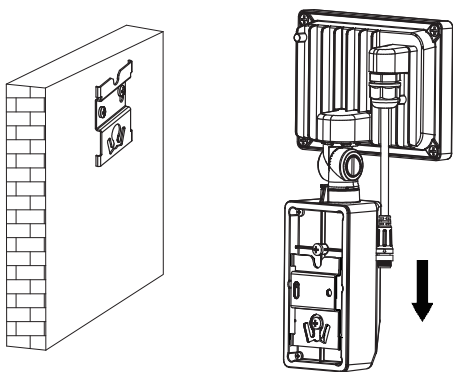

# 3

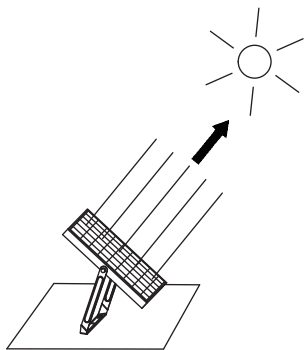

# 4

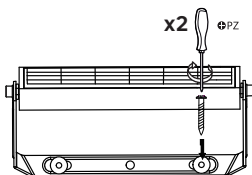
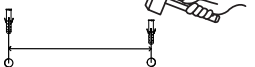
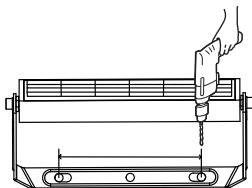
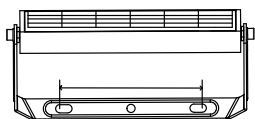

x2



# 5

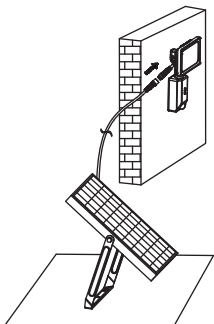

# 6

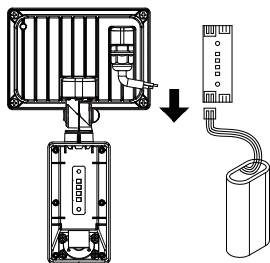
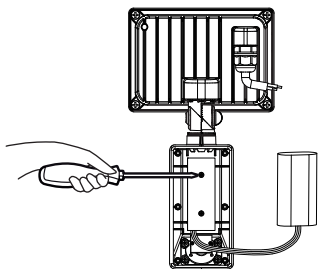
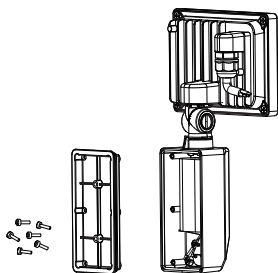
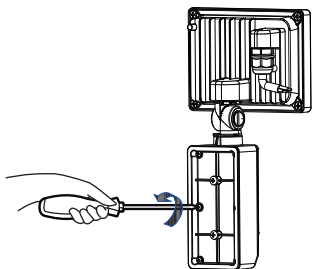



1

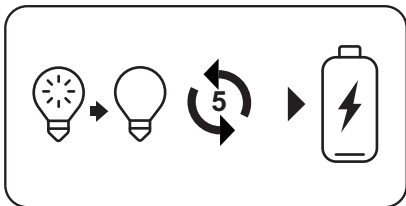
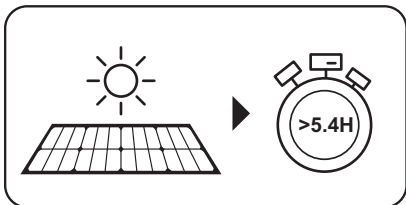
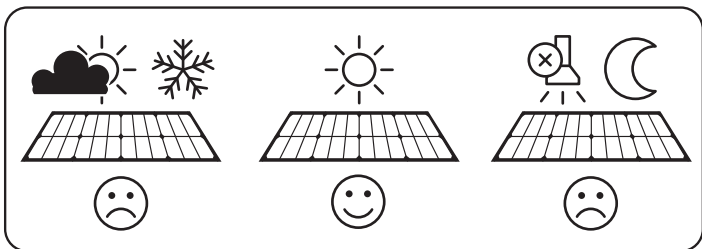



# 2

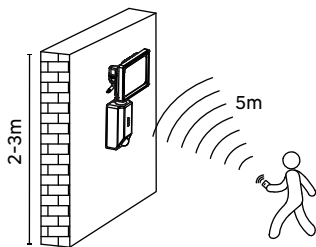
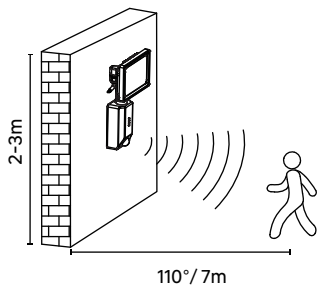

# 3

## 1

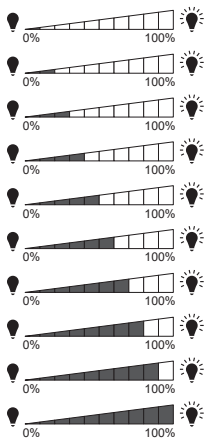
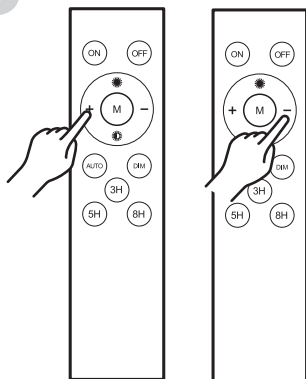

2

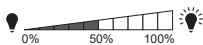
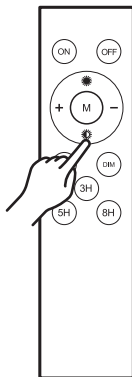
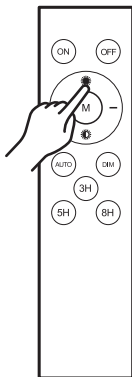

3

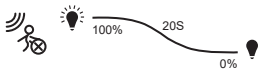
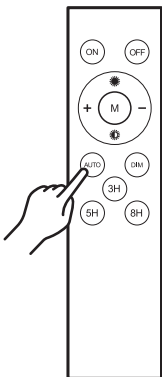

4

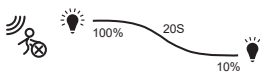
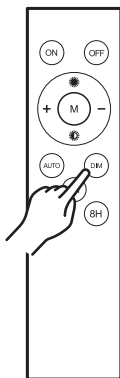

5

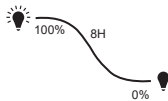
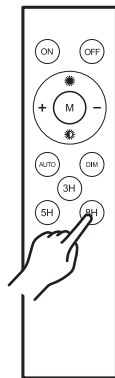
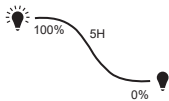
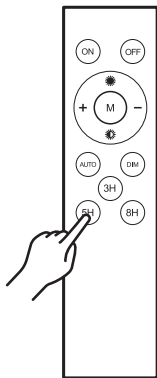
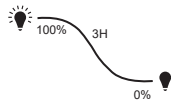
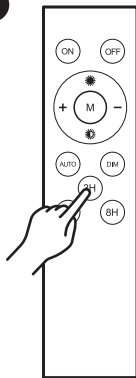

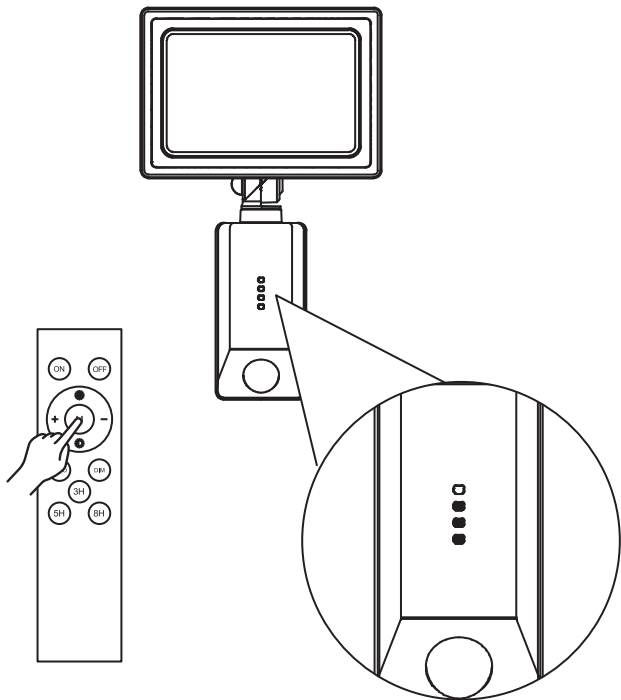



- FR** Ce produit est recyclable. S'il ne peut plus être utilisé, veuillez l'apporter dans un centre de recyclage de déchets.
- ES** Este producto es reciclable. Si ya no se puede usar, llévelo a un centro de reciclaje de residuos.
- PT** Este produto é reciclável. Se deixar de o utilizar, entregue-o num centro de reciclagem de resíduos.
- IT** Questo prodotto può essere riciclato. Se deve essere smaltito, portalo presso un centro di riciclaggio.
- EL** Αυτό το προϊόν είναι ανακυκλώσιμο. Εάν δεν μπορεί πλέον να χρησιμοποιηθεί, μεταφέρετε την σε κάποιο κέντρο ανακύκλωσης απορριμμάτων.
- PL** Ten produkt poddawany jest recyklingowi, kiedy przestaje być użyteczny należy dostarczyć go do punktu zbiórki odpadów.
- UA** Цей продукт може перероблятися. Якщо воно більше не є придатне для використання, здайте його в утилізаційний центр.
- RO** Aceast produs este reciclabil. Dacă nu mai poate fi folosit, vă rugăm să îl aduceți într-un centru de reciclare a deșeurilor.
- BR** Este produto é reciclável. Se não puder mais ser usado, descarte em um centro de reciclagem de resíduos.
- DE** Dieses Produkt ist recycelbar. Wenn es nicht mehr verwendet werden kann, bringen Sie es bitte zum Recycling-Center.
- EN** This product is recyclable. If it cannot be used anymore, please take it to waste recycling centre.



FR Traduction de la version originale du mode d'emploi / ES Traducción de las Instrucciones originales / PT Tradução das Instruções Originais / IT Traduzione delle istruzioni originali / EL Μετάφραση των πρωτότυπων οδηγιών / PL Tłumaczenie instrukcji oryginalnej / UA Переклад оригінальної інструкції / RO Traducerea instrucțiunilor originale / BR Tradução das Instruções Originais / DE Übersetzung der Originalversion der Gebrauchsanweisung / Original Instructions.

Made in China

Країна походження: Китай

**EU** ADEO Services - 135 Rue Sadi Carnot - CS00001 - 59790 RONCHIN - FRANCE

**UA** Виробник: ТОВ "Адео Сервісез С.А.", вул. Саді Карно, CS 00001, 59790 Роншен, Франція.

Імпортер: ТОВ "Леруа Мерлен Україна", 04201 Україна, м. Київ, вул. Полярна 17А, +380 44 498 46 00. Імпортер приймає претензії від споживачів щодо товару, а також проводить його ремонт, технічне і гарантійне обслуговування

**BR** LEROY MERLIN COMPANHIA BRASILEIRA DE BRICOLAGEM CNPJ: 01.438.784/0001-05  
Rua Pascoal Pais, nº. 525, 6º andar cj 61 a 64,  
Vila Cordeiro, São Paulo - SP. CEP: 04581-060  
CALM (Central de Atendimento Leroy Merlin)  
Capitais 4020-5376 Demais Regiões  
0800-0205376

**ZA** Imported by Adeo South Africa (PTY) LTD T/A Leroy Merlin,  
Hosted in Leroy Merlin Fourways Store 35 Roos Street,  
Witkoppen Ext 97, Sandton, 2191 Johannesburg, Gauteng,  
South Africa.  
Tel: +27 10 493 8000 Email: contact@leroymerlin.co.za.